

EPURE

LED surgical lights
A fusion of design and innovation



Surgiris

Design that cares



Operating theatre

CHANGE YOUR VISION / EPURE



EPURE lights are truly innovative LED surgical lights. Designed and manufactured by Surgiris, they feature the exclusive and patented **FOCUSMATIC** and **MOTION-MATIC** technologies as well as intelligent LED management and control.

Compact and reliable, EPURE surgical lights offer **excellent value for money, making innovation accessible to all.**

TECHNOLOGICAL INNOVATION

Change your vision – discover innovative lighting systems.

Patented FOCUSMATIC system

Equipped with sophisticated electronic management of the LEDs and combined with an individual optical device for each LED, FOCUSMATIC technology revolutionizes the “focus” function of the surgical lights.



It allows the adjustment of the illuminated field diameter up to a very large spot size with no loss of central lighting intensity.

- Up to **160 000 Lux** with an illuminated spot adjustable up to a diameter of **26cm**.

Thanks to Surgiris unique technology, the central illumination (E_c) remains constant regardless of the illuminated field diameter.

Illuminated spots obtained with :

 LED lighting with classic focalization system

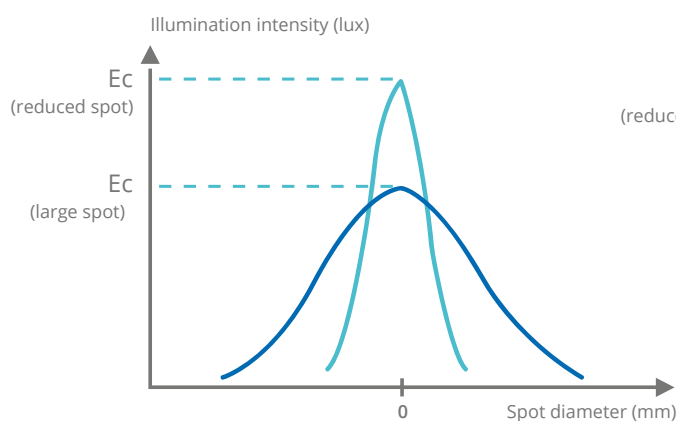

 SURGIRIS LED lighting with patented FOCUSMATIC system

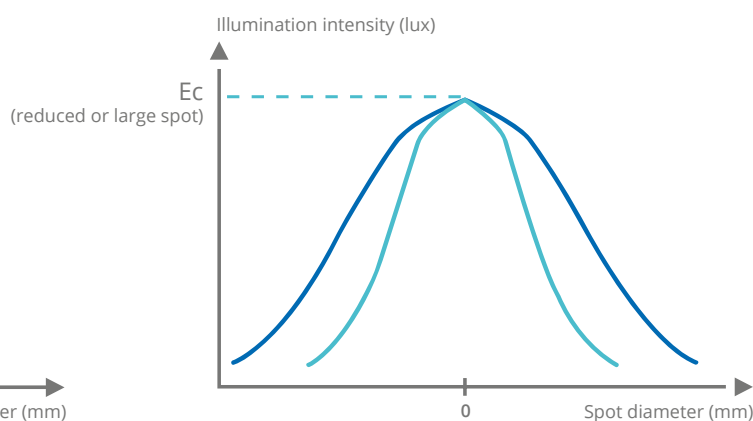

- Maximum focal length, large spot
- Minimum focal length, reduced spot



TECHNOLOGICAL INNOVATION

Patented MOTION-MATIC system

EPURE surgical lights are the only surgical lights based on the innovative patented MOTION-MATIC technology.



Gesture control

Equipped with 3 optical cells, EPURE surgical lights allow to **set up the 3 parameters of lighting without touching the cupola :**

- ◆ Luminous intensity
- ◆ Focus
- ◆ Colour temperature

The surgeon, the assistant and the nurses can directly adapt the lighting to their needs.



To prevent unintended changes, the MOTION-MATIC intelligent system tracks down the hand in a 5cm area around the sensor and switches off automatically when the cupola is moved.



A design that makes users' everyday life easier

The EPURE cupola has been specially designed with a smooth and flat surface without any visible screw. Cleaning and disinfection are facilitated and simplified.

A gripping groove surrounds the cupola to ensure better handling by the staff.

The EPURE is made of an aluminum structure covered with an innovative polyester specifically designed to meet the constraints of the operating room :

- ◆ Resistance to disinfection products
- ◆ Excellent shock absorption
- ◆ No yellowing over time
- ◆ Fire and heat resistance (5VA index)

DESIGN

◆ The EPURE is a LED surgical light with an array of eight, 4-LEDs modules.

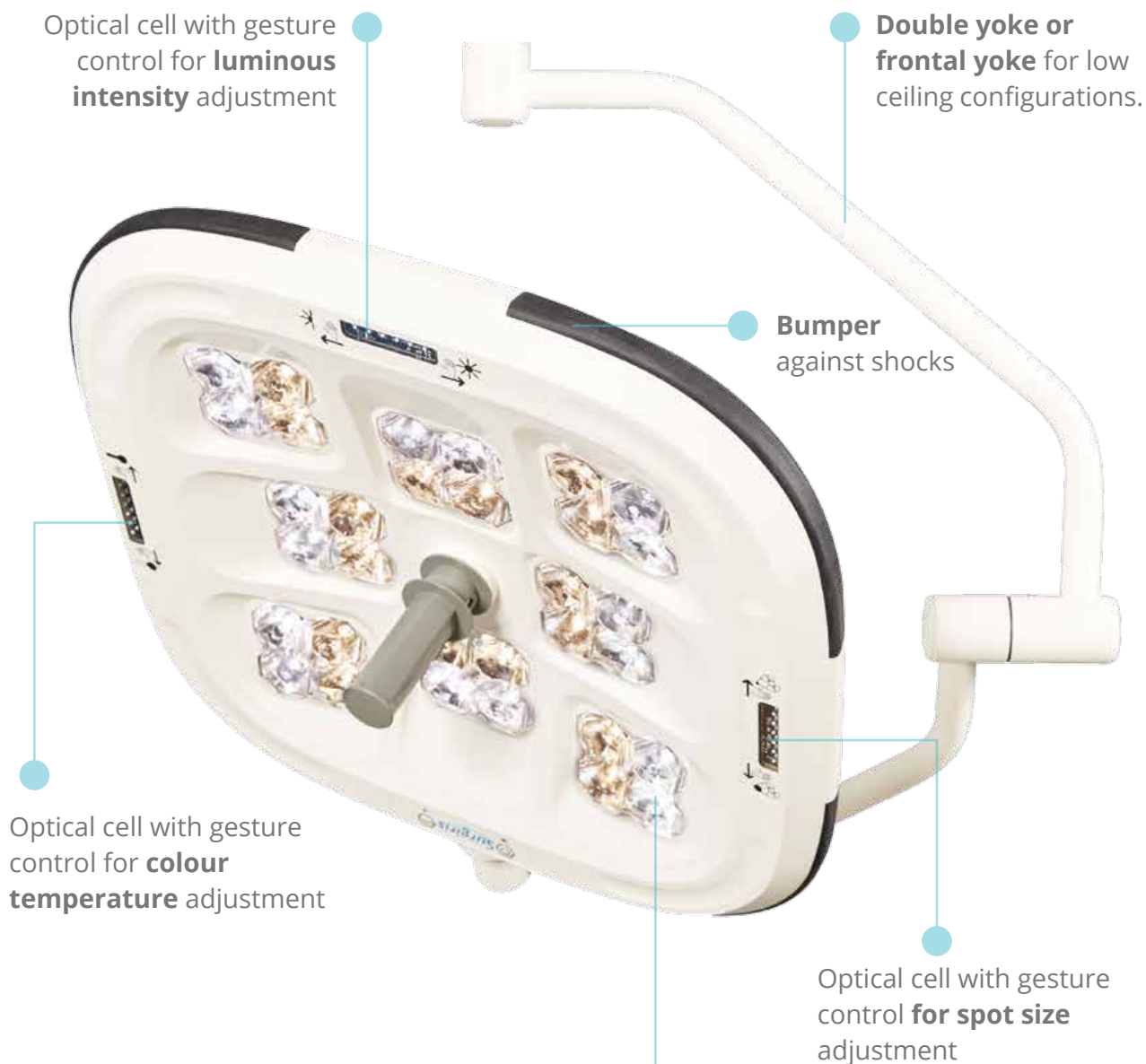

LED module:
the LED clusters maintain the central illuminance – regardless of illuminated field diameter, the colour temperature and provide a Ra of 96.

INTELLIGENT LED CONTROL

Managed, protected and controlled electronically, each LED is a genuine concentrate of technology :



CCL: maintains performance throughout the LEDs life time



EFA: electronic focalization system, adjustment of the diameter of the illuminated spot without mechanical movement



APM: automatic preventive maintenance for the LEDs



WCT: wireless communication

Maintaining lighting performance

The LEDs electronic control is configured so as to maintain constant luminous intensity and colour temperature throughout each surgical procedure. These are maintained continuously, even after several hours' operation.

LED lighting without CCL*

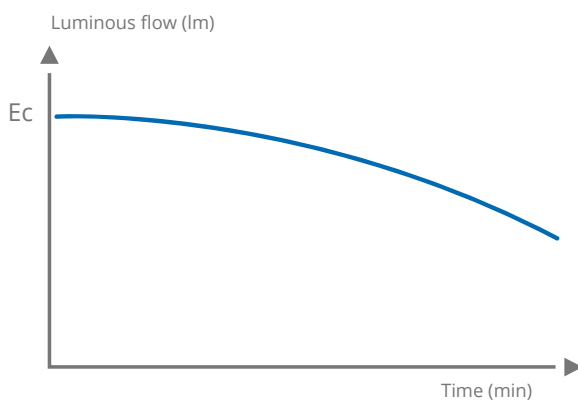

SURGIRIS LED lighting with CCL

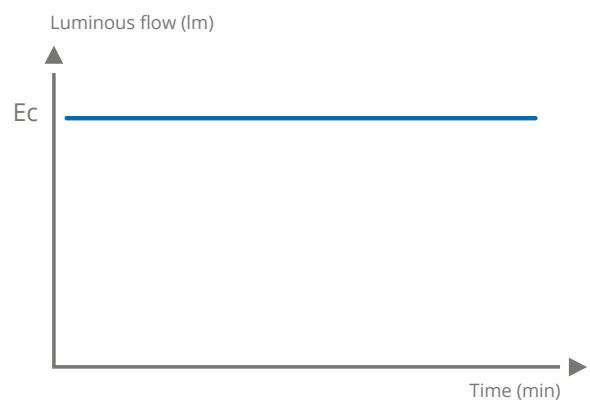

* or other system of LED luminous flow management

Colour reproduction

The combination of latest generation white LEDs (warm white and cold white) provides a high colour rendering index (Ra) and a very good rendering of red color (R9). The colour temperature is adjustable from 3500K to 4500K.

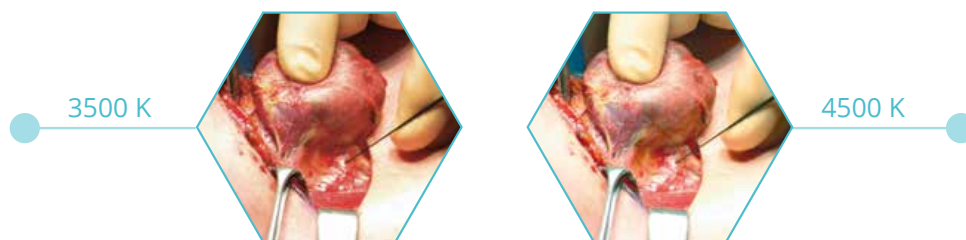

Large depth of field

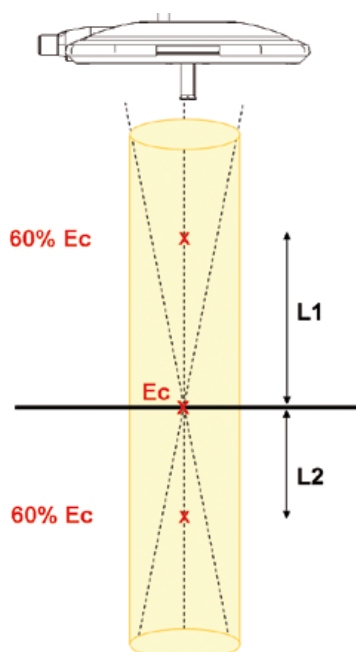

- EPURE lights are suitable for illumination of deep cavities.
- At 60% Ec, $L1+L2 = 77$ cm

Optical independence of each module

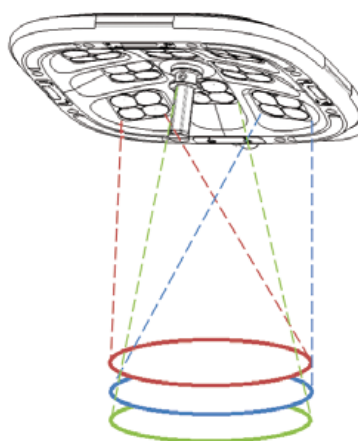

- Each LED module is optically independent from the others and is designed to illuminate a full spot at a distance of 1m.
- The optical independence of the LED modules improves **shadows dissolution and ensures excellent homogeneity** of colours and light.

ENDO Mode

The standard functions of the EPURE lights include an ENDO mode. The ENDO mode allows the diffusion of ambient light suitable for performing procedures under imaging guidance and control : endoscopic and laparoscopic.

MAINTENANCE AND LIFETIME

EPURE lights are designed for a long life. Their innovative design, the selection of latest-generation high-performance LEDs, and the electronic control system contribute to the reliability of the SURGIRIS lights.

Focalization without mechanical movement



One of the advantages of the FOCUSMATIC (patent pending) technology is the ability to provide focalization with no mechanical movement. Unlike most surgical lights, EPURE cupolas, designed and manufactured by SURGIRIS, do not include moving parts subject to wear and tear. This means that maintenance is greatly reduced.

Preventive maintenance of the LEDs by electronic management



The APM is an automatic preventive maintenance system integrated in the lighting cupola. The LEDs are controlled and protected continuously by a microprocessor that provides management and control.

The CCL function also includes **electronic management of LED aging.**



Meticulous design

EPURE surgical lights are designed and manufactured in France by SURGIRIS.

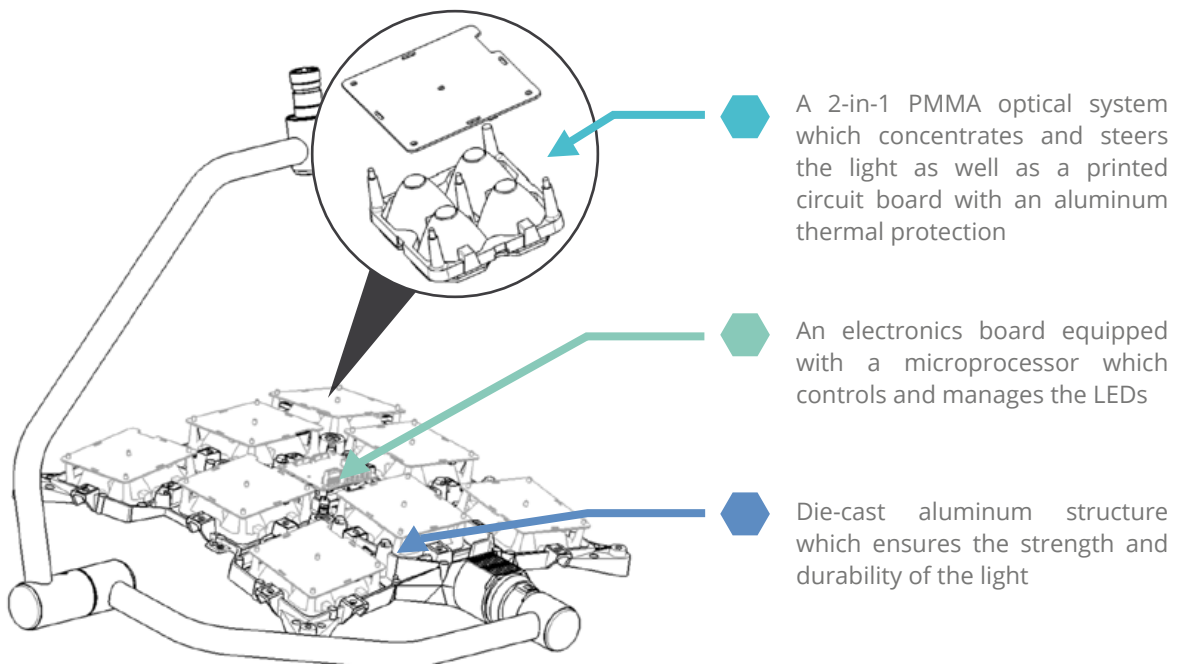

VIDEO SOLUTIONS

HD Plug'n Play Camera

A High Definition camera can be plugged in the center of the cupola or to the suspension system to capture images for teaching or documentation archiving.

◆ HD image quality

◆ Wireless controls



Image transfer

E-comot Packs



Solutions for :

Streaming • Video over IP • Videoconference
Supervision • Recording and archiving

Integrated operating theatres

The lighting and the video camera can also be controlled through most of the integration solutions for operating theatres. SURGIRIS collaborates with partners specialized in OR integration in order to offer you a solution adapted to your needs.

SURGIRIS offers a range of HD monitors complementing the support arms for image display.

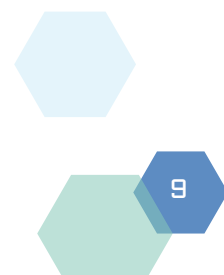

MAIN OPTIONS



Remote control

Wall-mounted panel to control the lighting system through wireless communication technology.



Support for single-use handle



Backup supply

"EMERGILED" combines a power supply and a backup power supply in a single box. In case of mains power failure, switchover to the backup is done instantly* with no loss of lighting level.

* floating switchover without relays

TECHNICAL GUIDE

Available configurations

◆ Ceiling-mounted

Ceiling-mounted suspensions allow unlimited rotation and integration of arms for a camera or monitors, in addition to the lighting cupolas.

Single light

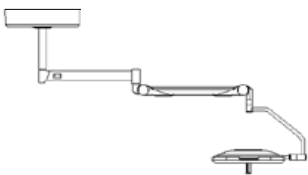

Double light

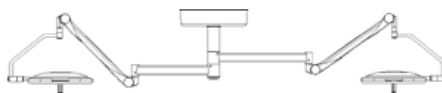

Double light with monitor

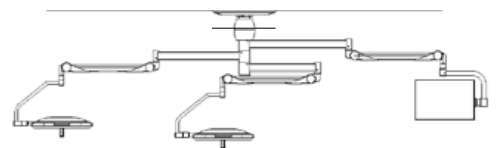

Triple light

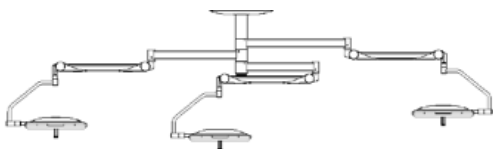

These configurations are presented as examples. Other configurations are also possible. Please consult us for a personalized proposal.

◆ Wall-mounted

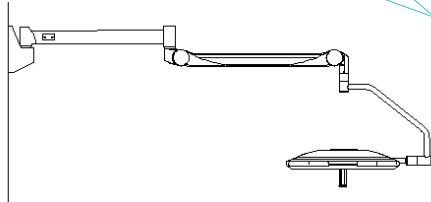

◆ Mobile

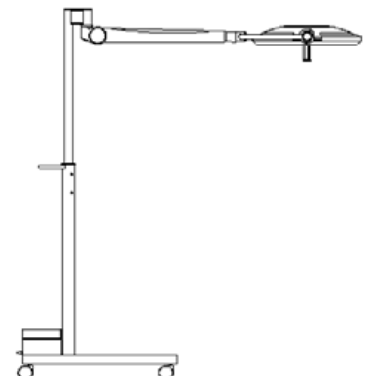

TECHNICAL DATA

EPURE

Light source	LED
Maximum central lighting (Ec)*	160 000 Lux
Adjustable illumination intensity*	From 50 000 to 160 000 Lux
Endoscopy mode : "ENDO"	Yes
D10*	26 cm
D50*	18 cm
Depth of field L1+L2 (60% Ec) 2008*	77 cm
Depth of field L1+L2 (20% Ec) 2003*	128 cm
Focalization	 FOCUSMATIC Patent <ul style="list-style-type: none"> • Electronically adjustable diameter of the illuminated field, with constant central illumination • With no mechanical movement
Lighting control by the sterile staff	 MOTION-MATIC Patent Gesture control of the 3 lighting parameters (light intensity, focus, colour temperature)
Colour rendering index Ra*	96
R9**	96
Colour temperature*	3500 to 4500 K
LED life time	60 000 h
HD video preparation	Optional
Dimension	59x59cm

* Typical values recorded under control by a notified body, at a distance of 1m, in accordance with norm IEC 60601-2-41 (tolerance 0% to -10%). These values are subject to modification in view of the technical evolution of the products and the updates

** Value recorded at 3500K

EPURE surgical lights are designed and manufactured in France by SURGIRIS and comply with the standards IEC 60601-1, IEC 60601-1-2 and IEC 60601-2-4.



Select a meticulous design

SURGIRIS is a French designer and manufacturer offering a wide range of LED surgical lights, ceiling pendants and distribution columns for OT, ICU & CCU. For more information, visit www.surgiris.com

Surgiris

Design that cares

Registered Office, Factory and R&D SURGIRIS

80 rue de la Gare • 59170 Croix • France

Tél : +33 (0)3.20.16.07.93 • Fax : +33 (0)3.20.95.40.19 • Mail : info@surgiris.com



MADE IN FRANCE