

**üzümcü**





üzümcü

# OPERATING TABLES & ACCESSORIES

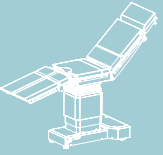

OPERATING  
TABLES  
&  
ACCESSORIES



We are better together  
We enable you to treat your patients  
on the best tables.

üzümcü

# OPERATING TABLES

## Electrical Movements

- Height
- Back Rest
- Trendelenburg
- Reverse Trendelenburg
- Lateral Tilt
- Sliding

## Mechanical Movements

- Head Rest
- Kidney Surgery Position
- Leg Rests, Up / Down
- Leg Rests, Right / Left
- Central Locking

## Sizes

- Width x Length : 610x2080 mm (OM-9T)
  - Width x Length : 610x2200 mm (OM-6N)
  - Height (min) : 845 mm (800 mm OM-6N)
  - Height (max) : 1240 mm (1200 mm OM-6N)
- \*Max. - min. dimensions are measured with mattress.*

Üzümcü OM-9T and OM-6N operating tables are designs which can be adjusted to get positions suitable for carrying out all surgical operations, produced by considering the patient and user requirements and maximize the operational efficiency.



• Optimal Clearance in Surgical Area

• Rapid Mobilization

• Mattress options ensuring patient's comfort

<OM-9T



# OM-9T / OM-6N

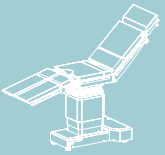

OPERATING  
TABLES  
&  
ACCESSORIES

## Angles

• Sliding Movement	: 300 mm	• Leg Rest Up / Down	: +60°/-85° (+65°/-80° OM-6N)
• Lateral Tilt Movement	: +20°/- 20°	• Leg Rest Parallel Movement	: 90°
• Back Rest Movement	: +70°/- 25° (+90°/- 40° OM-6N)	• Head Rest Movement	: +35° / - 80°
• Trendelenburg	: +25°	• Kidney Surgery Position	: 300°
• Reverse Trendelenburg	: -25°	• Flex / Reflex Position	: 210° / 115°



Nano surface protection technology is easy to clean, highly resistant to corrosion and has an antibacterial effect that prevents the production and inhabitation of blood and body fluids on the surface.



# OPERATING TABLES

## Detailed Specifications



### < Functional Design & Wide Range of Accessory Options

- Modular design taking shape by different surgical operations with high stability
- Solutions ensuring to reach the position required by any kind of surgical operations with its wide range of accessory options
- Telescopic body specifications enabling height adjustment at different levels
- Wheel system which is made of ABS plastic, with high multi-directional mobility and 125 mm in diameter (OM-9T)



### < Sliding

- Image reception ability in a wide area without disturbing the sterile environment with the flouroscopy device by its slideability within 300 mm on horizontal plane

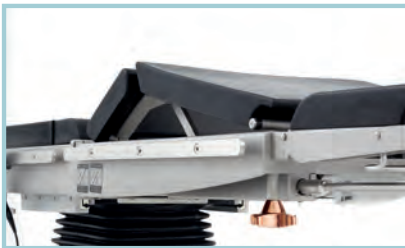

### < Optimal Clearance In Surgical Area

- Maximum surgical area visibility and operational success with kidney surgical elevator integrated on the table and can be adjusted up to 295°(120 mm)



### < Different Mattress Options

- High-quality image reception facility with table top made of compact material with high x-ray permeability
- Visco or polyurethane mattress options ensuring patient comfort by taking shape of body parts of patient and preventing decubitus prophylaxis
- Cleanable and sterilizable mattress for decontamination of operating room with its seamless structure and demountability



### < Modular Design

- Design that can get different angles according to the operation's kind, demountable head and foot plates
- Design consisting of one, two or four parts and suitable for connecting foot plate
- Unlimited perineal accessibility with demountable foot plate

# OM-9T / OM-6N

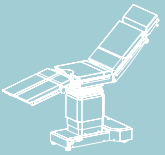

OPERATING  
TABLES  
&  
ACCESSORIES



## < Easy Approach For C-Arm

- Possibility to have high image quality from all parts of the table with X-ray permeable table top.
- Suitable base structure for easy access and approach of the C-arm scopy and surgical microscopes



## < Accessory Positioning

- Attachment system mountable on stainless steel rail integrated on both sides of the table, enabling connecting a new accessory without demounting existing accessories and preventing loss of time.



## < T Base Specifications

- T Base enabling surgical team and equipment to approach the table optimally and contributing to operational success
- 316 quality stainless steel body resistant to fractures and corrosion
- Silent and nonvibrating operation



## < Remote Control

- Rapid recall in case of need by storing five different surgery positions
- Position reset by a single button
- Hand, body and remote control system ensuring easy use in endosurgery operations thanks to the illuminated screen

## OM-9T Extra Functions



Wheel system increasing mobility



3-layer visco elastic mattress ensuring patient comfort

# OPERATING TABLES

## Mechanical Movements

- |                         |                           |
|-------------------------|---------------------------|
| • Height Adjustment     | • Lateral Tilt Movement   |
| • Back Rest             | • Head Rest Movement      |
| • Trendelenburg         | • Leg Rests, Up / Down    |
| • Reverse Trendelenburg | • Leg Rests, Right / Left |

## Sizes

- |                  |                 |
|------------------|-----------------|
| • Width x Length | : 610 x 2150 mm |
| • Height (min)   | : 735 mm        |
| • Height (max)   | : 985 mm        |

\*Max. - min. dimensions are measured with mattress.



Üzümcü OM-2M table offers suitable solutions for every surgery branch and budget, it is a model easy to use, long-lasting with low cost and enables all positions mechanically.



\*Height adjustment with electrical motor in telescopic body (OM-2ME)





# OM-2M / OM-2ME\*

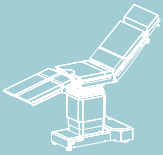

OPERATING  
TABLES  
&  
ACCESSORIES

## Angles

• Lateral Tilt Movement	: +30°/- 30°	• Leg Rest Up / Down	: +60°/-85°
• Back Rest Movement	: +70°/- 35°	• Leg Rest Parallel Movement	: 90°
• Trendelenburg	: +20°	• Head Rest Movement	: +35° / -80°
• Reverse Trendelenburg	: -25°	• Flex / Reflex	: 215°/110°

## Detailed Specifications



### < Functional Design & Wide Range of Accessory Options

- Modular design taking shape by different surgery operations with high stability
- Solutions ensuring to reach the position required by any kind of surgery operations with its wide range of accessory options
- Telescopic body enabling height adjustment at different levels



### < Ergonomic Positioning Arms

- Trendelenburg/reverse trendelenburg and spine positioning arms that are easily accessible and enables ergonomic use



### < Table Top Specifications and Lateral Use

- Cleanability and sterilizability suitable for decontamination with its seamless structure and demountability
- High-quality image reception facility, table top being made of compact material with high x-ray permeability
- Right-left lateral tilt arm, practical to use and integrated with the operation table, enables mobility for the surgery team and can be hidden under table sitting plate when not in use



### < T-Base Specifications

- T-Base contributes to operational success by enabling optimal approach of surgery team and equipment to table
- 316 quality stainless steel body resistant to fractures and corrosion
- Silent and non-vibrating operation



### < Breaking System & Hydraulic Lever

- Wheel system enabling mobility in the operation room
- Brake system enabling positioning in the required position
- Telescopic body with height adjustment at required level by hydraulic pedal

# OPERATING TABLES



Trendelenburg Position



Reverse Trendelenburg Position



Left Lateral Tilt Position



Right Lateral Tilt Position



Reflex Position



Flex Position



Chest (Breast) Surgery Position



Struma Surgery Position



Bariatric Laparoscopic Surgery Position



Anaesthesia Preparation and General Surgery Position



Chest Surgery Position



Kidney, Sternum Surgery Position

# POSITIONS

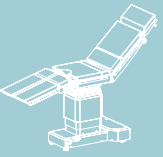

OPERATING  
TABLES  
&  
ACCESSORIES



Kidney Surgery Position



Gynecologic and Urologic  
Surgery Position



Gynecologic, Urologic, Colorectal  
Surgery Position



Spinal, Proctologic Surgery  
Position



Spinal Surgery Position



Neurosurgery Position



Neurosurgery Position



Neurosurgery Position



Arthroscopic Knee Surgery Position



Meniscus Surgery Position



Orthopedic Fracture Surgery  
Position



Ophthalmology Position

# OPERATING TABLES



OM-120 Arm Support  
A.C.: 11.1020



OM-110 IV Stand  
OM-100 Anaesthesia Screen\*  
A.C.: 11.1019 A.C.: \*11.1018



OM-150 Body Strap  
A.C.: 11.1021



OM-152 Hand-Wrist Strap  
S.K.: 11.1023



OM-155 Foot-Wrist Strap  
A.C.: 11.1024



OM-405 Clamp  
A.C.: 11.1105



OM-390 Clamp  
A.C.: 11.1027



OM-130 Shoulder Support (Pair)  
A.C.: 11.1022



OM-190 Lateral Support (Pair)  
A.C.: 11.1025

# ACCESSORIES

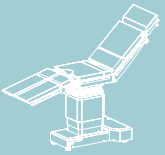

OPERATING  
TABLES  
&  
ACCESSORIES



OM-200 Foot Support (Pair)  
AC: 11.1026



OM-310 Proctological Accessories  
AC: 11.1033

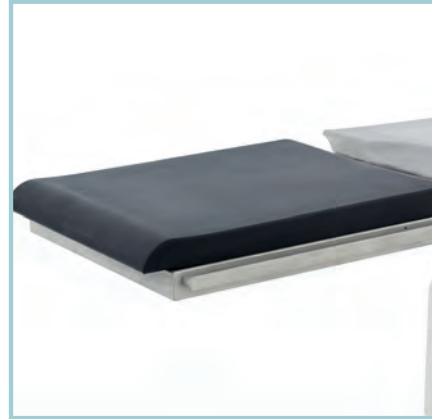

OM-255 Extension Leg Plate (Single)  
AC: 11.1039



OM-330 X-Ray Cassette Holder  
AC: 11.1040



OM-240 Knee Arthroscopy Support  
AC: 11.1037



OM-990 Accessory Trolley  
AC: 11.1043



OM-520 Orthopedic Traction Set  
AC: 11.1042



OM-250 Meniscus Positioning Roll  
AC: 11.1038

# OPERATING TABLES



OM-365 Arm Surgery Plate  
A.C.: 10.1041



OM-550 Orthopedic Traction Set  
Accessory Trolley  
A.C.: 11.1044



OM-270 Ophthalmologic head support  
A.C.: 11.1036



OM-285 Neurosurgery Head Rest With Pin  
& Horseshoe Head Rest  
A.C.: 11.1034



OM-300 Croos Bar  
A.C.: 11.1035



OM-380 Irrigation Bowl  
A.C.: 11.1032



OM-220 Geopel Knee Clutch (Pair)  
A.C.: 11.1030



OM-600 Leg Positioning Boot  
A.C.: 11.1063



OM-460 Mattress, Adult, Gel  
A.C.: 11.1050  
OM-450 Mattress, Pediatric, Gel  
A.C.: 11.1017

# ACCESSORIES

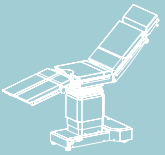

OPERATING  
TABLES  
&  
ACCESSORIES

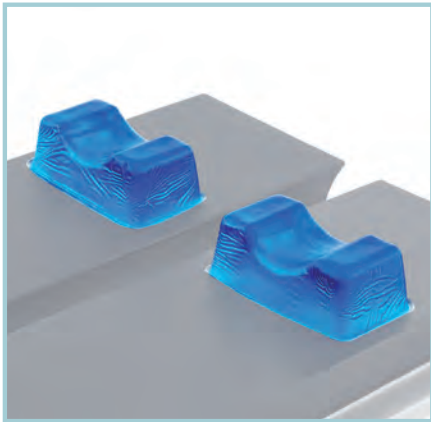

OM-428 Foot Wrist Rest, Gel  
AC: 11.1011

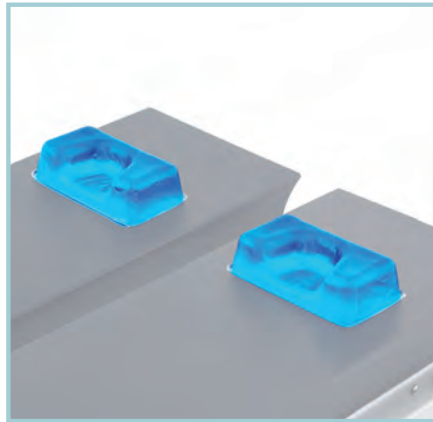

OM-425 Heel Rest, Gel  
AC: 11.1010

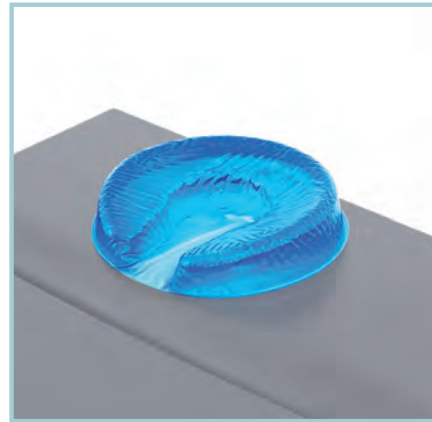

OM-410 Horseshoe Head Rest, Gel  
OM-412 Horseshoe Head Rest, Gel, Pediatric\*  
AC: 11.1007 \*AC: 11.1008

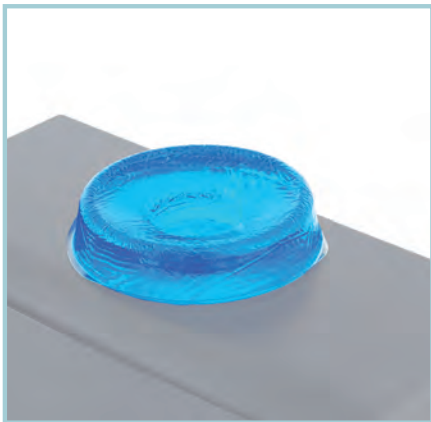

OM-430 Head Rest, Gel  
OM-432 Head Rest, Gel, Pediatric\*  
AC: 11.1012 \*AC: 11.1013

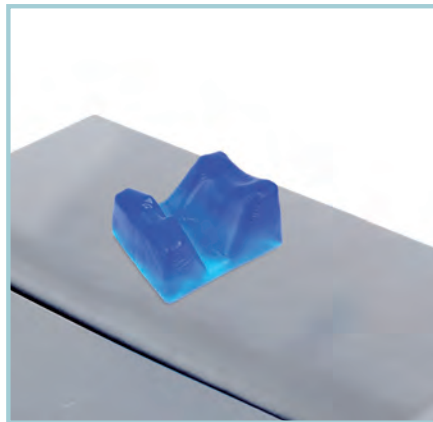

OM-415 Prone Head Support  
AC: 11.1102



OM-420 Arm Rest, Gel  
AC: 11.1009

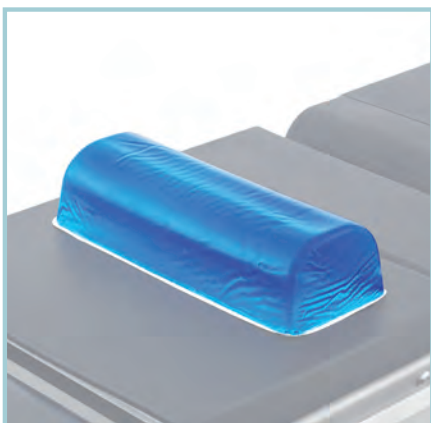

OM-440 Chest Cushion, Gel  
OM-442 Chest Cushion, Geli Pediatric\*  
AC: 11.1014 \*AC: 11.1015



OM-446 Spinal surgery cushion with silicone  
OM-447 \*Spinal surgery cushion without silicone  
AC: 11.1103 \*AC: 11.1104



OM-445 Silicon lateral position support  
AC: 11.1016

# C-ARM IMAGING TABLE

## Table Movements

- Height
- Multifunctional Table Top Slide
- Central Locking

## Mechanical Movements

- Central Locking

## Sizes

- Width x Length : 465x2450 mm
- Height (min) : 845 mm
- Height (max) : 1105 mm
- X axis movement : 800 mm
- Y axis movement : 220 mm

Üzümcü XT-30 and XT-15 imaging tables are models that enables excellent C-arm accessibility with non-metallic carbon fiber top tray and maximum imaging quality at low radiation, offering solutions for surgery and interventional radiology.

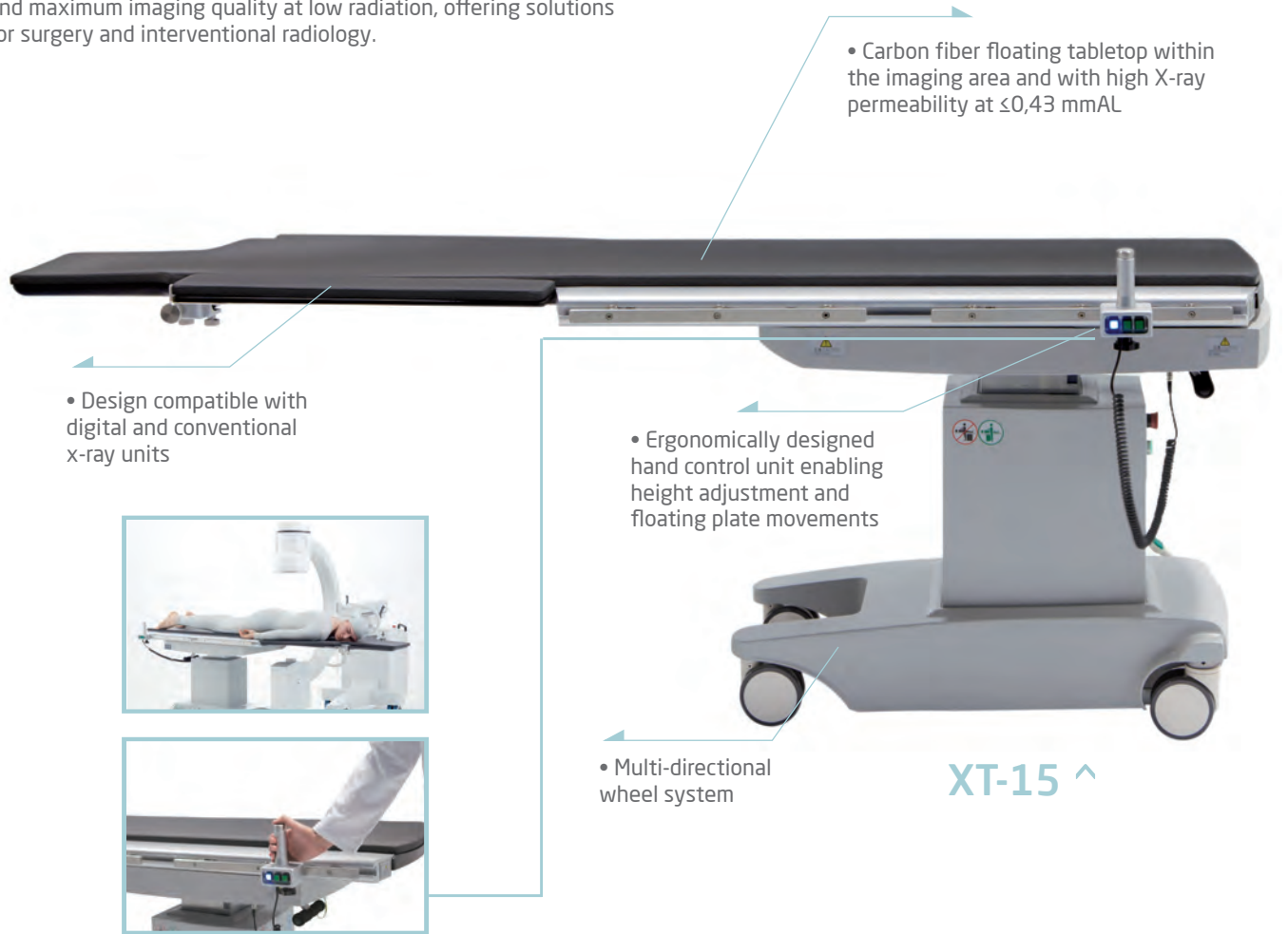

- Design compatible with digital and conventional x-ray units

- Carbon fiber floating tabletop within the imaging area and with high X-ray permeability at  $\leq 0,43$  mmAL

- Ergonomically designed hand control unit enabling height adjustment and floating plate movements

- Multi-directional wheel system

XT-15 ^

\*Hand control unit





# IMAGING & SPINE SURGERY TABLE

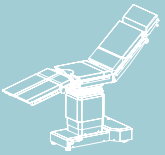

OPERATING  
TABLES  
&  
ACCESSORIES

## Electrical Movements

- Height Adjustment
- Trendelenburg
- Reverse Trendelenburg
- Lateral Tilt

## Mechanical Movements

- Central Locking
- Carbonfiber Spine Shelf

## Sizes & Angles

- Width x Length : 500x2000 mm
- Height (min) : 770 mm
- Height (max) : 1060 mm
- Lateral Tilt : 10° / -10°
- Trendelenburg : +26°
- Reverse Trendelenburg : -26°

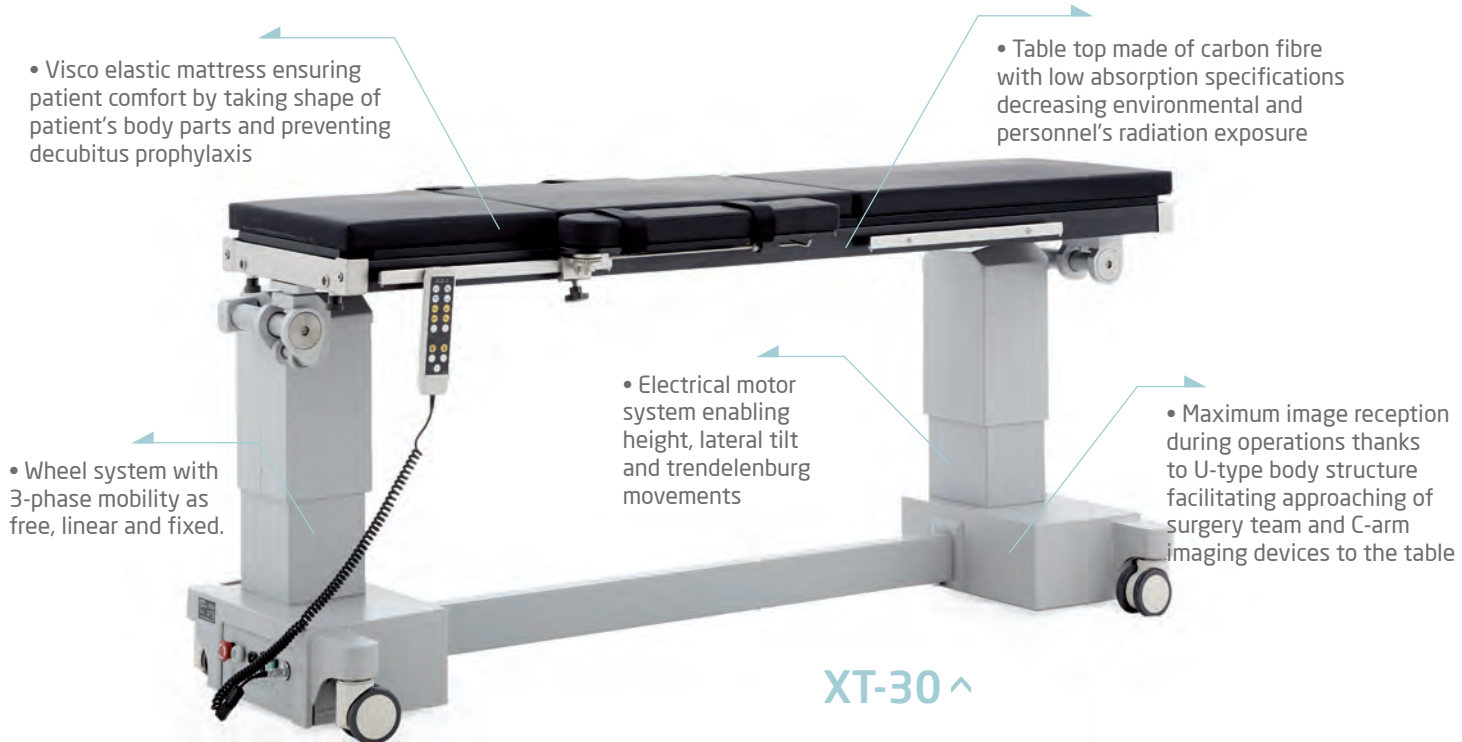

## Detailed Specifications



\*Carbonfibre table top



\* Spine surgery accessory with adjustable angle



\*U type body structure is ideal for easy image reception



# GYNECOLOGICAL TABLE

## Table Movements

• Height Adjustment : 720 - 970 mm  
• Back Rest : 50°

• Trendelenburg : 20°

*\*Max. - min. dimensions are measured with mattress.*

• Visco elastic seamless mattress ensuring hygiene conditions and patient comfort, can be easily cleaned in accordance with hospital decontamination rules

• Easily replacable leg and foot rest accessories can be used for different gynecological operations

• Durable steel body with electrostatic paint

Üzümcü JM-4F Gynecological Table is a model suitable for any kind of gynecological examination and operation, contributing visually to the operation environment with its different colour options.

• Ergonomic examination and diagnose possibility for the doctor

• Height adjustment, trendelenburg position and back section can be adjusted both by hand and foot control for easy and fast positioning



< JM-4F

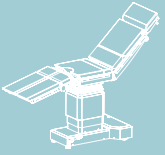

&lt; JM-BD



S.K.: 11.1049

&lt; JM-TD



S.K.: 11.1048

### Detailed Specifications

#### < Waste Collection

- Sustainable hygiene conditions with waste collection system, which is easy to clean and disinfect, thanks to the round concave structure



#### < Hygiene

- Roll cover dispenser at spine plate for patient's comfort and hygiene requirement

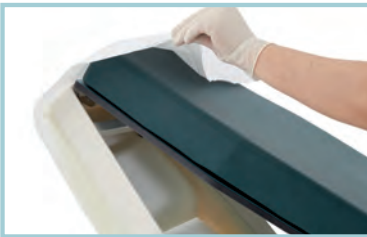

#### < Comfort

- Table extension which is integrated within the sitting plate frame and moveable by telescopic rail system in case of need



