

Mundhöhlen Instrumentarium

Oral Cavity Instruments





Über Uns

About Us

Geschichte

SPIGGLE & THEIS Medizintechnik GmbH wurde 1994 von den Geschäftsführern **David Spiggle** und **Detlef Theis** gegründet. Bis heute haben wir uns vom reinen Vertriebsunternehmen zu einem renommierten Hersteller von Medizinprodukten im Bereich der HNO-Chirurgie weiterentwickelt. Weltweit exportieren wir in über 75 Länder und in Deutschland zählen mehr als 700 Kliniken zu unseren Kunden.

Das Maß der Dinge

Im chirurgischen Instrumentenbau gilt das Siegel **“Made in Germany”** auch heute noch als Inbegriff von Qualität. Unsere chirurgischen Instrumente werden in allen Produktionsstufen unter strengsten Qualitätsanforderungen nahezu komplett in Deutschland produziert und sind somit noch größtenteils echt **“Made in Germany”**. Zur Verarbeitung wird ausschließlich Instrumentenstahl bester Güte verwendet, welcher den hohen Anforderungen moderner Chirurgie auch dauerhaft gerecht wird.

Sicherheit

Die Gesundheit der Patienten und somit die Sicherheit und Qualität unserer Produkte stehen im Mittelpunkt unseres Handelns. In diesem Sinne ist **SPIGGLE & THEIS Medizintechnik GmbH** bereits seit 1997 **ISO-zertifiziert** und unsere Produkte nach der strengen europäischen Richtlinie für Medizinprodukte CE-gekennzeichnet. Alle unsere Produkte unterliegen einer permanenten Qualitätskontrolle - von der Auswahl des Rohmaterials über die einzelnen Fertigungsschritte bis zum Versand.

Erfahrung

Unsere Mitarbeiter haben zum Teil mehr als 30 Jahre Berufserfahrung im Umgang mit chirurgischen Instrumenten. Durch dieses umfassende Know-How sowie den langjährigen und individuellen Kontakt mit den Anwendern, besitzen wir nicht nur theoretisches Wissen, sondern kennen auch deren Bedürfnisse und Ansprüche. Dies hilft uns bei der steten, praxisorientierten Weiterentwicklung unserer Produkte. Somit garantieren wir hohe Kompetenz und individuellen Service bei der Betreuung unserer Kunden.

History

SPIGGLE & THEIS Medizintechnik GmbH was founded in 1994 by the managing directors **David Spiggle** and **Detlef Theis**. The company has evolved from being purely a distributor to the established manufacturer of medical products in the area of ENT that it is today. We can count over 700 clinics amongst our German customers and export to over 75 countries world-wide.

The Seal Of Highest Quality

The stamp **“Made in Germany”** is still the epitome of quality standards in the production of surgical instruments in the world today. The majority of our surgical instruments are subjected to the strictest quality requirements at every step of their production, in the truest sense of the words, **“Made in Germany”**. Only the highest standard of instrument steel, capable of consistently meeting the demands of modern surgery, is used in the production.

Safety First

The health of our patients and therefore the safety and quality of our products plays the central role in our decisions. **SPIGGLE & THEIS Medizintechnik GmbH** has been **ISO certified**. Our products are CE-marked in accordance with the strict European guideline for medical products since 1997. All our products undergo continual quality checks, from the selection of raw materials, to the individual stages of production and finally their dispatch.

Experience

Our colleagues in instrument development can look back on over 30 years of professional practical experience with ENT-surgical instruments. We offer more than theoretical knowledge – we understand our customers needs. We enjoy close, personal contact to many of the best surgeons world-wide. This enables us to continually develop innovative products. We guarantee the highest level of competence and individual service in meeting our customers requirements.



Inhaltsverzeichnis

Table of contents

| | | |
|----|--|---------|
| 01 | Endoskopie / Endoscopy | 5 - 9 |
| 02 | Adenotomie / Adenotomy..... | 10 - 13 |
| 03 | Tonsillektomie / Tonsillectomy | 14 - 30 |
| 04 | Kehlkopf / Larynx | 31 - 35 |
| 05 | Tubeninstrumentarium / Tuba Instruments..... | 36 - 37 |
| 06 | Speichelgang / Salivary Duct..... | 38 - 39 |
| 07 | Koagulation / Coagulation | 40 - 53 |
| 08 | Tracheotomie / Weichteile / Allgemeines / Tracheotomy / Neck Dissection / Miscellaneous | 54 - 68 |
| 09 | Sets | 69 |
| | Index..... | 70 - 73 |

01 Endoskopie

Endoscopy

| | |
|------------------------|---------|
| Schaftdurchmesser | 3,4 mm |
| Shaft diameter | 3.4 mm |
| Arbeitslänge | 32 cm |
| Working length | 32 cm |
| Abwinkelung (auf / ab) | 130° |
| Angle (up / down) | 130° |
| Biegeradius | 8 mm |
| Bending radius | 8 mm |
| Blickfeld | 80° |
| Field of vision | 80° |
| Tiefenschärfe | 1-50 mm |
| Depth of focus | 1-50 mm |
| Gewicht | 230 g |
| Weight | 230 g |



| | |
|--------------|---|
| Art.-Nr./No. | |
| 30-170-28 | 2,8 mm |
| 30-170-36 | 3,4 mm |
| 30-171-40 | 4,0 mm mit Arbeitskanal / with working channel |

Die SPIGGLE & THEIS Nasopharyngoskope der neuen Generation sind intuitiv bedienbar und ergonomisch geformt. Sie wurden für die notwendige Feinfühligkeit im täglichen Routineeinsatz und für eine ermüdungsfreie Handhabung entwickelt.

Hochwertige Bildleiter und ein leistungsfähiges optisches System liefern große und helle Bilder bester Auflösung - die Voraussetzung für eine sichere Diagnose und Therapie. Dank solider Verarbeitung und konsequenter Verwendung moderner Hochleistungswerkstoffe sind SPIGGLE & THEIS Nasopharyngoskope robuster und langlebiger - trotz steigender Belastung durch moderne Aufbereitungsverfahren.

The new generation of SPIGGLE & THEIS nasopharyngoscopes impress with intuitive operability and optimal ergonomics, designed for tactile sensation and non-tiring handling as required in daily routine operations.

High-end fibre-optic bundles and a high-capacity system produce large and bright images of the best quality - necessary for safe diagnosis and treatment. Due to the consistent use and reliable processing of high-class materials, the SPIGGLE & THEIS nasopharyngoscopes are robust and durable, in spite of the increasing stress of modern cleaning and sterilizing facilities.

Vorteile unserer Endoskope:

- funktionelles Design für eine einfache und komfortable Handhabung
- feinfühlig, aber robuste Steuerung
- optimale Flexibilität und Torsionssteifigkeit des Einführungsschafts
- leistungsfähiges optisches System: größere, hellere und schärfere Bilder

Geeignete Wiederaufbereitungsverfahren:

- einlegbar in Reinigungs- und Desinfektionslösung
- STERIS
- NTDF-Sterilisation =
Niedertemperatur-Dampf-
Formaldehyd-Sterilisation
- maschinelle Aufbereitung (RDG-E)

Advantages of our endoscopes:

- functional design for easy and comfortable handling
- sensitive yet robust control
- optimal flexibility and torsional rigidity of the insertion channel
- high-performance optical system for larger, brighter and sharper images

Suitable reprocessing procedures:

- fully immersible in cleaning and disinfectant solutions
- STERIS
- LTSF-sterilization =
Low-Temperature Steam and
Formaldehyde-sterilization
- machine reprocessing (RDG-E)



01 Endoskopie

Endoscopy

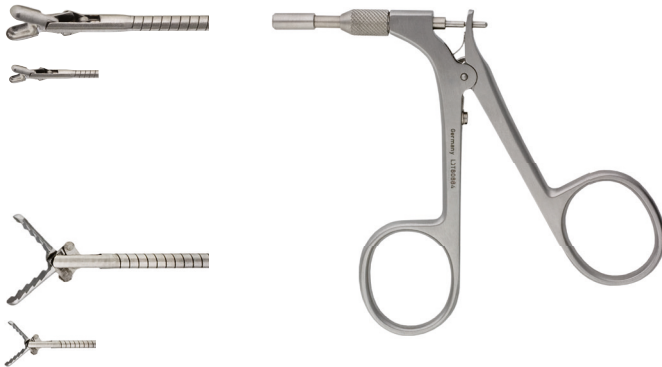

Flexible Biopsiezange, ϕ 1 mm, 1200 mm, ovaler Löffel, für flexibles Endoskop 30-171-40 / Flexible biopsy forceps, ϕ 1 mm, 1200 mm, oval cups, for flexible endoscope 30-171-40

30-172-40

Flexible Alligator-Fasszange, ϕ 1 mm, 1200 mm, gezahntes Maul, für flexibles Endoskop 30-171-40 / Flexible alligator forceps, ϕ 1 mm, 1200mm, teeth jaws, for flexible endoscope 30-171-40

30-173-40



Flexible Reinigungsbürste mit Ringgriff, einseitig, 1,2 mm, 40 cm, für flexibles Nasopharyngoskop 30-171-40 / Flexible cleaning brush with ring handle, one-sided, 1,2 mm, 40 cm, for flexible nasopharyngoscope 30-171-40

30-174-40



Ultra-Stop Antibeschlagmittel / Ultra-Stop Anti-Fog solution

| Art.-Nr./No. | Beschreibung / Description |
|--------------|--|
| 30-160-01 | 25 ml Pipettenflasche, unsteril 25 ml pipette bottle, non-sterile |
| 30-160-02 | 30 ml Durchstichflasche, steril 30 ml pierce bottle, sterile |
| 30-160-03 | 15 ml Sprayflasche, unsteril 15 ml spray bottle, non-sterile |



Endoskop-Schutzhülse, 209 mm, verlängerbar, autoklavierbar, (für ein Endoskop 40-110-xx oder 40-112-xx. Für 40-112-xx werden 2 Schutzhülsen benötigt) /

Endoscope protective sleeve, 209 mm, extendable, autoclavable, (for endoscope 40-110-xx or 40-112-xx. Two protective sleeves are needed for 40-112-xx)

30-182-21

01 Endoskopie

Endoscopy



Sterilisations-Container für Endoskope

Ø 2,5 - 5,0 mm, bis 195 mm Länge /

Sterilizing and protecting tray for endoscopes

Ø 2.5 - 5.0 mm, up to 195 mm length

| Art.-Nr./No. | Beschreibung / Description |
|--------------|---|
| 80-621-05 | für 2 Endoskope for 2 endoscopes |
| 80-622-56 | für 6 Endoskope, 1 Lichtkabel for 6 endoscopes, 1 light-cable |
| 80-623-22 | für 2 Endoskope, 1 Lichtkabel, 1 Kamerakopf for 2 endoscopes, 1 light-cable, 1 camera head |

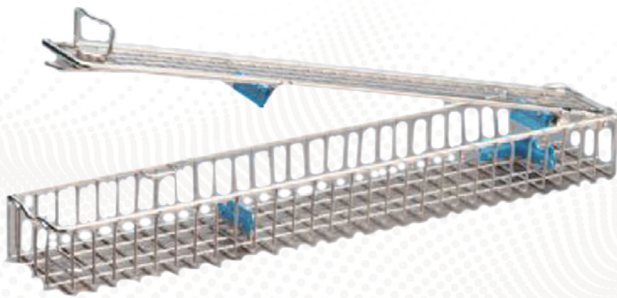

Endoskopie-Siebkorb mit Deckel, Edelstahl, epoliert /

Endoscope container with lid, stainless steel, e-polished

| Art.-Nr./No. | Größe / Size (cm) |
|--------------|--|
| 80-691-01 | 46 x 8 x 5,2 für 1 Endoskop / for 1 endoscope |
| 80-692-01 | 67 x 8 x 5,2 für 1 Endoskop / for 1 endoscope |

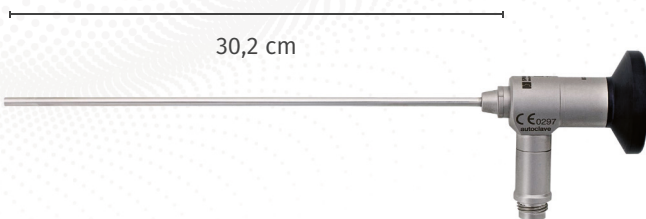

Laryngoskop, HD, autoklavierbar, 30,2 cm /

Laryngoscope, HD, autoclavable, 30.2 cm

| Art.-Nr./No. | Größe / Size (mm) | Winkel / Angle | |
|--------------|-------------------|----------------|---|
| 40-110-00 | 4,0 | 0° | ○ |
| 40-110-30 | 4,0 | 30° | ○ |
| 40-110-70 | 4,0 | 70° | ○ |
| 40-112-00 | 4,0 | 0° | ○ |
| 40-112-30 | 2,7 | 30° | ○ |
| 40-112-70 | 2,7 | 70° | ○ |



Mikro-Laryngoskop, 70°, HD, autoklavierbar /

Micro-Laryngoscope, 70°, HD, autoclavable

40-111-70





**Dr. Fog original Antibeschlagmittel mit Schwamm, steril /
Dr. Fog original anti-fog with sponge, sterile**

30-160-04



**Antifog Antibeschlag-Satz, steril, 48 Stück/Box /
Antifog-Solution Kit, sterile, 48 pieces/box**

30-160-05



LED-Leuchtgriffe / LED light handles

Art.-Nr./No. Beschreibung / Description

70-211-00 LED-Hochleistungs-Leuchtgriff, 230 V, bestehend aus: (70-211-10, 70-211-20, 70-211-30, 70-211-40)
LED high performance light-handle, 230 V, consisting of:
(70-211-10, 70-211-20, 70-211-30, 70-211-40)

70-211-01 LED-Hochleistungs-Leuchtgriff, 120 V, bestehend aus: (70-211-10, 70-211-20, 70-211-30, 70-211-50)
LED high performance light-handle, 120 V, consisting of:
(70-211-10, 70-211-20, 70-211-30, 70-211-50)

70-211-10 LED-Handgriff, schwarz, mit Helligkeitsdimmer, Ausschaltautomatik, 3 W, 5500° K, 17500 Lux, zur Verwendung mit Li-Io-Akku 3,5 V und Endoskop-Adapter, 50 Std. Brenndauer
LED light handle, black, with brightness dimmer, automatic switch-off, 3 W, 5500° K, 17500 lux, to use with Li-Io rechargeable battery 3.5 V and endoscope adapter, 50 hours run-time

70-211-20 Li-Ionen-Akku, 3,5 V, für LED-Handgriff
Li-ion rechargeable battery, 3.5 V, for LED light-handle

70-211-30 Endoskopie-Adapter für LED-Handgriff, passend für Standardgewinde an Endoskopen (AcMI-Gewinde)
Endoscope adapter for LED light-handle, fits standard endoscope threads (AcMi-thread)

70-211-40 Ladegerät für bis zu 2 LED-Handgriffe, 3,5 V, 230 V, Standgerät, Wandhalterung
Charging base for up to 2 LED light-handles, 3.5 V, 230 V, table model, with wall holder

70-211-50 Ladegerät für bis zu 2 LED-Handgriffe, 3,5 V, 120 V, Standgerät, Wandhalterung
Charging base for up to 2 LED light-handles, 3.5 V, 120 V, table model, with wall holder



01 Endoskopie

Endoscopy

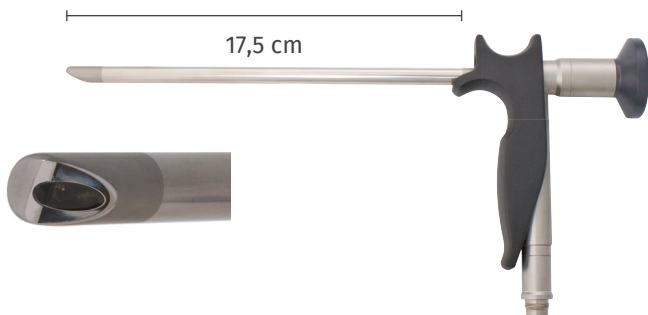

Laryngoskop, HD, autoklavierbar, 17,5 cm /
Laryngoscope, HD, autoclavable, 17.5 cm

| Art.-Nr./No. | AD / OD (mm) | Winkel / Angle | |
|--------------|--------------|----------------|-----------------------|
| 40-100-70 | 4,0 | 70° | <input type="radio"/> |
| 40-100-90 | 4,0 | 90° | <input type="radio"/> |

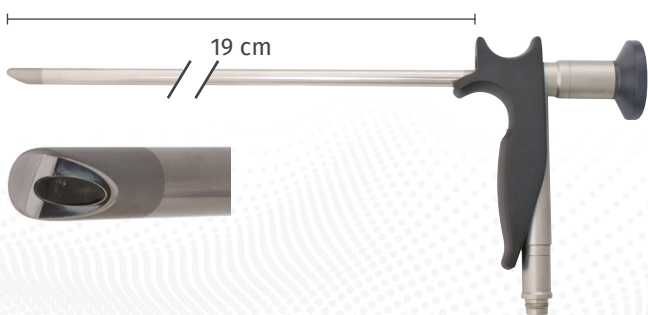

Laryngoskop, HD, autoklavierbar, Handgriff, 19 cm /
Laryngoscope, HD, autoclavable, handle, 19 cm

| Art.-Nr./No. | AD / OD (mm) | Winkel / Angle | |
|--------------|--------------|----------------|-----------------------|
| 40-103-70 | 10,0 | 70° | <input type="radio"/> |
| 40-103-90 | 10,0 | 90° | <input type="radio"/> |

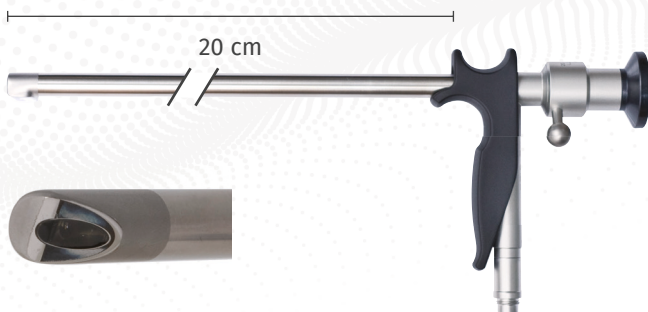

Zoom Laryngoskop, HD, einlegbar, Handgriff, 20 cm /
Zoom laryngoscope, HD, soakable, handle, 20 cm

| Art.-Nr./No. | AD / OD (mm) | Winkel / Angle | |
|--------------|--------------|----------------|-----------------------|
| 40-105-70 | 10,0 | 70° | <input type="radio"/> |
| 40-105-90 | 10,0 | 90° | <input type="radio"/> |

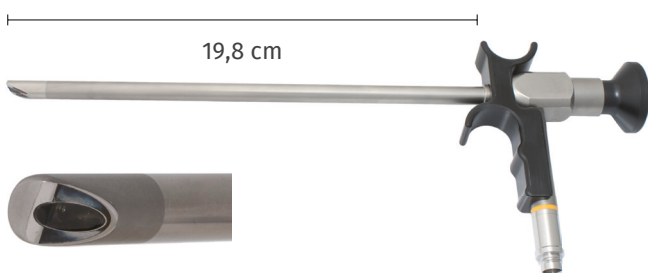

Laryngoskop, HD, autoklavierbar, 19,8 cm /
Laryngoscope, HD, autoclavable, 19.8 cm

| Art.-Nr./No. | AD / OD (mm) | Winkel / Angle | |
|--------------|--------------|----------------|-----------------------|
| 40-107-70 | 8,0 | 70° | <input type="radio"/> |



02 Adenotomie

Adenotomy

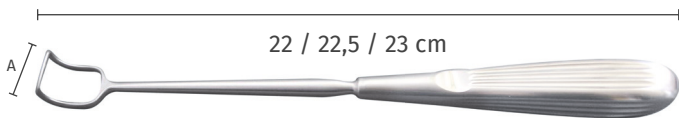

**Beckmann Ringmesser, gerade /
Beckmann adenoid curette, straight**

| Art.-Nr./ No. | Größe / Size | Länge A / Length A (mm) | Länge / Length (cm) |
|------------------|-----------------|----------------------------|------------------------|
| 40-200-00 | 0 | 10,5 | 22,0 |
| 40-200-01 | 1 | 13,0 | 22,0 |
| 40-200-02 | 2 | 14,5 | 22,0 |
| 40-200-03 | 3 | 16,5 | 22,5 |
| 40-200-04 | 4 | 18,0 | 23,0 |



**Negus Ringmesser, vorwärts gebogen, 21,5 cm /
Negus adenoid curette, curved forwards, 21.5 cm**

| Art.-Nr./ No. | Größe / Size | Länge A / Length A (mm) |
|------------------|-----------------|----------------------------|
| 40-203-00 | 0 | 11,0 |
| 40-203-01 | 1 | 13,0 |
| 40-203-02 | 2 | 15,0 |
| 40-203-03 | 3 | 17,0 |
| 40-203-04 | 4 | 18,0 |



**Stubbs Ringmesser, rückwärts gebogen, 22 cm /
Stubbs adenoid curette, curved backwards, 22 cm**

| Art.-Nr./ No. | Größe / Size | Länge A / Length A (mm) |
|------------------|-----------------|----------------------------|
| 40-206-00 | 0 | 10,0 |
| 40-206-01 | 1 | 12,0 |
| 40-206-02 | 2 | 16,0 |
| 40-206-03 | 3 | 18,0 |



**Vogel Ringmesser, gerade, 21,5 cm /
Vogel adenoid curette, straight, 21.5 cm**

| Art.-Nr./No. | Länge A / Length A (mm) |
|--------------|-------------------------|
| 40-211-07 | 7,0 |

02 Adenotomie

Adenotomy

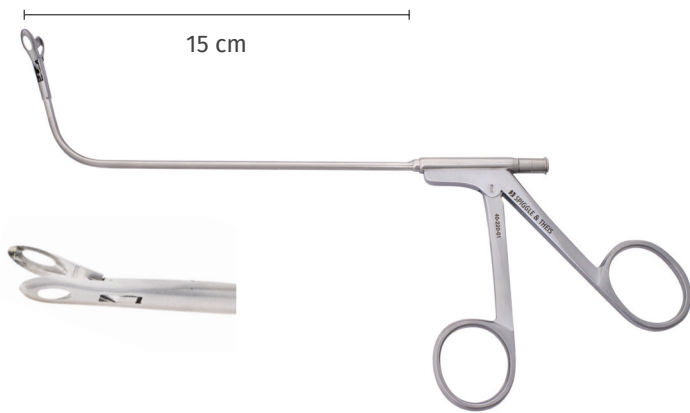

**Jatho Nasenrachenzange,
70° aufgebogen, Rohrschaft,
15 cm Arbeitslänge /
Jatho epipharyngeal forceps,
70° upcurved, tubular model,
15 cm working length**

| Art.-Nr./No. | Beschreibung / Description |
|--------------|--|
| 40-220-01 | vertikal öffnend / opens vertically |
| 40-220-02 | horizontal öffnend / opens horizontally |



**Jurasz Nasenrachenzange, 19 cm /
Jurasz adenoid forceps, 19 cm**

40-225-00



**Hartmann Conchotom, rund, 12 cm /
Hartmann cutting forceps, round, 12 cm**

| Art.-Nr./ No. | Größe / Size (mm) | |
|------------------|----------------------|--|
| 20-252-01 | 1 = 7 | |
| 20-252-02 | 2 = 8 | |
| 20-252-03 | 3 = 9 | |
| 20-252-04 | 4 = 10 | |



02 Adenotomie

Adenotomy



**Schmeden Conchotom, dreieckig, 12 cm /
Schmeden cutting forceps, triangular, 12 cm**

| Art.-Nr./ No. | Größe / Size (mm) | |
|------------------|----------------------|--|
| 20-254-00 | 0 = 6 | |
| 20-254-01 | 1 = 7 | |
| 20-254-02 | 2 = 8 | |
| 20-254-03 | 3 = 12 | |



**Nager Gaumensegelhaken, 22 cm /
Nager pillar retractor, 22 cm**

40-230-21



**Hofer Gaumenbogenhaken, 22 cm /
Hofer palate retractor, 22 cm**

40-232-23



**Haslinger Gaumensegelhalter, beweglich, 17,5 cm /
Haslinger uvula retractor, movable, 17.5 cm**

40-235-17



**Kabierske Pulverbläser,
komplett mit drei Kanülen für Ohr, Nase,
Rachen und Hals, mit Glas und Ventilball /
Kabierske powder blower,
set with three cannulae for ear, nose, pharynx
and larynx, bottle and rubber ball**

| Art.-Nr./No. | Beschreibung / Description |
|--------------|--|
| 10-155-00 | Pulverbläser komplett / powder blower, set |
| 10-155-01 | Ersatzglas / spare bottle |
| 10-155-02 | Gummiball / rubber ball |

03 Tonsillektomie

Tonsillectomy



Davis-Meyer Mundsperrer, verstellbare Zahnhaken /
Davis-Meyer mouth gag, adjustable tooth hooks

| Art.-Nr./No. | Beschreibung / Description |
|--------------|--------------------------------|
| 40-300-01 | rechts offen / right side open |
| 40-300-02 | links offen / left side open |



Davis-Boyle Mundsperrer /
Davis-Boyle mouth gag

| Art.-Nr./No. | Beschreibung / Description |
|--------------|---|
| 40-302-01 | rechts offen / right side open |
| 40-302-02 | links offen / left side open |
| 40-302-03 | rechts offen für Kinder / right side open for children |
| 40-302-04 | links offen für Kinder / left side open for children |



Silikonschützer für Davis-Boyle Mundsperrer, 1 Stück /
Silicone insert for Davis-Boyle mouth gags, 1 piece

40-303-00



Mclvor Mundsperrer, geschlossen /
Mclvor mouth gag, closed form

40-305-00



Silikonformschlauch, geschlitzt, für Mclvor
Mundsperrer, wiederverwendbar, 5 Stück /
Silicone tubing, slit, for Mclvor mouth gag,
re-useable, 5 pieces

40-305-99



Mclvor Mundsperrer, Drahtbügel mit Silikonenschutz /
Mclvor mouth gag, wire frame with silicone protection

40-305-10



03 Tonsillektomie

Tonsillectomy



Mclvor Zungenspatel, glatt /

Mclvor tongue depressor, smooth

| Art.-Nr./ No. | Größe / Size | Größe / Size (mm) |
|------------------|-----------------|----------------------|
| 40-310-01 | 1 | 23,0 x 75,0 |
| 40-310-02 | 2 | 25,0 x 91,0 |
| 40-310-03 | 3 | 26,0 x 103,0 |



Davis-Boyle Zungenspatel, mit beidseitigem Absaugrohr /

Davis-Boyle tongue depressor, double sided suction tubes

| Art.-Nr./ No. | Größe / Size | Größe / Size (mm) |
|------------------|-----------------|----------------------|
| 40-311-01 | 1 | 29,0 x 65,0 |
| 40-311-15 | 1 1/2 | 29,0 x 70,0 |
| 40-311-02 | 2 | 30,5 x 75,0 |
| 40-311-25 | 2 1/2 | 31,5 x 80,0 |
| 40-311-03 | 3 | 32,5 x 85,0 |
| 40-311-35 | 3 1/2 | 33,5 x 95,0 |
| 40-311-04 | 4 | 34,0 x 105,0 |



Davis-Boyle Zungenspatel / Davis-Boyle tongue depressor

| Art.-Nr./ No. | Größe / Size | Größe / Size (mm) | Beschreibung / Description |
|------------------|-----------------|----------------------|--|
| 40-312-01 | 1 | 20,0 x 35,0 | glatt / smooth |
| 40-312-02 | 2 | 23,0 x 70,0 | gerieft / serrated |
| 40-312-03 | 3 | 24,0 x 85,0 | gerieft / serrated |
| 40-312-04 | 4 | 25,0 x 95,0 | gerieft / serrated |
| 40-312-05 | 5 | 26,0 x 110,0 | gerieft / serrated |
| 40-313-01 | 1 | 17,0 x 35,0 | glatt für Kinder/ smooth for children |
| 40-313-02 | 2 | 19,0 x 51,0 | gerieft für Kinder/ serrated for children |
| 40-313-03 | 3 | 20,0 x 60,0 | gerieft für Kinder/ serrated for children |
| 40-313-04 | 4 | 22,0 x 75,0 | gerieft für Kinder/ serrated for children |
| 40-313-05 | 5 | 22,0 x 84,0 | gerieft für Kinder/ serrated for children |

03 Tonsillektomie

Tonsillectomy



**Russel-Davis Zungenspatel mit Rinne /
Russel-Davis tongue depressor with central channel**

| Art.-Nr./ No. | Größe / Size | Größe / Size (mm) |
|------------------|-----------------|----------------------|
| 40-315-01 | 1 | 30,0 x 70,0 |
| 40-315-02 | 2 | 34,0 x 80,0 |
| 40-315-03 | 3 | 39,0 x 85,0 |
| 40-315-04 | 4 | 42,0 x 98,0 |
| 40-315-05 | 5 | 46,0 x 107,0 |



**Russel-Davis Zungenspatel mit Rinne, schmales Modell /
Russel-Davis tongue depressor with central channel, slender model**

| Art.-Nr./ No. | Größe / Size | Größe / Size (mm) |
|------------------|-----------------|----------------------|
| 40-316-01 | 1 | 18,0 x 60,0 |
| 40-316-02 | 2 | 22,0 x 71,0 |
| 40-316-03 | 3 | 25,0 x 80,0 |

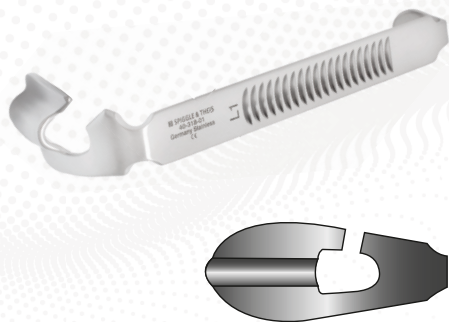

**Russel-Davis Zungenspatel mit Rinne, Ausgang links /
Russel-Davis tongue depressor with central channel, outlet left side**

| Art.-Nr./ No. | Größe / Size | Größe / Size (mm) |
|------------------|-----------------|----------------------|
| 40-318-01 | 1 | 30,0 x 70,0 |
| 40-318-02 | 2 | 34,0 x 80,0 |
| 40-318-03 | 3 | 39,0 x 85,0 |
| 40-318-04 | 4 | 42,0 x 98,0 |
| 40-318-05 | 5 | 46,0 x 107,0 |



**Zungenspatel, Würzburger Modell /
Tongue depressor, Würzburg model**

| Art.-Nr./ No. | Größe / Size | Größe / Size (mm) |
|------------------|-----------------|----------------------|
| 40-320-01 | 1 | 28,0 x 67,0 |
| 40-320-02 | 2 | 32,0 x 75,0 |
| 40-320-03 | 3 | 34,0 x 83,0 |
| 40-320-04 | 4 | 37,0 x 96,0 |
| 40-320-05 | 5 | 38,0 x 103,0 |



03 Tonsillektomie

Tonsillectomy



Ring Zungenspatel / Ring tongue depressor

| Art.-Nr./ No. | Größe / Size | Größe / Size (mm) | Beschreibung / Description |
|------------------|-----------------|----------------------|-------------------------------|
| 40-322-02 | 2 | 23,0 x 58,0 | links / left |
| 40-322-03 | 3 | 27,0 x 72,0 | links / left |
| 40-322-04 | 4 | 34,0 x 87,0 | links / left |
| 40-322-05 | 5 | 37,0 x 95,0 | links / left |
| 40-323-02 | 2 | 24,0 x 65,0 | rechts / right |
| 40-323-03 | 3 | 27,0 x 72,0 | rechts / right |
| 40-323-04 | 4 | 34,0 x 87,0 | rechts / right |
| 40-323-05 | 5 | 27,0 x 95,0 | rechts / right |



Herberhold Zungenspatel / Herberhold tongue depressor

| Art.-Nr./ No. | Größe / Size | Größe / Size (mm) |
|------------------|-----------------|----------------------|
| 40-325-01 | 1 | 29,0 x 65,0 |
| 40-325-02 | 2 | 33,0 x 73,0 |
| 40-325-03 | 3 | 38,0 x 82,0 |
| 40-325-04 | 4 | 41,0 x 97,0 |



Dingmann Mundsperrer, Rahmen mit 2 Wangenhaltern, 2 Zahnhaken und 2 Fadenführern / Dingmann mouth gag, frame with 2 cheek retractors, 2 tooth hooks and 2 thread guides

40-327-00

Dingmann Wangenhaken, verstellbar, 2 Stück / Dingmann cheek retractor, adjustable, 2 pieces

40-327-98

Dingmann Zahnhaken, verstellbar, 2 Stück / Dingmann tooth hooks, adjustable, 2 pieces

40-327-99



Dingmann Zungenspatel / Dingmann tongue depressor

| Art.-Nr./ No. | Größe / Size | Größe / Size (mm) |
|------------------|-----------------|----------------------|
| 40-327-01 | 1 | 29,0 x 65,0 |
| 40-327-02 | 2 | 29,0 x 70,0 |
| 40-327-03 | 3 | 32,0 x 82,0 |

03 Tonsillektomie

Tonsillectomy



**Negus Bruststütze, mit Halteband /
Negus chest support, with band**

| Art.-Nr./No. | Größe / Size (cm) | Beschreibung / Description |
|--------------|----------------------|--------------------------------|
| 40-330-14 | 14,0 | für Erwachsene / for adults |
| 40-330-09 | 8,5 | für Kinder / for children |

**Draffin Mundsperrer-Aufhängung /
Draffin bipod suspension for mouth gags**

| Art.-Nr./No. | Beschreibung / Description |
|--------------|-------------------------------------|
| 40-335-00 | für Erwachsene / for adults |
| 40-335-01 | für Kinder / for children |
| 40-335-99 | Magauran-Platte / Magauran plate |

40-335-99



**Narkosebügel, L-Form,
zur Aufhängung von Mundsperrern /
Anesthesia frame L-form,
for suspending mouth gags**

40-337-00

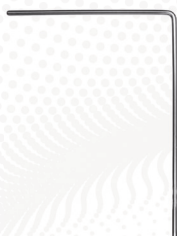

**Gelenkkloben zur Befestigung am OP-Tisch,
passend für flexiblen Spannarm 30-700-00
und Narkosebügel 40-337-00 /
Rotation clamp for fixation to operating table,
compatible with flexible holding arm 30-700-00
and anesthesia frame 40-337-00**

30-700-01



9,5 / 11,5 / 13,5 / 14,5 cm

Jennings Mundsperrer / Jennings mouth gag

| Art.-Nr./No. | Länge / Length (cm) |
|--------------|---------------------|
| 40-340-09 | 9,5 |
| 40-340-11 | 11,5 |
| 40-340-13 | 13,5 |
| 40-340-15 | 14,5 |



03 Tonsillektomie

Tonsillectomy

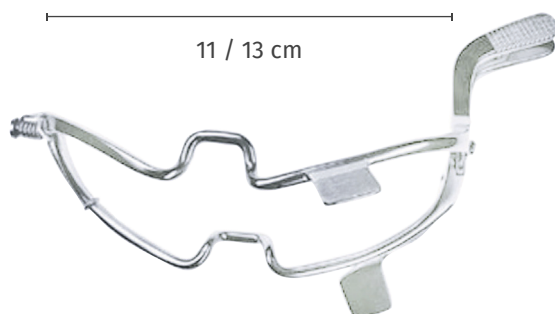

**Seemann-Seiffert Mundsperrer,
Standard-Modell, selbsttätig nachspreizend /
Seemann-Seiffert mouth gag, basic model,
self retaining**

| Art.-Nr./No. | Länge / Length (cm) |
|--------------|---------------------|
| 40-341-11 | 11,0 |
| 40-341-13 | 13,0 |

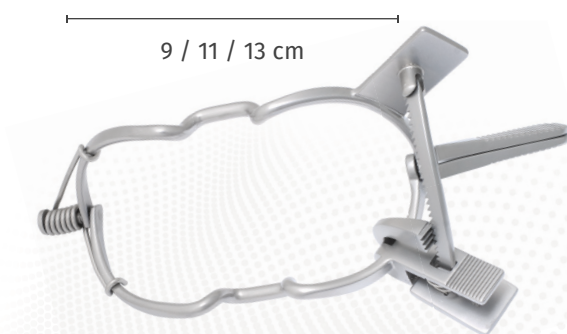

**Seemann-Seiffert Mundsperrer,
selbsttätig nachspreizend /
Seemann-Seiffert mouth gag, self retaining**

| Art.-Nr./No. | Länge / Length (cm) |
|--------------|---------------------|
| 40-342-09 | 9,0 |
| 40-342-11 | 11,0 |
| 40-342-13 | 13,0 |



**Molt Mundsperrer, 14 cm /
Molt mouth gag, 14 cm**

40-343-00



**Sluder-Ballenger Tonsillotom,
Simal-Ausführung, Handgriff /
Sluder-Ballenger tonsillotome,
simal model, handle**

40-350-10



**Sluder-Ballenger Tonsillotom Spatel,
Simal-Ausführung /
Sluder-Ballenger tonsillotome blade,
simal model**

| Art.-Nr./No. | Größe / Size |
|--------------|--------------|
| 40-350-00 | 0 |
| 40-350-01 | 1 |
| 40-350-02 | 2 |
| 40-350-03 | 3 |

03 Tonsillektomie

Tonsillectomy

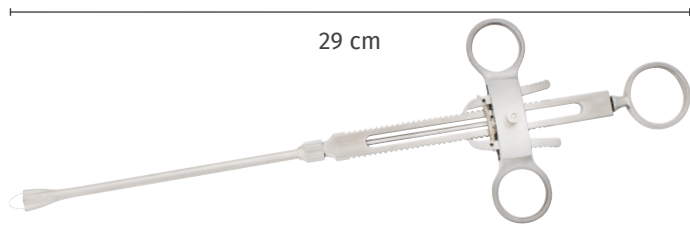

**Brünings Tonsillenschnürer, 29 cm /
Brünings tonsil snare, 29 cm**

40-355-28

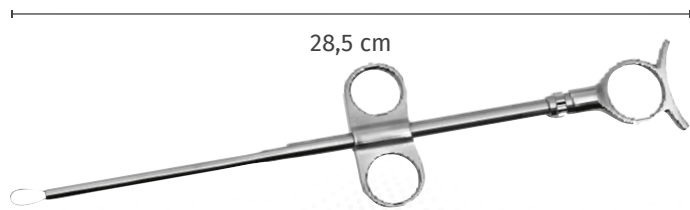

**Eves Tonsillenschnürer, 28,5 cm /
Eves tonsil snare, 28.5 cm**

40-357-28

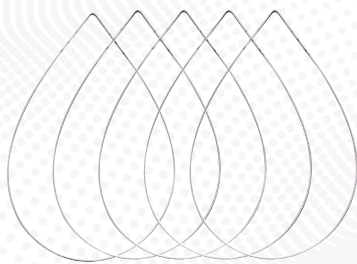

**Tonsillen-Schlingen für Brünings Tonsillen-
schnürer, Edelstahl, geschlossen, 0,4 x 50 mm,
100 Stück / Box /**

**Tonsil wire loops for Brünings tonsil snare,
stainless steel, closed, 0.4 x 50 mm,
100 pieces / box**

40-360-50

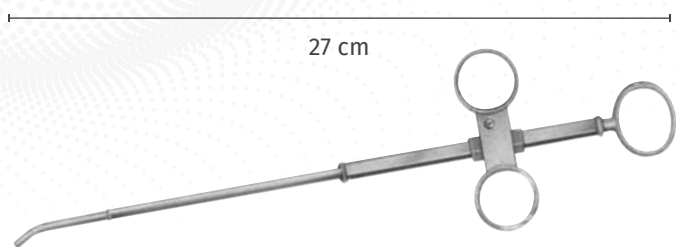

**Roeder Ligatur-Instrument,
Form E, für Vicryl-Faden, 27 cm /
Roeder ligature instrument,
form E, for vicryl wire, 27 cm**

40-359-27



**Drahtbiede- und Schneideschere,
Hartmetall, gezahnt, gewinkelt, 12 cm /
Wire bending and cutting scissors,
tungsten carbide, with teeth, angled, 12 cm**

10-745-12



03 Tonsillektomie

Tonsillectomy

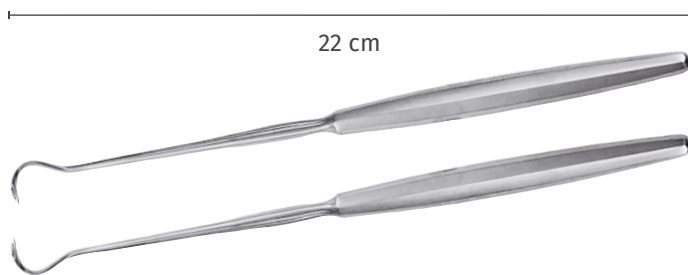

Hurd Unterbindungsnadel, 22 cm /
Hurd tonsil suture needle, 22 cm

| Art.-Nr./No. | Beschreibung / Description |
|--------------|-------------------------------|
| 40-365-01 | rechts gebogen / right curved |
| 40-365-02 | links gebogen / left curved |

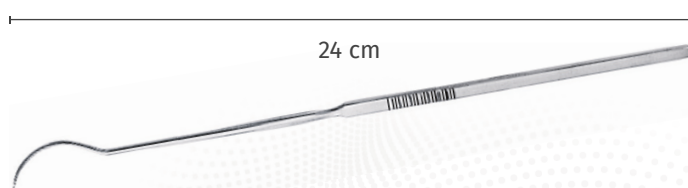

Nager Unterbindungsnadel, gerade, 23,5 cm /
Nager tonsil suture needle, straight, 23.5 cm

40-367-24



Fadenhäkchen, spitz, rund, 90°, 20 cm /
Suture hook, pointed, round, 90°, 20 cm

40-368-21



Fadenhäkchen, stumpf, flach, 90°, 20 cm /
Suture hook, blunt, flat, 90°, 20 cm

40-369-21



Knotenführer, gabelförmig, stumpf, 20,5 cm /
Knot tier, forked, blunt, 20.5 cm

40-370-21



Henke Raspatorium,
doppelseitig, schmal/breit, 24 cm /
Henke raspatory,
double ended, slender/wide, 24 cm

40-382-24

03 Tonsillektomie

Tonsillectomy



**Henke Raspatorium / Dissektor /
Henke raspatory / dissector**

| Art.-Nr./ No. | Größe / Size (mm) | Länge / Length (cm) | Beschreibung / Description |
|------------------|----------------------|------------------------|-------------------------------|
| 40-381-12 | 12,0 | 23,5 | schmal / slender |
| 40-381-15 | 15,0 | 24,0 | breit / wide |



**Stierlen Saugraspatorium, 13 mm, 23,5 cm /
Stierlen suction raspatory, 13 mm, 23.5 cm**

40-384-24



**Hurd Raspatorium/Retraktor, 10 mm/15 mm, 23 cm /
Hurd dissector/retractor, 10 mm/15 mm, 23 cm**

40-385-23



**Hurd Elevatorium/Retraktor, gefenstert, 11,5 mm, 23 cm /
Hurd elevator/retractor, fenestrated, 11.5 mm, 23 cm**

40-386-23

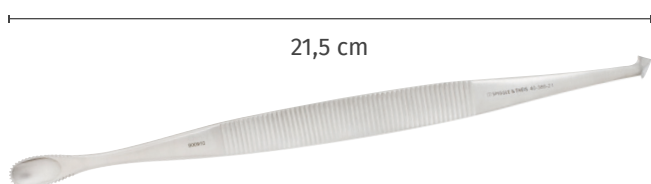

**Raspatorium Würzburger Modell,
eine Seite gezahnt, eine Seite Lanzett, 10 mm, 21,5 cm /
Raspatory Würzburg type,
one side serrated, one side lancet, 10 mm, 21.5 cm**

40-388-21



03 Tonsillektomie

Tonsillectomy

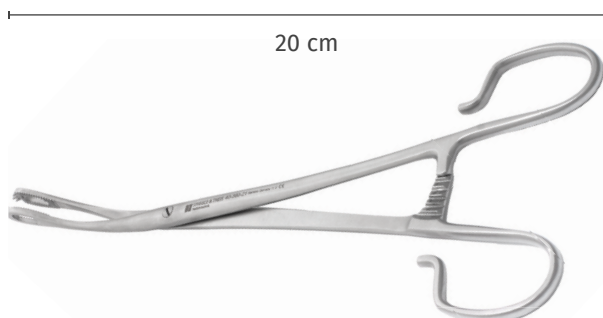

**Blohmke Fasszange,
gebogen, 20 cm /
Blohmke tonsil forceps,
curved, 20 cm**

40-390-21

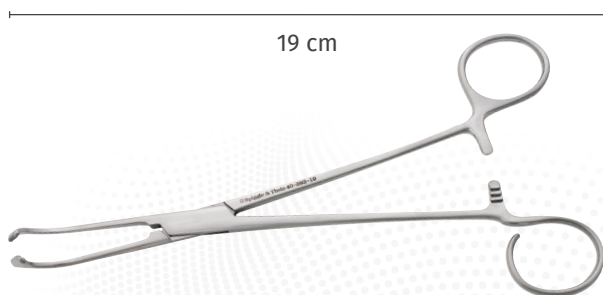

**Colver Fasszange,
gebogen, 19 cm /
Colver tonsil forceps,
curved, 19 cm**

40-392-19

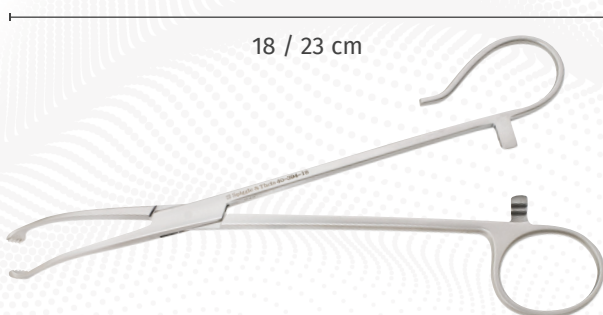

**White Fasszange, gebogen /
White tonsil forceps, curved**

| Art.-Nr./No. | Länge / Length (cm) |
|--------------|---------------------|
| 40-394-18 | 18,0 |
| 40-394-23 | 23,0 |

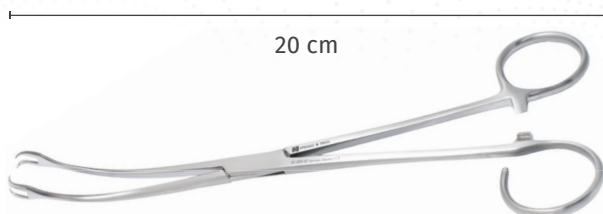

**Ballenger Fasszange,
gebogen, 2:2 Zähne, 20 cm /
Ballenger tonsil forceps,
curved, 2:2 teeth, 20 cm**

40-395-22

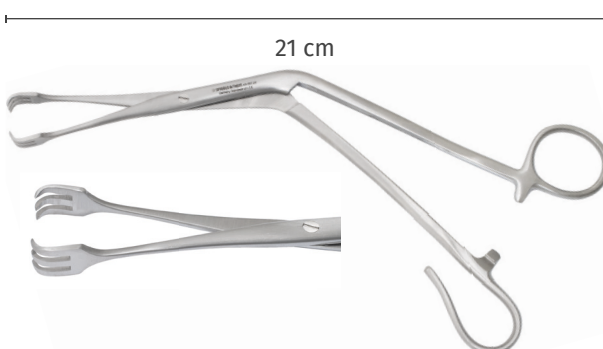

**Tyding Fasszange,
kniegebogen, 3:3 Zähne, 21 cm /
Tyding tonsil forceps,
angled, 3:3 teeth, 21 cm**

40-397-21

03 Tonsillektomie

Tonsillectomy

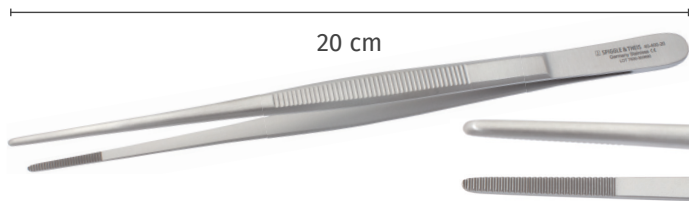

**Tonsillen-Pinzette,
gerieft, fein, 2,2 mm, 20 cm /
Tonsil dressing forceps,
serrated, fine, 2.2 mm, 20 cm**

40-400-20

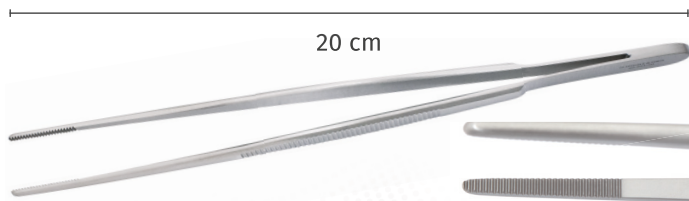

**Tonsillen-Pinzette,
gerieft, breit, 3,5 mm, 20 cm /
Tonsil dressing forceps,
serrated, wide, 3.5 mm, 20 cm**

40-401-20

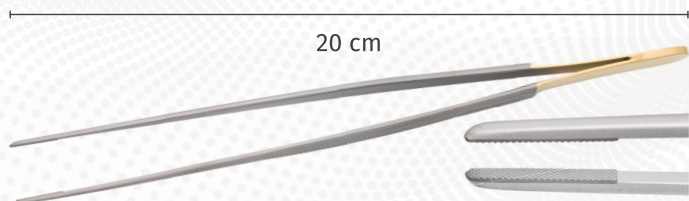

**Tonsillen-Pinzette,
gerieft, Hartmetall, 2 mm, 20 cm /
Tonsil dressing forceps,
serrated, tungsten carbide, 2 mm, 20 cm**

40-402-20

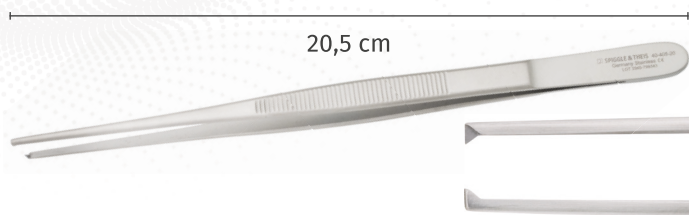

**Tonsillen-Pinzette,
1:2 Zähne, fein, 2 mm, 20,5 cm /
Tonsil dissecting forceps,
1:2 teeth, fine, 2 mm, 20.5 cm**

40-405-20

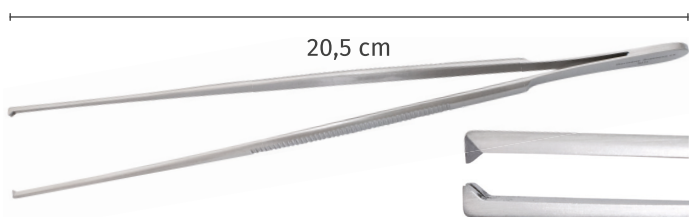

**Tonsillen-Pinzette, breit, 20,5 cm /
Tonsil dissecting forceps, wide, 20.5 cm**

| Art.-Nr./ No. | Größe / Size (mm) | Zähne / Teeth |
|------------------|----------------------|------------------|
| 40-406-20 | 2,5 | 1:2 |
| 40-407-20 | 3,5 | 2:3 |
| 40-408-20 | 4,5 | 3:4 |



03 Tonsillektomie

Tonsillectomy

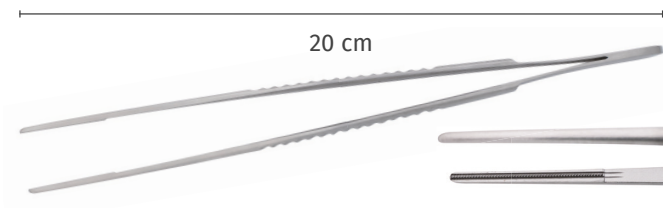

**DeBaKey Pinzette, atraumatisch, 20 cm /
DeBaKey dressing forceps, atraumatic, 20 cm**

| Art.-Nr./ No. | Größe / Size (mm) |
|------------------|----------------------|
| 40-410-20 | 2,7 |
| 40-412-20 | 2,0 |



**Yankauer Saugrohr, abschraubbarer Ansatz /
Yankauer Suction tube, detachable tip**

| Art.-Nr./No. | Länge / Length (cm) | Öffnung / Opening (mm) | ∅ |
|---|------------------------|---------------------------|-----|
| 40-420-29 für Erwachsene / for adults | 28,5 | 3,0 | 6,0 |
| 40-421-21 Für Kinder / for children | 21,5 | 2,0 | 5,0 |



**Abschraubbarer Ansatz, Ersatzteil für 40-420-29 /
Detachable attachment, spare part for 40-420-29**

40-420-99



**Saugrohr, gerade, biegsam, konisch, 3,0 mm, 19,5 cm /
Suction tube, straight, bendable, conical, 3.0 mm, 19.5 cm**

10-303-18



**Good-Schweckendiek Tonsillenschere,
gebogen, gezahnt, 19 cm /
Good-Schweckendiek tonsil scissors,
curved, serrated, 19 cm**

40-430-19

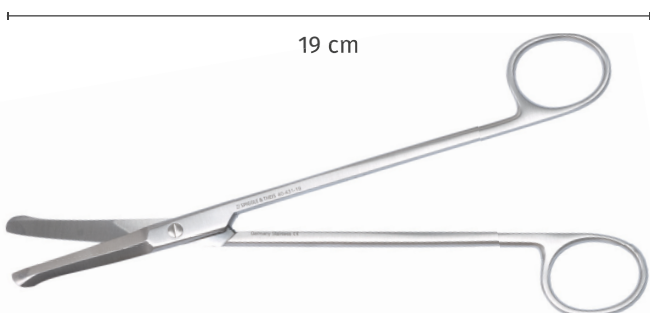

**Good Tonsillenschere, gebogen, glatt, 19 cm /
Good tonsil scissors, curved, smooth, 19 cm**

40-431-19

03 Tonsillektomie

Tonsillectomy



**Boettcher Tonsillenschere, gebogen, 18,5 cm /
Boettcher tonsil scissors, curved, 18.5 cm**

| Art.-Nr./No. | Beschreibung / Description |
|--------------|----------------------------|
| 40-433-18 | stumpf / blunt |
| 40-434-18 | spitz / pointed |



**Dean Tonsillenschere,
doppelt gebogen, gezahnt, spitz, 17,5 cm /
Dean tonsil scissors,
double curved, serrated, pointed, 17.5 cm**

40-436-17



**Muck Tonsillenschere, stark gebogen, 18,5 cm /
Muck tonsil scissors, strongly curved, 18.5 cm**

40-438-18

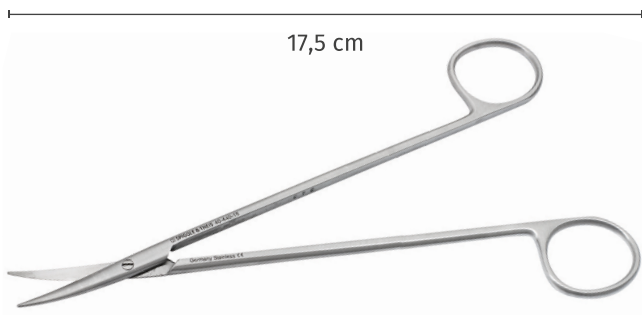

**Toennis-Adson Tonsillenschere,
gebogen, stumpf, extra fein, 17,5 cm /
Toennis-Adson tonsil scissors,
curved, blunt, very fine, 17.5 cm**

40-440-18



03 Tonsillektomie

Tonsillectomy



Toennis-Adson Tonsillenschere,
supercut, gebogen, stumpf, extra fein, 17,5 cm /
Toennis-Adson tonsil scissors,
supercut, curved, blunt, very fine, 17.5 cm

40-441-18



Toennis-Adson Tonsillenschere,
Hartmetall, supercut, gebogen, stumpf, extra fein, 17,5 cm /
Toennis-Adson tonsil scissors,
tungsten carbide, supercut, curved, blunt, very fine, 17.5 cm

40-442-18

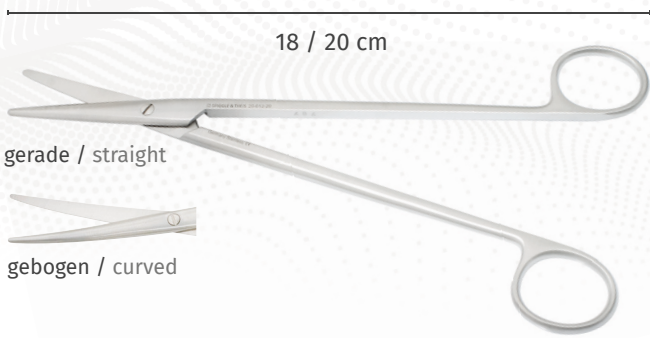

Metzenbaum Schere, stumpf-stumpf /
Metzenbaum scissors, blunt

| Art.-Nr./No. | Länge / Length (cm) | Beschreibung / Description |
|--------------|------------------------|-------------------------------|
| 20-612-18 | 18,0 | gerade / straight |
| 20-612-20 | 20,0 | gerade / straight |
| 20-614-18 | 18,0 | fein, gebogen / fine, curved |
| 20-614-20 | 20,0 | fein, gebogen / fine, curved |

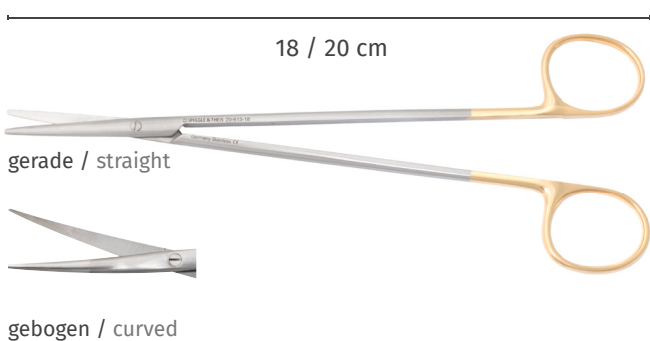

Metzenbaum Schere, Hartmetall, stumpf-stumpf, fein /
Metzenbaum scissors, tungsten Carbide, blunt, fine

| Art.-Nr./No. | Länge / Length (cm) | Beschreibung / Description |
|--------------|------------------------|-------------------------------|
| 20-613-18 | 18,0 | gerade / straight |
| 20-613-20 | 20,0 | gerade / straight |
| 20-615-18 | 18,0 | gebogen / curved |
| 20-615-20 | 20,0 | gebogen / curved |

03 Tonsillektomie

Tonsillectomy

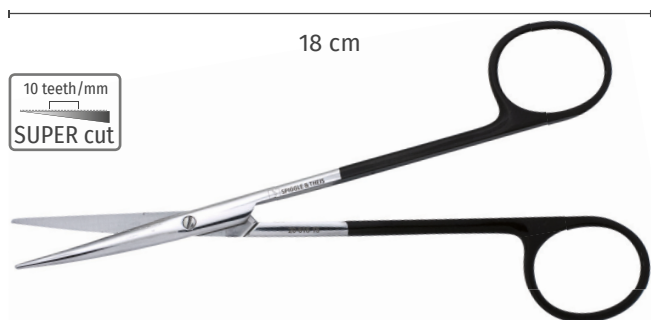

Metzenbaum Schere,
supercut, gebogen, stumpf-stumpf, fein, 18 cm /
Metzenbaum scissors,
supercut, curved, blunt, fine, 18 cm

20-616-18

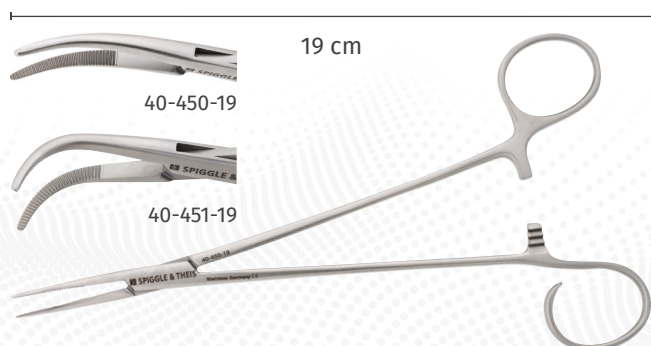

Schnidt Tonsillenklemme, einseitig offener Ring, schlank, 19 cm /
Schnidt tonsil forceps, one ring open, slender, 19 cm

| Art.-Nr./No. | Beschreibung / Description |
|--------------|----------------------------------|
| 40-450-19 | leicht gebogen / slightly curved |
| 40-451-19 | stark gebogen / strongly curved |

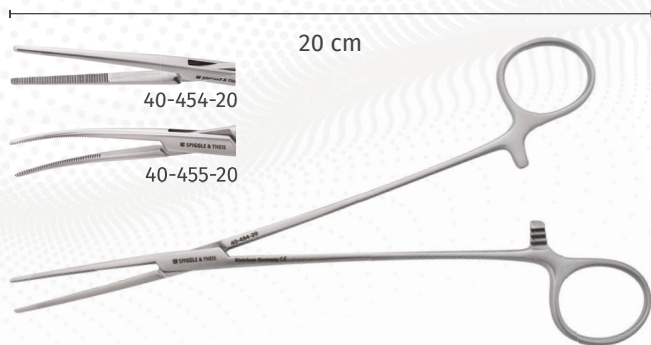

Birkett Tonsillenklemme, schlank, 20 cm /
Birkett tonsil forceps, slender, 20 cm

| Art.-Nr./No. | Beschreibung / Description |
|--------------|----------------------------|
| 40-454-20 | gerade / straight |
| 40-455-20 | gebogen / curved |

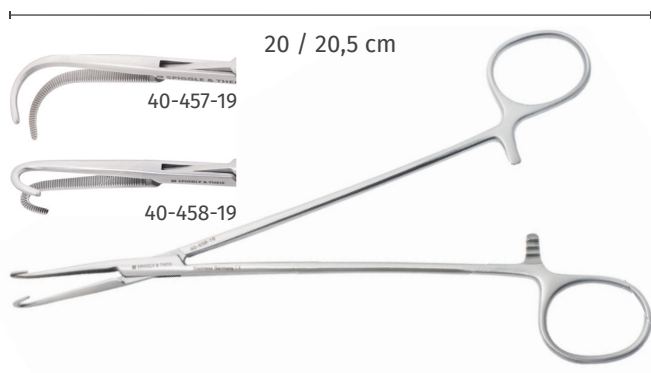

Negus Tonsillenklemme, schlank /
Negus tonsil forceps, slender

| Art.-Nr./No. | Länge / Length (cm) | Beschreibung / Description |
|--------------|---------------------|-----------------------------|
| 40-457-19 | 20,0 | stark gebogen / wide curved |
| 40-458-19 | 20,5 | enger Bogen / narrow curve |



03 Tonsillektomie

Tonsillectomy

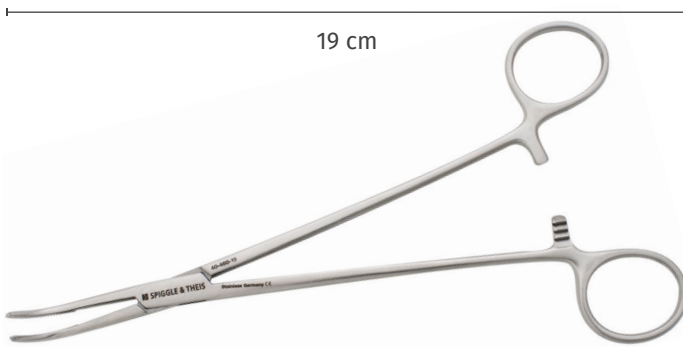

Overholt-Geissdoerfer Tonsillenklemme, gebogen, 19 cm /

Overholt-Geissdoerfer tonsil forceps, curved, 19 cm

40-460-19

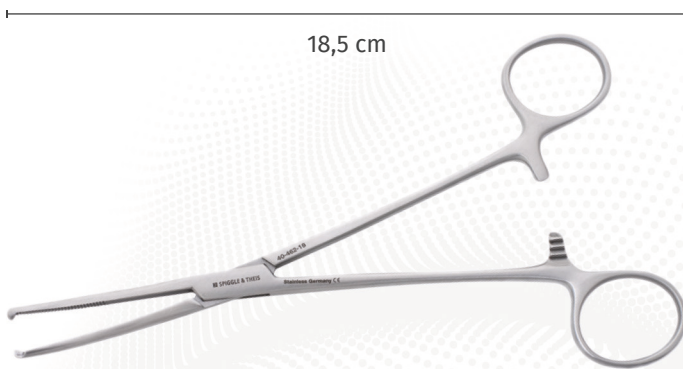

Mikulicz Tonsillenklemme, gebogen, 1:2 Zähne, 18,5 cm /

Mikulicz tonsil forceps, curved, 1:2 teeth, 18.5 cm

40-462-18

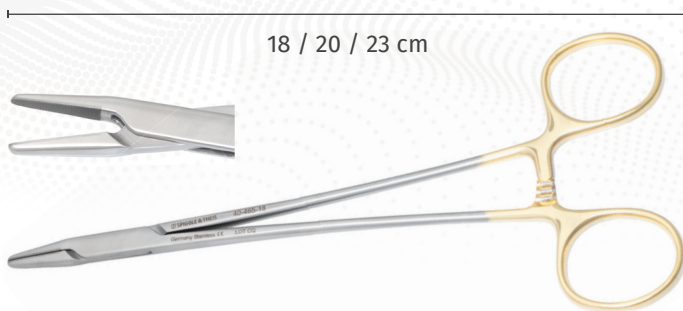

Crile-Wood Nadelhalter, Hartmetall, schlank / Crile-Wood needle holder, tungsten carbide, slender

| Art.-Nr./No. | Länge / Length (cm) |
|--------------|---------------------|
| 40-465-18 | 18,0 |
| 40-465-20 | 20,0 |
| 40-465-23 | 23,0 |

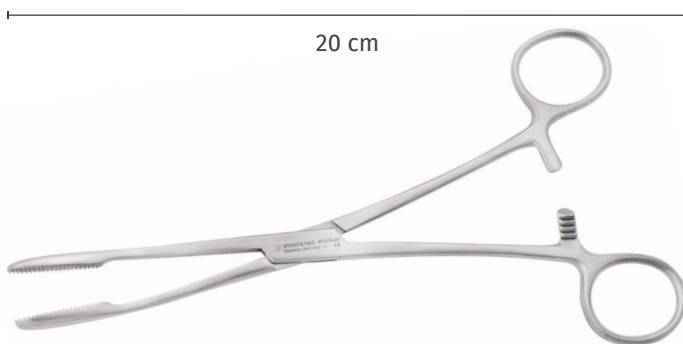

Gross Kornzange, gebogen, 20 cm / Gross sponge forceps, curved, 20 cm

40-474-20

03 Tonsillektomie

Tonsillectomy



**Gross-Maier Kornzange, gebogen, 26 cm /
Gross-Maier sponge forceps, curved, 26 cm**

40-475-26

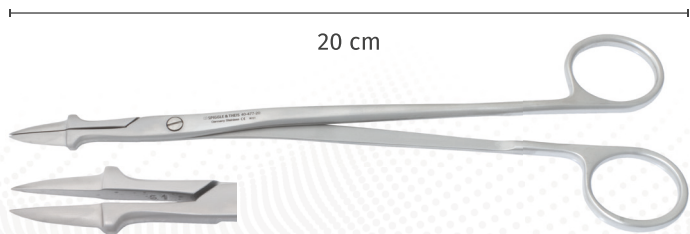

**Thilenius Tonsillen-Abszess-Zange,
gebogen, 20 cm /
Thilenius tonsil abscess forceps,
curved, 20 cm**

40-477-20



**Abraham Tonsillennmesser, spitz, gebogen, 22 cm /
Abraham tonsil knife, pointed, curved, 22 cm**

40-480-22



**Brünings Tonsillennmesser, spitz, gebogen, 23 cm /
Brünings tonsil knife, pointed, curved, 23 cm**

40-482-23



**Colver-Fischer Tonsillennmesser,
gewinkelt, gezahnt, 22 cm /
Colver-Fischer tonsil knife,
angled, serrated, 22 cm**

40-484-22



03 Tonsillektomie

Tonsillectomy



Skalpelle-Griff / Scalpel handle

| Art.-Nr./No. | Nr. / No. | Länge / Length (cm) |
|--------------|-----------|---------------------|
| 10-360-03 | 3 | 12,0 |
| 10-360-04 | 4 | 13,0 |
| 10-360-07 | 7 | 16,0 |
| 10-360-33 | 3L | 21,0 |



Skalpelle-Klingen, einzeln steril verpackt, 100 Stück / Scalpel blades, single sterile packed, 100 pieces

| Art.-Nr./No. | Nr. / No. | Beschreibung / Description |
|--------------|-----------|----------------------------|
| 10-360-10 | 10 | |
| 10-360-11 | 11 | spitz / pointed |
| 10-360-15 | 15 | gerundet / rounded |

04 Kehlkopf

Larynx



**Brünings Zungenspatel, gefenstert, 19 cm /
Brünings tongue depressor, fenestrated, 19 cm**

40-500-19



**Frenzel Zungenspatel, 16,5 cm /
Frenzel tongue depressor, 16.5 cm**

40-502-17



**Buchwald Zungenspatel, 19/23 mm, 18 cm /
Buchwald tongue depressor, 19/23 mm, 18 cm**

40-508-18



**Moritz-Schmidt Zungenspatel,
gefenstert, 19,5 cm /
Moritz-Schmidt tongue depressor,
fenestrated, 19.5 cm**

40-506-19

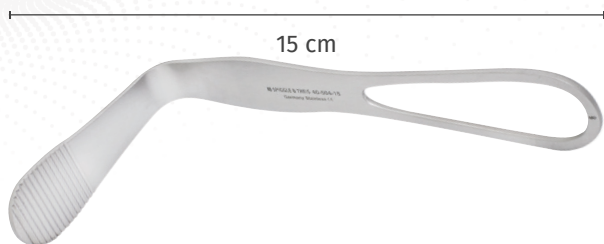

**Hartmann Zungenspatel, gewinkelt, 15 cm /
Hartmann tongue depressor, angled, 15 cm**

40-504-15

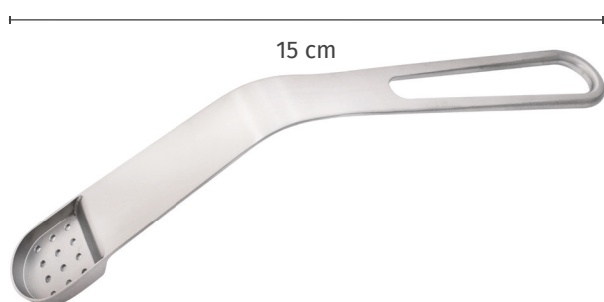

**Tapia Adenoid Spatel, 15 cm /
Tapia adenoid spatula, 15 cm**

| Art.-Nr./No. | Löcher / Holes |
|--------------|----------------|
| 40-510-01 | 9 |
| 40-510-02 | 12 |
| 40-510-03 | 15 |



04 Kehlkopf

Larynx



Kehlkopfspiegel ohne Griff, ohne Gewinde / Laryngeal mirror without handle, without screw

| Art.-Nr./No. | Größe / Size | ø (mm) |
|--------------|--------------|--------|
| 40-522-30 | 000 | 6,0 |
| 40-522-20 | 00 | 8,0 |
| 40-522-00 | 0 | 10,0 |
| 40-522-01 | 1 | 12,0 |
| 40-522-02 | 2 | 14,0 |
| 40-522-03 | 3 | 16,0 |
| 40-522-04 | 4 | 18,0 |
| 40-522-05 | 5 | 20,0 |
| 40-522-06 | 6 | 22,0 |
| 40-522-07 | 7 | 24,0 |
| 40-522-08 | 8 | 26,0 |
| 40-522-09 | 9 | 28,0 |
| 40-522-10 | 10 | 30,0 |



Kehlkopfspiegel, Rhodium beschichtet, ohne Griff, ohne Gewinde / Laryngeal mirror, rhodium coated, without handle, without screw

| Art.-Nr./No. | Größe / Size | ø (mm) |
|--------------|--------------|--------|
| 40-524-30 | 000 | 6,5 |
| 40-524-20 | 00 | 8,5 |
| 40-524-00 | 0 | 10,5 |
| 40-524-01 | 1 | 12,5 |
| 40-524-02 | 2 | 14,5 |
| 40-524-03 | 3 | 16,0 |
| 40-524-04 | 4 | 18,5 |
| 40-524-05 | 5 | 20,0 |
| 40-524-06 | 6 | 22,0 |
| 40-524-07 | 7 | 24,0 |
| 40-524-08 | 8 | 26,0 |
| 40-524-09 | 9 | 28,0 |
| 40-524-10 | 10 | 30,5 |

04 Kehlkopf

Larynx



**Kehlkopfspiegel, Rhodium beschichtet, fester Sechskantgriff /
Laryngeal mirror, rhodium plated, fixed hexagonal handle**

| Art.-Nr./No. | Größe / Size | ø (mm) |
|--------------|--------------|--------|
| 40-525-30 | 000 | 6,0 |
| 40-525-20 | 00 | 8,0 |
| 40-525-00 | 0 | 10,0 |
| 40-525-01 | 1 | 12,0 |
| 40-525-02 | 2 | 14,0 |
| 40-525-03 | 3 | 16,0 |
| 40-525-04 | 4 | 18,0 |
| 40-525-05 | 5 | 20,0 |
| 40-525-06 | 6 | 22,0 |
| 40-525-07 | 7 | 24,0 |
| 40-525-08 | 8 | 26,0 |
| 40-525-09 | 9 | 28,0 |
| 40-525-10 | 10 | 30,0 |



**Griff für Kehlkopfspiegel, Zentralverschraubung, 11 cm /
Handle for laryngeal mirrors, central screw, 11 cm**

40-520-00

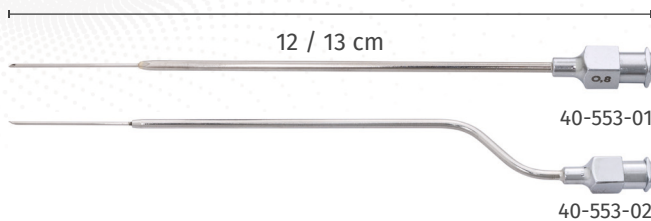

**Injektionskanüle, 0,8 mm, Luer-Lock /
Injection needle, 0.8 mm, Luer-Lock**

| Art.-Nr./No. | Länge / Length (cm) | Beschreibung / Description |
|--------------|---------------------|----------------------------|
| 40-553-01 | 12,0 | gerade / straight |
| 40-553-02 | 13,0 | bajonett / bayonet |

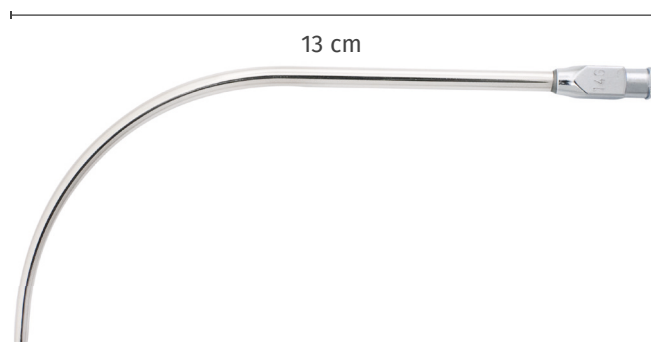

**Kehlkopf-Kanüle, gebogen, Luer-Lock, 2,0 mm, 13 cm /
Laryngeal cannula, curved, Luer-Lock, 2.0 mm, 13 cm**

40-555-13



04 Kehlkopf

Larynx



**Reichert Epiglottis Halter, gebogen, 23,5 cm /
Reichert epiglottis holder, curved, 23.5 cm**

40-558-24

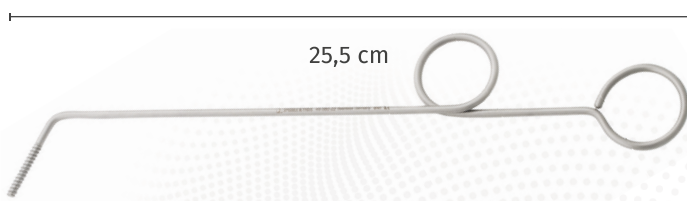

**Pelteson Kehlkopfwatteträger,
gewinkelt, 2-Ring, 25,5 cm /
Pelteson laryngeal cotton carrier,
angled, 2 rings, 25.5 cm**

40-560-22

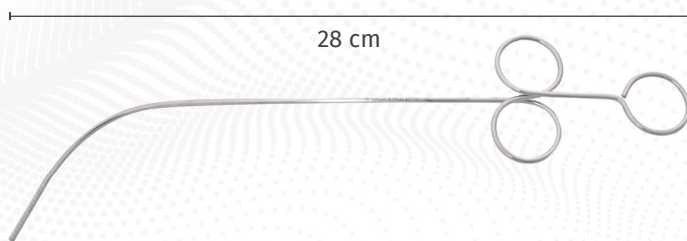

**Kehlkopfwatteträger, fein
gebogen, 3-Ring, 28 cm /
Laryngeal cotton carrier, fine,
curved, 3 rings, 28 cm**

40-561-28

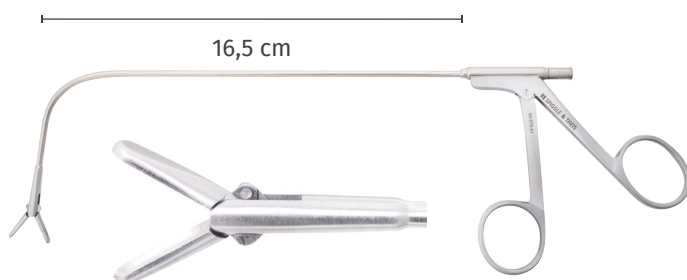

**Kehlkopfzange,
Rohrschaft, gebogen, ovale Löffel,
Spülkanal, Arbeitslänge 16,5 cm /
Laryngeal forceps,
tubular model, curved, oval cups,
irrigation channel, working length 16.5 cm**

| Art.-Nr./No. | Beschreibung / Description |
|--------------|----------------------------|
| 40-570-01 | vertikal / vertical |
| 40-570-02 | horizontal / horizontal |

04 Kehlkopf

Larynx

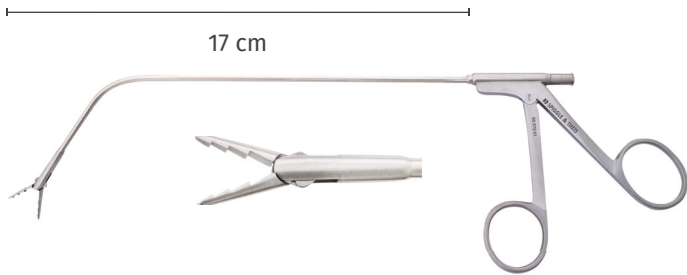

**Kehlkopffzange,
Rohrschaft, gebogen, Hechtmaul,
Spülkanal, Arbeitslänge 17 cm /
Laryngeal forceps,
tubular model, curved, alligator,
irrigation channel, working length 17 cm**

| Art.-Nr./No. | Beschreibung / Description |
|--------------|----------------------------|
| 40-572-01 | vertikal / vertical |
| 40-572-02 | horizontal / horizontal |



**Huber Universal Handgriff, Standard /
Huber universal handle, standard**

40-575-00

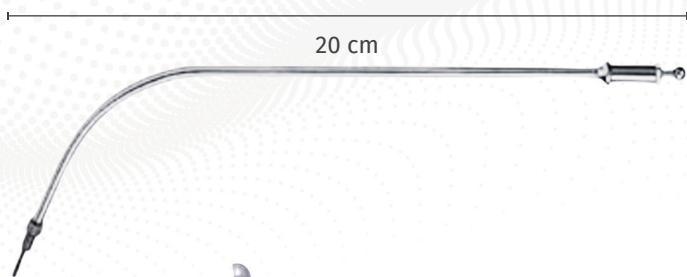

**Ansatzrohr, gebogen, 20 cm /
Connecting tube, curved, 20 cm**

40-576-20



**Brünings Löffelansatz, rund, 3 mm /
Brünings tip, round cups, 3 mm**

| Art.-Nr./No. | Beschreibung / Description |
|--------------|---------------------------------------|
| 40-578-00 | gerade / straight |
| 40-579-00 | nach oben gebogen / curved upwards |

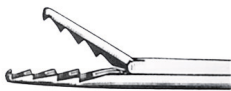

**Seiffert Hechtmaulansatz, gerade /
Seiffert alligator tip, straight**

40-580-00



**Fraenkel Löffelansatz, oval, gerade, 10 x 4,5 mm /
Fraenkel tip, oval cups, straight, 10 x 4.5 mm**

40-581-00



05 Tubeninstrumentarium

Instruments for the tuba Eustachii

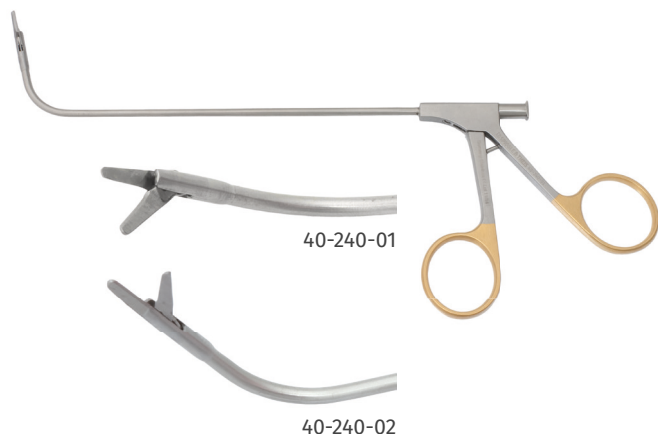

**TubalInstruments Schere,
85° aufgebogen, Griff vergoldet, 15 cm /
TubalInstruments scissors,
85° curved, gold plated grip, 15 cm**

| Art.-Nr./No. | Beschreibung / Description |
|--------------|----------------------------|
| 40-240-01 | horizontal / horizontal |
| 40-240-02 | vertikal / vertical |

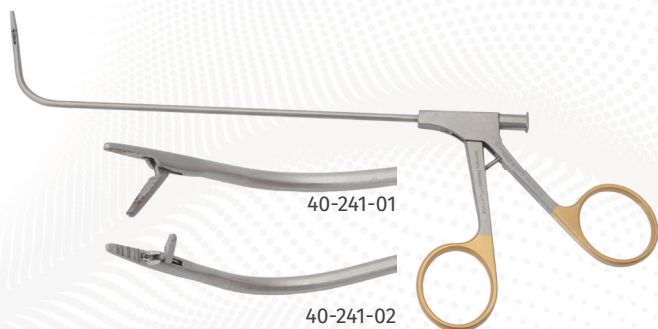

**TubalInstruments Fasszange,
85° aufgebogen, Griff vergoldet, 15 cm /
TubalInstruments forceps,
85° curved, gold plated grip, 15 cm**

| Art.-Nr./No. | Beschreibung / Description |
|--------------|----------------------------|
| 40-241-01 | horizontal / horizontal |
| 40-241-02 | vertikal / vertical |

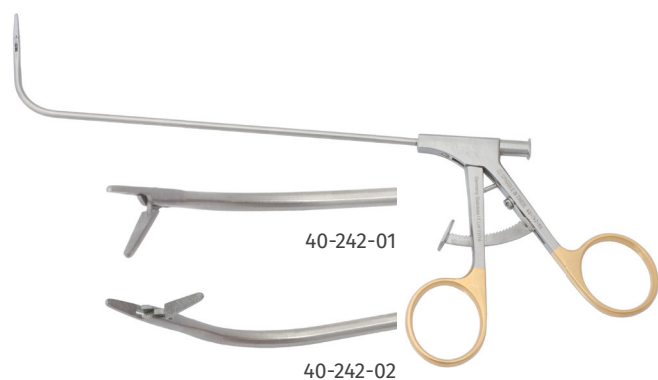

**TubalInstruments Nadelhalter,
85° aufgebogen, gerieft, Griff vergoldet, 15 cm /
TubalInstruments needle holder,
85° curved, serrated, gold plated grip, 15 cm**

| Art.-Nr./No. | Beschreibung / Description |
|--------------|----------------------------|
| 40-242-01 | horizontal / horizontal |
| 40-242-02 | vertikal / vertical |

05 Tubeninstrumentarium

Instruments for the tuba Eustachii



Tubalstruments Sauger,
85° aufgebogen, Olive, 17 cm /
Tubalstruments suction tube,
85° curved, rounded tip, 17 cm

40-243-00

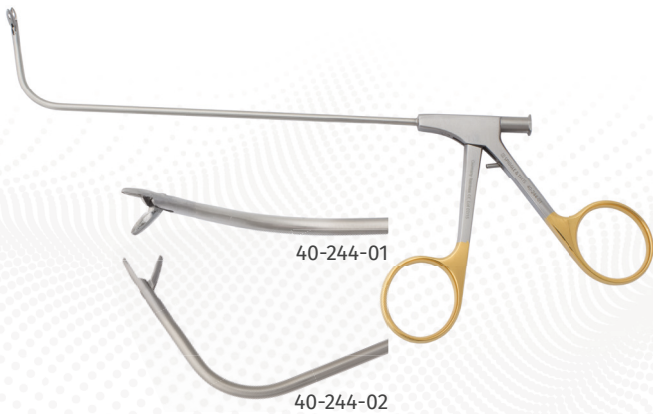

Tubalstruments Blakesley,
85° aufgebogen, 2,5 mm, Griff vergoldet, 15 cm /
Tubalstruments Blakesley,
85° curved, 2.5 mm, gold plated grip, 15 cm

| Art.-Nr./No. | Beschreibung / Description |
|--------------|----------------------------|
| 40-244-01 | horizontal / horizontal |
| 40-244-02 | vertikal / vertical |



Tubalstruments Löffelzange,
85° aufwärts gebogen, 2,5 mm, Griff vergoldet,
15 cm /
Tubalstruments, oval cups,
85° upwards curved, 2.5 mm, gold plated grip,
15 cm

| Art.-Nr./No. | Beschreibung / Description |
|--------------|----------------------------|
| 40-245-01 | horizontal / horizontal |
| 40-245-02 | vertikal / vertical |



06 Speichelgang

Salivary Duct



**Speichelgang-Schere, gewinkelt, 11,5 cm /
Salivary duct scissors, angled, 11.5 cm**

| Art.-Nr./No. | Beschreibung / Description |
|--------------|-------------------------------|
| 40-600-12 | mit Knopf / with ball end |
| 40-601-12 | ohne Knopf / without ball end |

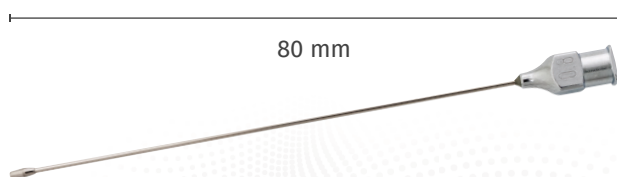

**Knopfkanüle, gerade, Luer-Lock, unsteril /
Cannula ball-ended, straight, Luer-lock, non-sterile**

| Art.-Nr./No. | Größe / Size (mm) |
|--------------|-------------------|
| 40-604-08 | 0,8 x 80 |
| 40-604-10 | 1,0 x 80 |
| 40-604-12 | 1,2 x 80 |

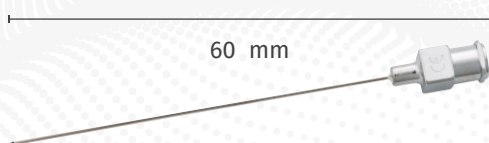

**Bangerter Tränenwegkanüle, unsteril
stumpf, seitliche Öffnung, gerade, Luer-Lock /
Bangerter lacrimal duct cannula, non-sterile
blunt, lateral opening, straight, Luer-lock**

| Art.-Nr./No. | Größe / Size (mm) |
|--------------|-------------------|
| 40-606-06 | 0,6 x 60 |
| 40-606-08 | 0,8 x 60 |



**Tränenwegkanüle, stumpf, gebogen, 0,6 x 23,5 mm /
Lacrimal canula, blunt, curved, 0.6 x 23.5 mm**

40-607-06

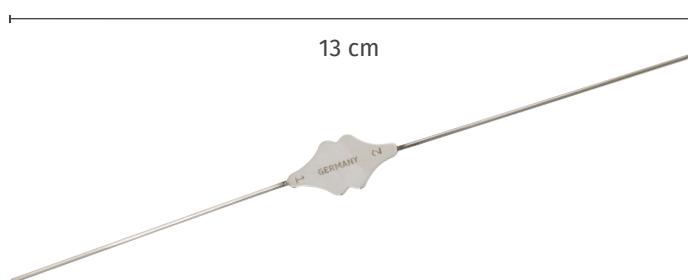

**Bowman Speichelgangsonde,
Neusilber, gerade, zylindrisch, 13 cm /
Bowman salivary duct probe,
alpaca, straight, cylindrical, 13 cm**

| Art.-Nr./No. | Größe / Size | ø (mm) |
|--------------|--------------|---------|
| 40-610-40 | (0000/000) | 0,6/0,7 |
| 40-610-20 | (00/0) | 0,8/0,9 |
| 40-610-12 | (1/2) | 1,0/1,2 |
| 40-610-34 | (3/4) | 1,3/1,4 |

06 Speichelgang Salivary Duct

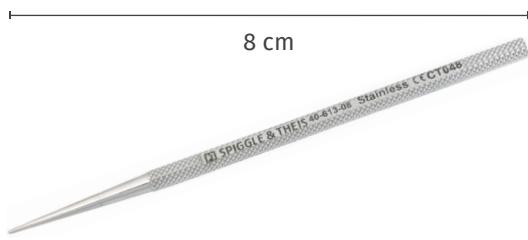

8 cm

**Ruedemann Dilator für Kleinkinder, 8 cm /
Ruedemann dilator for infants, 8 cm**

40-613-08



11 cm

**Wilder Dilator, 11 cm /
Wilder dilator, 11 cm**

Art.-Nr./No.

Größe / Size

40-615-01

1

40-615-02

2

40-615-03

3



14 cm

**Speichelgang-Sonden-Set,
doppelseitig, biegsam, Nitinol, 6 Größen
(Ø 0,5/0,6 mm bis Ø 1,5/1,6 mm), 14 cm /
Salivary duct probe set,
double ended, bendable, Nitinol, 6 sizes
(Ø 0.5/0.6 mm up to Ø 1.5/1.6 mm), 14 cm**

40-617-00

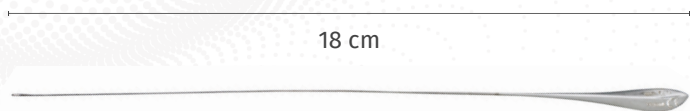

18 cm

**Seiffert Speichelgangsonde, Silber, 0,5 mm, 18 cm /
Seiffert salivary duct probe, silver, 0.5 mm, 18 cm**

10-729-18



07 Koagulation

Coagulation



**HF-Chirurgie-Gerät MD3,
80 Watt bipolar/80 Watt monopolar schneiden,
80 Watt monopolar koagulieren, Netzkabel /
HF surgery unit MD3,
80 Watt bipolar/80 Watt unipolar cutting,
80 Watt unipolar coagulation, power cable**

80-000-80



**Einpedal-Fußschalter für HF-Chirurgie-Gerät MD3 /
One pedal foot switch for HF-surgery-unit MD3**

| Art.-Nr./No. | Beschreibung / Description |
|--------------|---|
| 80-003-01 | Praxisversion / Medical practice version |
| 80-003-02 | OP-Version / OR version |

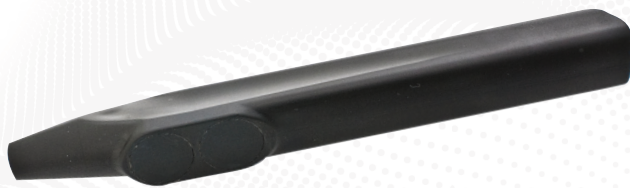

**Elektroden-Handgriff,
monopolar, ohne Schalter,
für 4 mm Elektroden, autoklavierbar /
Electrode handle,
monopolar, without switch,
for 4 mm electrodes, autoclavable**

80-004-00



**Elektroden-Handgriff,
monopolar, mit Schalter,
für 4 mm Elektroden, autoklavierbar /
Electrode handle,
monopolar, with switch,
for 4 mm electrodes, autoclavable**

80-005-00



**Elektroden-Handgriff,
monopolar, mit 2 Schaltern,
für 4 mm Elektroden, autoklavierbar /
Electrode handle,
monopolar, with 2 switches,
for 4 mm electrodes, autoclavable**

80-006-00

07 Koagulation

Coagulation



**Silikon Neutral-Elektrode,
8 x 15 cm, 4 m Kabel, passend für /
Silicone neutral electrode,
8 x 15 cm, 4 m cable, fitting to
Micromed/Martin/Berchthold/Aesculap**

80-010-40



**Silikon Neutral-Elektrode,
17 x 30 cm, 4 m Kabel, passend für /
Silicone neutral electrode,
17 x 30 cm, 4 m cable, fitting to
Micromed/Martin/Berchthold/Aesculap**

80-011-40



**Halteband für Neutralelektrode,
Gummi, 75 cm
Holding band for neutral electrode,
rubber, 75 cm**

80-012-75



**Kabel für Einmal-Neutral-Elektrode,
4,5 m, passend für /
Cable for single use neutral electrode,
4.5 m compatible to
Micromed/Martin/Erbe/
Berchthold/Aesculap/Integra/ICC/ACC/T-Serie**

80-013-00



07 Monopolares Zubehör, monopolare Anschlusskabel, autoklavierbar

Monopolar Accessory, monopolar connecting cable, autoclavable



Monopolares Anschlusskabel für SPIGGLE & THEIS Elektroden-Handgriffe, passend für /
Monopolar connecting cable for SPIGGLE & THEIS electrode handles, compatible to
Sutter/Martin/Berchtold/Aesculap/Integra/SPIGGLE & THEIS, 4,5 m

80-007-45



Monopolares Anschlusskabel für SPIGGLE & THEIS Elektroden-Handgriffe, passend für /
Monopolar connecting cable for SPIGGLE & THEIS electrode handles, compatible to
Erbe ICC/ACC, Wolf/Storz, 4,5 m

80-008-45



Für Erbe Elektroden-Handgriffe, passend für /
For Erbe electrode handles, compatible to
Erbe ICC/ACC, Wolf/Storz, 4,5 m

80-009-45



Für Instrumente, passend für /
For instruments, compatible to
Sutter/Martin/Berchtold/Aesculap/Integra/SPIGGLE & THEIS, 4 mm, 4,5 m

80-014-45



Für Instrumente, passend für /
For instruments, compatible to
Erbe ICC/ACC, Wolf/Storz autoklavierbar, 4 mm, 4,5 m

80-015-45



Monopolares Anschlusskabel für Instrumente, 4 mm, 4,5 m /
Monopolar connecting cable for instruments, 4 mm, 4,5 m

Art.-Nr./No.

Beschreibung / Description

80-045-15

passend für Valleylab /
compatible with Valleylab

80-046-45

passend für Covidien /
compatible with Covidien

08 Bipolares Zubehör, bipolare Anschlusskabel

Bipolar Accessory, bipolar connecting cable



Passend für /
Compatible to
Olympus/Söring/Coa/Erbe-Vio Intl.

| Art.-Nr./No. | Länge / Length (m) |
|--------------|--------------------|
| 80-016-50 | 4,5 |



Passend für /
Compatible to
Sutter/Martin/Berchtold/Aesculap/Integra/
SPIGGLE & THEIS

| Art.-Nr./No. | Länge / Length (m) |
|--------------|--------------------|
| 80-017-30 | 3,0 |
| 80-017-50 | 4,5 |



Passend für /
Compatible to
Erbe/Storz/Wolf

| Art.-Nr./No. | Länge / Length (m) |
|--------------|--------------------|
| 80-018-30 | 3,0 |
| 80-018-50 | 4,5 |



Passend für /
Compatible to
Valleylab/Lamidey/EMC/Bowa

| Art.-Nr./No. | Länge / Length (m) |
|--------------|--------------------|
| 80-019-30 | 3,0 |
| 80-019-50 | 4,5 |



Für bipolare Scheren, passend für /
For bipolar scissors, compatible to
Sutter/Martin/Berchtold/Aesculap/
Integra/SPIGGLE & THEIS, autoklavierbar

| Art.-Nr./No. | Länge / Length (m) |
|--------------|--------------------|
| 80-020-30 | 3,0 |
| 80-020-50 | 4,5 |



07 Koagulation

Coagulation



Bipolares Anschlusskabel für bipolare Scheren, passend für Erbe/Storz/Wolf /
Bipolar connecting cable for bipolar scissors, compatible with Erbe/Storz/Wolf

| Art.-Nr./No. | Länge / Length (m) |
|--------------|--------------------|
| 80-022-30 | 3,0 |
| 80-022-50 | 5,0 |

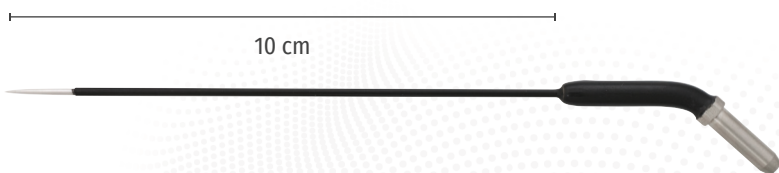

Nadelelektrode, spitz, gewinkelt, 4 mm Ansatz, AL 10 cm /
Needle electrode, pointed, angled, 4 mm plug, WL 10 cm

80-050-10



Kugelelektrode, 2 mm, gewinkelt, 4 mm Ansatz, AL 10 cm /
Ball electrode, 2 mm, angled, 4 mm plug, WL 10 cm

80-051-10

Monopolare Elektrode, 4 mm Ansatz /
Monopolar electrode, 4 mm plug

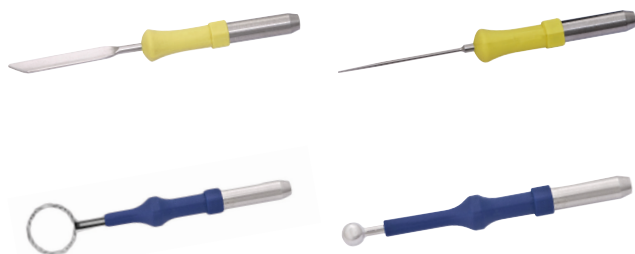

| Art.-Nr./No. | |
|--------------|---|
| 80-052-01 | Messer, gerade / knife, straight |
| 80-052-02 | Nadel, gerade / needle, straight |
| 80-052-03 | Schlinge 5 mm, gerade / loop 5 mm, straight |
| 80-052-04 | Kugel 4 mm, gerade / ball 4 mm, straight |
| 80-052-05 | Kugel 2 mm, gerade / ball 2 mm, straight |

07 Koagulation Coagulation

12 / 14 / 17,5 / 18,5 cm

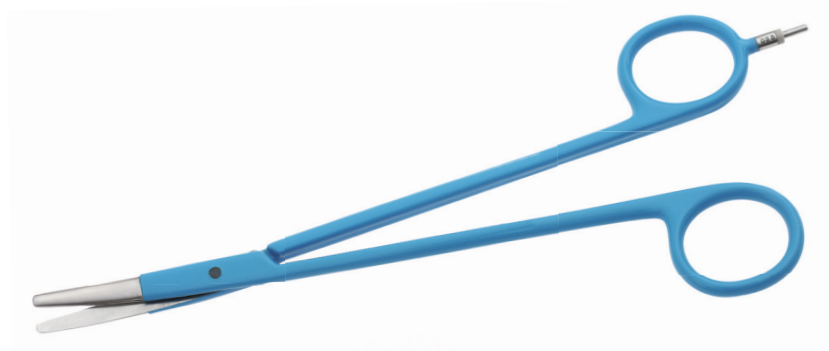

80-083-18
Standard Blatt / standard blade

80-080-13 80-081-14 80-082-17
Feines Blatt / fine blade

Bipolare Präparierschere, gebogen / Bipolar dissecting scissors, curved

| Art.-Nr./No. | Länge / Length (cm) |
|--------------|---------------------|
| 80-080-13 | 12,0 |
| 80-081-14 | 14,0 |
| 80-082-17 | 17,5 |
| 80-083-18 | 18,5 |



07 Monopolare Koagulations-Saugrohre, gewinkelt, Saugkontrolle

Monopolar Coagulation Suction Tubes, angled, Suction Control

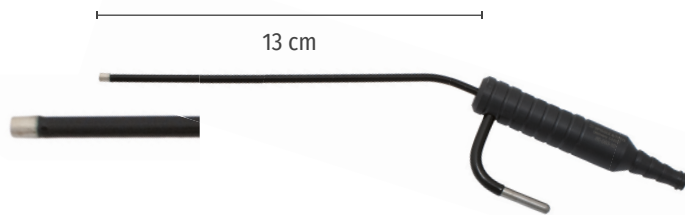

3 mm AD, 3,5 mm Kugel, AL 13 cm
3 mm OD, 3.5 mm ball end, WL 13 cm

.....
 80-060-10



AL / WL 25,5 cm

| Art.-Nr./No. | AD/OD (mm) | Kugel/Ball (mm) |
|--------------|------------|-----------------|
| 80-061-26 | 3,5 | 3,5 |
| 80-062-26 | 4,0 | 4,0 |



4 mm AD, 4 mm Kugel, AL 28 cm
4 mm OD, 4 mm ball end, WL 28 cm

.....
 80-063-30

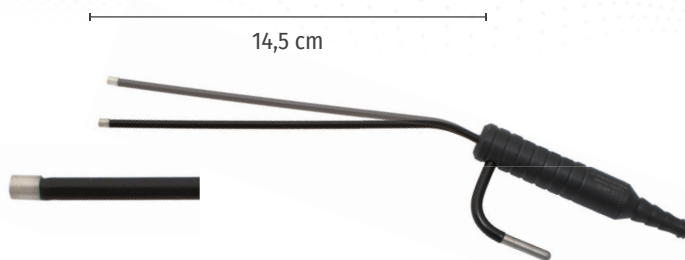

Biegsam, 4,3 mm AD, 4,3 mm Kugel, AL 14,5 cm
Flexible, 4.3 mm OD, 4.3 mm ball end, WL 14.5 cm

.....
 80-064-13

07 Bipolare Pinzetten

Bipolar Forceps

Bis heute stellt das Verkleben beim Koagulieren mit bipolaren Pinzetten ein verbreitetes Problem für den Operateur dar. **NON-STICK Bipolare Pinzetten** lösen dieses Problem.

Punktuelle Überhitzungen werden vermieden. Das Gewebe löst sich leicht von der Pinzette.

Diese Eigenschaften bleiben bei ordnungsgemäßer Anwendung über die gesamte Lebensdauer des Instruments erhalten.

An adhesion when coagulating with bipolar forceps is a common problem for the surgeon. Our **NON-STICK bipolar forceps** solve this problem.

No punctual overheating. Tissue detaches easily from forceps.

With correct usage these characteristics remain over the entire life span of the instrument.



Vorteile

- Kein Verkleben durch Arbeitsteile aus massivem Silber mit Goldüberzug
- Präzises Arbeiten ohne Unterbrechungen
- Perfekte Parallelführung durch Stopp-Führungsstift
- Flächiges Koagulieren durch "Perfect-Grip"-Arbeitsteil
- Autoklavierbar
- Passend für alle gängigen HF-Systeme durch Standard-Anschluss

Advantages

- No adhesion due to gold plated solid silver tips
- Precise working without interruptions
- Perfect parallel motion through guide pin
- Areal coagulation with "Perfect Grip" working part
- Autoclavable
- Standard adapter grants compatibility to all current HF-systems



07 Bipolare Pinzetten, X-FINE, NON-STICK, bajonett, Führungsstift

Bipolar Forceps, X-FINE, NON-STICK, bayonet, guide pin



17 / 20 / 23 / 25 cm

Spitze gerade / Tip straight

| Art.-Nr./ No. | Länge / Length (cm) | Spitze / Tip (mm) |
|------------------|------------------------|----------------------|
| 80-150-17 | 17 | 0,4 x 4,0 |
| 80-150-20 | 20 | 0,4 x 4,0 |
| 80-150-23 | 23 | 0,4 x 4,0 |
| 80-150-25 | 25 | 0,4 x 4,0 |
| 80-152-17 | 17 | 0,7 x 4,0 |
| 80-152-20 | 20 | 0,7 x 4,0 |
| 80-152-23 | 23 | 0,7 x 4,0 |



20 / 23 cm

Spitze aufwärts gewinkelt / Tip upwards angled

| Art.-Nr./ No. | Länge / Length (cm) | Spitze / Tip (mm) |
|------------------|------------------------|----------------------|
| 80-156-20 | 20 | 0,4 x 4,0 |
| 80-156-23 | 23 | 0,4 x 4,0 |



20 / 23 cm

Spitze abwärts gewinkelt / Tip downwards angled

| Art.-Nr./ No. | Länge / Length (cm) | Spitze / Tip (mm) |
|------------------|------------------------|----------------------|
| 80-158-20 | 20 | 0,4 x 4,0 |
| 80-158-23 | 23 | 0,4 x 4,0 |

07 Bipolare Pinzetten, NON-STICK, Führungsstift

Bipolar Forceps, NON-STICK, guide pin

16 / 19,5 / 22 cm



Gerade / Straight

| Art.-Nr./ No. | Länge / Length (cm) | Spitze / Tip (mm) |
|------------------|------------------------|----------------------|
| 80-100-16 | 16,0 | 0,5 x 8,0 |
| 80-100-19 | 19,5 | 0,5 x 8,0 |
| 80-101-16 | 16,0 | 1,0 x 8,0 |
| 80-101-19 | 19,5 | 1,0 x 8,0 |
| 80-101-22 | 22,0 | 1,0 x 8,0 |
| 80-103-16 | 16,0 | 2,0 x 8,0 |
| 80-103-19 | 19,5 | 2,0 x 8,0 |

16 / 19,5 / 25 cm



Gerade, Spitze gewinkelt / Straight, tip angled

| Art.-Nr./ No. | Länge / Length (cm) | Spitze / Tip (mm) |
|------------------|------------------------|----------------------|
| 80-105-16 | 16,0 | 0,5 x 8,0 |
| 80-105-19 | 19,5 | 0,5 x 8,0 |
| 80-106-16 | 16,0 | 1,0 x 8,0 |
| 80-106-19 | 19,5 | 1,0 x 8,0 |
| 80-106-25 | 25,0 | 1,0 x 8,0 |
| 80-107-16 | 16,0 | 2,0 x 8,0 |
| 80-107-19 | 19,5 | 2,0 x 8,0 |

16 / 19,5 cm



Bajonett / Bayonet

| Art.-Nr./ No. | Länge / Length (cm) | Spitze / Tip (mm) |
|------------------|------------------------|----------------------|
| 80-109-16 | 16,0 | 0,2 x 6,0 |
| 80-110-16 | 16,0 | 0,5 x 8,0 |
| 80-110-19 | 19,5 | 0,5 x 8,0 |
| 80-111-16 | 16,0 | 1,0 x 8,0 |
| 80-111-19 | 19,5 | 1,0 x 8,0 |
| 80-112-16 | 16,0 | 2,0 x 8,0 |
| 80-112-19 | 19,5 | 2,0 x 8,0 |

19,5 / 23 cm



Bajonett / Bayonet

| Art.-Nr./ No. | Länge / Length (cm) | Spitze / Tip (mm) |
|------------------|------------------------|----------------------|
| 80-113-19 | 19,5 | 0,2 x 6,0 |
| 80-113-23 | 23,0 | 0,2 x 6,0 |
| 80-114-19 | 19,5 | 0,5 x 6,0 |
| 80-115-19 | 19,5 | 1,0 x 6,0 |
| 80-116-19 | 19,5 | 1,5 x 6,0 |



07 Bipolare Pinzetten, NON-STICK, Führungsstift

Bipolar Forceps, NON-STICK, guide pin



Bajonett, Spitze nach oben gewinkelt, 19,5 cm /
Bayonet, tip angled upwards, 19.5 cm

| Art.-Nr./No. | Spitze / Tip (mm) |
|--------------|-------------------|
| 80-117-19 | 0,2 x 8,0 |
| 80-118-19 | 1,0 x 8,0 |
| 80-119-19 | 2,0 x 8,0 |



Bajonett, Spitze nach oben gewinkelt, 14 mm,
4 mm unisoliert, 1,5 mm, 19,5 cm /
Bayonet, tip upwards angled, 14 mm, 4 mm
unisolated, 1.5 mm, 19.5 cm

80-120-19



Nach Meuser, 60° gebogen, 2 mm, 18 cm /
Meuser, 60° curved, 2 mm, 18 cm

80-121-18



Kniegebogen, extra fein, 0,2 x 8,0 mm, 16,5 cm /
Angled, very fine, 0.2 x 8.0 mm, 16.5 cm

80-123-16

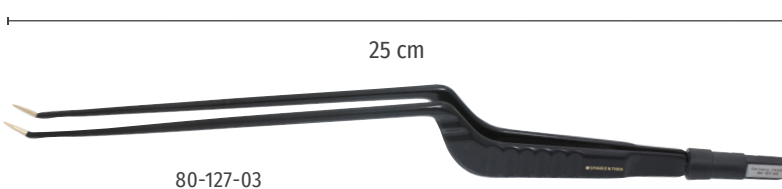

Bajonett, Spitze nach oben gewinkelt, 25 cm /
Bayonet, tip upwards angled, 25 cm

| Art.-Nr./No. | Spitze / Tip (mm) |
|--------------|--|
| 80-127-03 | 0,3 x 8,0 |
| 80-127-07 | 0,7 x 8,0 |
| 80-127-12 | 1,2 x 8,0 |
| 80-127-20 | 2,0 x 8,0 |
| 80-129-12 | 1,2 x 14,0 8 mm unisoliert unisolated |

80-127-03



07 Bipolare Pinzetten, NON-STICK, bajonett, Führungsstift

Bipolar Forceps, NON-STICK, bayonet, guide pin



**Spitze nach unten gewinkelt, 25 cm /
Tip downwards angled, 25 cm**

| Art.-Nr./No. | Spitze / Tip (mm) |
|--------------|-------------------|
| 80-128-03 | 0,3 x 8,0 |
| 80-128-07 | 0,7 x 8,0 |
| 80-128-12 | 1,2 x 8,0 |
| 80-128-20 | 2,0 x 8,0 |



Spitze gerade, 25 cm / Tip straight

| Art.-Nr./No. | Spitze / Tip (mm) |
|--------------|-------------------|
| 80-125-03 | 0,3 x 8,0 |
| 80-125-07 | 0,7 x 8,0 |
| 80-125-12 | 1,2 x 8,0 |
| 80-125-20 | 2,0 x 8,0 |

07 Bipolare Saugpinzetten

Bipolar Suction Forceps



**Nach Meuser mit Absaugung,
60° gebogen, 3,2 mm, 21 cm /
Meuser with suction,
60° upcurved, 3.2 mm, 21 cm**

80-122-18



**Saugunterbrecher, bajonett, 20 cm /
With suction control, bayonet, 20 cm**

| Art.-Nr./No. | Spitze / Tip (mm) |
|--------------|-------------------|
| 80-183-14 | 1,4 x 8,0 |
| 80-183-20 | 2,2 x 8,0 |



07 Koagulation

Coagulation



**Siebkorb mit Deckel, 3/4,
Edelstahl, gelocht, 405 x 255 x 75 mm /
Storage and cleaning tray with lid,
3/4, stainless steel, perforated,
405 x 255 x 75 mm**

80-260-34

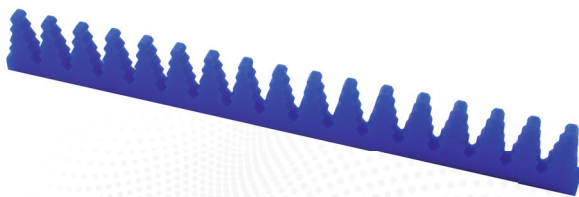

**Silikonhalterung, Typ 1,
Bäumchen, T-Profil, blau, 24 cm /
Silicone holder, type 1,
tree shaped, T-profile, blue, 24 cm**

80-270-24

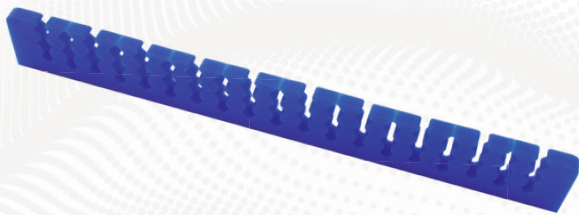

**Silikonhalterung, Typ 2,
Universal, T-Profil, blau, 24 cm /
Silicone holder, type 2,
universal, T-profile, blue, 24 cm**

80-272-24

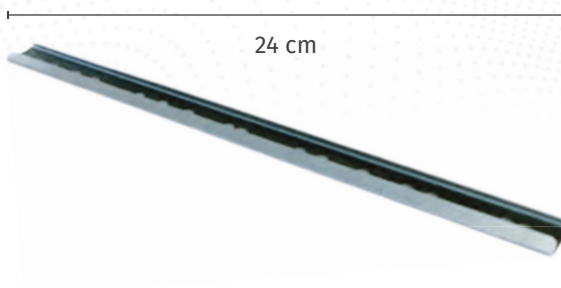

**Leiste für Silikonhalterungen,
Edelstahl, T-Profil, 24 cm /
Bar for silicone holders,
stainless steel, t-profile, 24 cm**

80-275-24



**Schraube, Edelstahl, M2, 9 x 16 mm /
Screw, stainless steel, M2, 9 x 16 mm**

80-280-00

07 Bipolare Elektroden, Titan

Bipolar Electrodes, Titanium

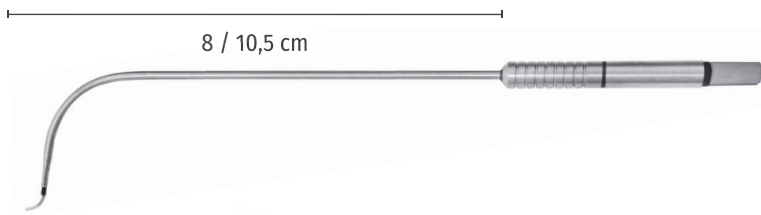

Nach Meuser / Meuser

| Art.-Nr./No. | | AL / WL (cm) |
|--------------|-----|--------------|
| 80-184-22 | 90° | 8,0 |
| 80-185-22 | 45° | 10,5 |

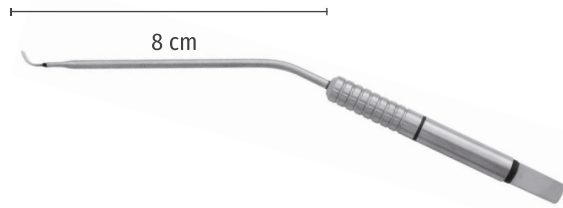

Gewinkelt, für Nase, AL 8 cm Angled, for nose, WL 8 cm

80-190-08

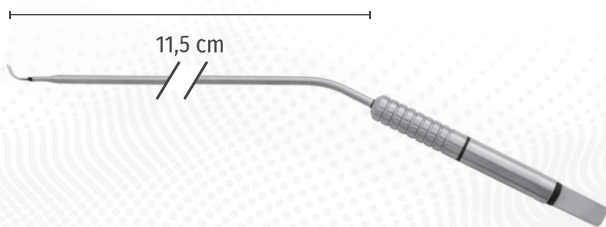

Gewinkelt, für Tonsillen, AL 11,5 cm Angled, for tonsils, WL 11.5 cm

80-190-11

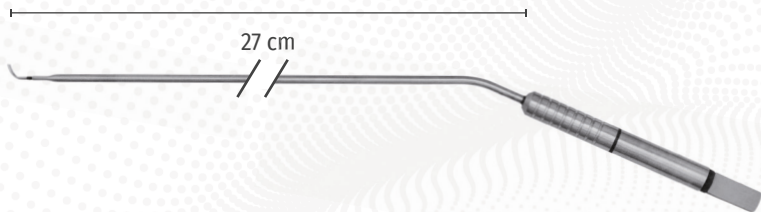

Gewinkelt, für Larynx, AL 27 cm Angled, for larynx, WL 27 cm

50-365-27

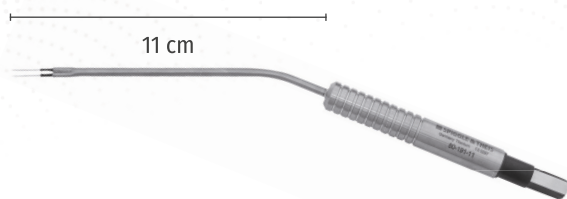

Nadel-Elektrode, gewinkelt, für Nasenmuschel, AL 11 cm Needle-electrode, angled, for turbinates, WL 11 cm

80-191-11



08 Tracheotomie, Weichteile, Allgemeines

Tracheotomy, Neck Dissection, Miscellaneous

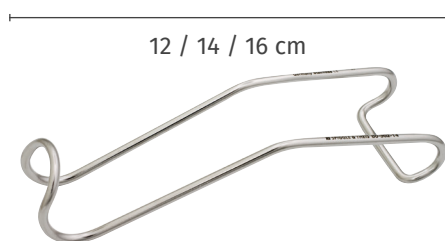

**Sternberg Lippenhaken /
Sternberg lip retractor**

| Art.-Nr./No. | Länge / Length (cm) |
|--------------|---------------------|
| 80-302-12 | 12 |
| 80-302-14 | 14 |
| 80-302-16 | 16 |



**Middeldorpf Wundhaken, Ringgriff /
Middeldorpf antrum retractor, ring handle**

| Art.-Nr./ No. | Maße / Dimensions (mm) | Länge / Length (cm) |
|------------------|---------------------------|------------------------|
| 80-306-17 | 15,0 x 16,5 | 22 |
| 80-306-22 | 20,0 x 22,0 | 23 |
| 80-306-30 | 25,0 x 30,0 | 24 |

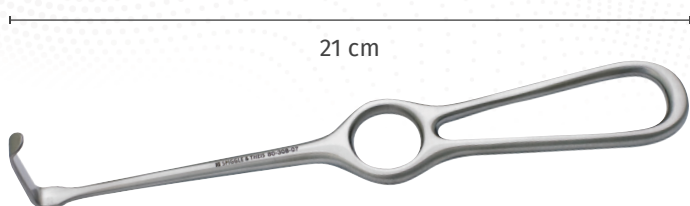

**Kocher-Langenbeck Wundhaken, Ringgriff, 21 cm /
Kocher-Langenbeck retractor, ring handle, 21 cm**

| Art.-Nr./ No. | Maße / Dimensions (mm) |
|------------------|---------------------------|
| 80-308-06 | 25,0 x 6,0 |
| 80-308-07 | 35,0 x 8,0 |
| 80-308-10 | 35,0 x 11,0 |
| 80-308-15 | 35,0 x 15,0 |
| 80-308-20 | 60,0 x 20,0 |

08 Tracheotomie, Weichteile, Allgemeines

Tracheotomy, Neck Dissection, Miscellaneous



Langenbeck Wundhaken, Ringgriff /
Langenbeck retractor, ring handle

| Art.-Nr./ No. | Maße / Dimensions (mm) | Länge / Length (cm) |
|------------------|---------------------------|------------------------|
| 80-309-11 | 31,0 x 11,0 | 23,0 |
| 80-309-14 | 31,0 x 14,0 | 23,0 |
| 80-309-16 | 31,0 x 16,0 | 23,0 |
| 80-309-41 | 41,0 x 11,0 | 22,0 |
| 80-309-51 | 51,0 x 11,0 | 21,0 |



Volkman Wundhaken, Ringgriff, 23 cm /
Volkman retractor, ring handle, 23 cm

| Art.-Nr./No. | Beschreibung / Description |
|--------------|------------------------------------|
| 80-330-01 | 1-zinkig, scharf / 1 prong, sharp |
| 80-330-02 | 2-zinkig, scharf / 2 prongs, sharp |
| 80-330-03 | 3-zinkig, scharf / 3 prongs, sharp |
| 80-330-04 | 4-zinkig, scharf / 4 prongs, sharp |
| 80-330-06 | 6-zinkig, scharf / 6 prongs, sharp |
| 80-332-01 | 1-zinkig, stumpf / 1 prong, blunt |
| 80-332-02 | 2-zinkig, stumpf / 2 prongs, blunt |
| 80-332-03 | 3-zinkig, stumpf / 3 prongs, blunt |
| 80-332-04 | 4-zinkig, stumpf / 4 prongs, blunt |
| 80-332-06 | 6-zinkig, stumpf / 6 prongs, blunt |



Schönborn Schilddrüsenhaken, 6,5 x 13 mm, 20,5 cm /
Schönborn thyroid retractor, 6.5 x 13 mm, 20.5 cm

80-312-21



Senn-Miller Wundhaken,
doppelendig, 3 Zähne, 16,5 cm /
Senn-Miller retractor,
double ended, 3 teeth, 16.5 cm

| Art.-Nr./No. | Beschreibung / Description |
|--------------|----------------------------|
| 80-314-16 | stumpf / blunt |
| 80-315-16 | scharf / sharp |



08 Tracheotomie, Weichteile, Allgemeines

Tracheotomy, Neck Dissection, Miscellaneous

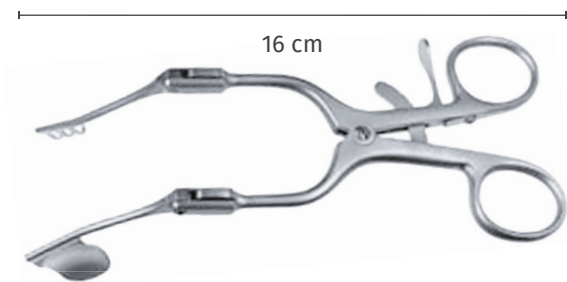

**Orbita Gelenksperrer,
3 Zähne links, Blatt rechts, 16 cm /
Orbita retractor,
3 prongs left, blade right, 16 cm**

| Art.-Nr./No. | Beschreibung / Description |
|--------------|----------------------------|
| 80-310-01 | Blatt links / blade left |
| 80-310-02 | Blatt rechts / blade right |



**Roux Wundhaken, doppelendig /
Roux retractor, double ended**

| Art.-Nr./No. | Maße / Dimensions (mm) | Länge / Length (cm) |
|--------------|----------------------------|---------------------|
| 80-318-01 | 20,8 x 25,0 / 28,5 x 30,5 | 14,5 |
| 80-318-02 | 25,5 x 28,0 / 37,0 x 33,15 | 15,5 |
| 80-318-03 | 30,0 x 31,5 / 41,9 x 38,5 | 16,5 |



**Baby-Roux Haken,
doppelendig, 18 x 17 und 24 x 21 mm, 12,5 cm /
Baby-Roux retractor,
double ended, 18 x 17 and 24 x 21 mm, 12,5 cm**

80-317-00



**Trachealhäkchen, glatter Griff, 17 cm /
Trachea hook, flat handle, 17 cm**



| Art.-Nr./No. | Beschreibung / Description |
|--------------|------------------------------------|
| 80-340-01 | 1-zinkig, scharf / 1 prong, sharp |
| 80-340-02 | 2-zinkig, scharf / 2 prongs, sharp |
| 80-340-03 | 3-zinkig, scharf / 3 prongs, sharp |
| 80-340-04 | 4-zinkig, scharf / 4 prongs, sharp |
| 80-342-01 | 1-zinkig, stumpf / 1 prong, blunt |
| 80-342-02 | 2-zinkig, stumpf / 2 prongs, blunt |
| 80-342-03 | 3-zinkig, stumpf / 3 prongs, blunt |
| 80-342-04 | 4-zinkig, stumpf / 4 prongs, blunt |

08 Tracheotomie, Weichteile, Allgemeines

Tracheotomy, Neck Dissection, Miscellaneous

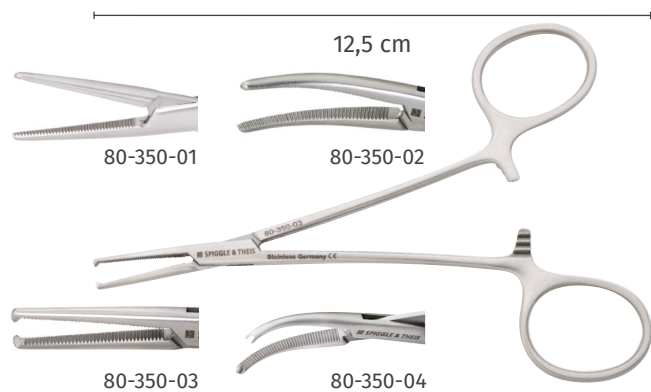

**Halsted-Mosquito-Klemme, 12,5 cm /
Halsted-Mosquito artery forceps, 12.5 cm**

| Art.-Nr./No. | Beschreibung / Description |
|--------------|-------------------------------------|
| 80-350-01 | gerade, anat. / straight anat. |
| 80-350-02 | gebogen, anat. / curved, anat. |
| 80-350-03 | gerade, chir. / straight, 1:2 teeth |
| 80-350-04 | gebogen, chir. / curved, 1:2 teeth |

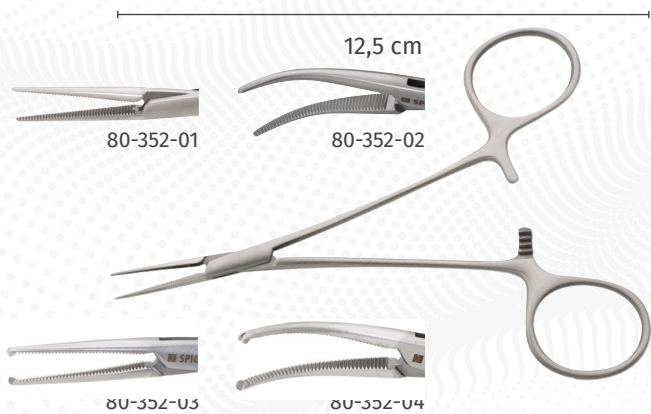

**Halsted-Mosquito-Klemme, mikro, 12,5 cm /
Halsted-Mosquito artery forceps, micro, 12.5 cm**

| Art.-Nr./No. | Beschreibung / Description |
|--------------|-------------------------------------|
| 80-352-01 | gerade, anat. / straight anat. |
| 80-352-02 | gebogen, anat. / curved, anat. |
| 80-352-03 | gerade, chir. / straight, 1:2 teeth |
| 80-352-04 | gebogen, chir. / curved, 1:2 teeth |

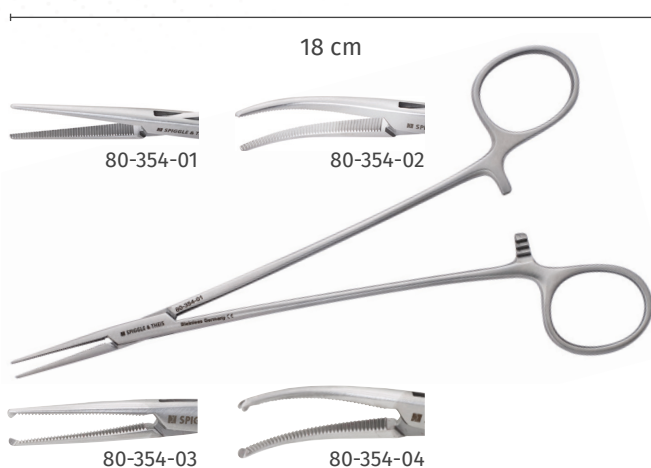

**Halsted-Mosquito-Klemme, 18 cm /
Halsted-Mosquito artery forceps, 18 cm**

| Art.-Nr./No. | Beschreibung / Description |
|--------------|-------------------------------------|
| 80-354-01 | gerade, anat. / straight anat. |
| 80-354-02 | gebogen, anat. / curved, anat. |
| 80-354-03 | gerade, chir. / straight, 1:2 teeth |
| 80-354-04 | gebogen, chir. / curved, 1:2 teeth |



08 Tracheotomie, Weichteile, Allgemeines

Tracheotomy, Neck Dissection, Miscellaneous

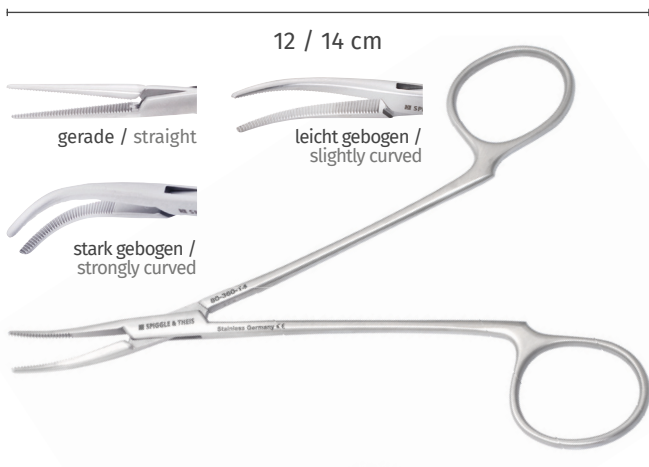

Präparierklemme ohne Sperre, anatomisch / Artery forceps without ratchet, anatomical

| Art.-Nr./No. | Länge / Length (cm) | Beschreibung / Description |
|--------------|------------------------|----------------------------------|
| 80-356-12 | 12,0 | gerade/ straight |
| 80-359-14 | 14,0 | gerade / straight |
| 80-357-12 | 12,0 | leicht gebogen / slightly curved |
| 80-360-14 | 14,0 | leicht gebogen / slightly curved |
| 80-361-14 | 14,0 | stark gebogen/ strongly curved |



Pean Arterienklemme, anatomisch, fein / Pean artery forceps, anatomical, fine

| Art.-Nr./No. | Länge / Length (cm) | Beschreibung / Description |
|--------------|------------------------|----------------------------|
| 80-365-14 | 14,0 | gerade/ straight |
| 80-365-16 | 16,5 | gerade / straight |
| 80-366-14 | 14,0 | gebogen / curved |
| 80-366-16 | 16,5 | gebogen / curved |

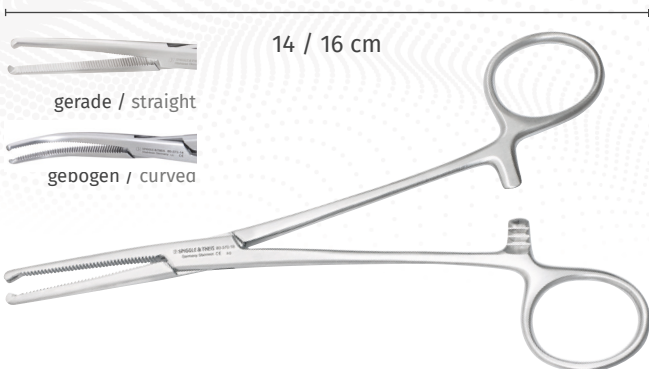

Kocher Arterienklemme, chirurgisch, fein / Kocher artery forceps, 1:2 teeth, fine

| Art.-Nr./No. | Länge / Length (cm) | Beschreibung / Description |
|--------------|------------------------|----------------------------|
| 80-370-14 | 14,0 | gerade/ straight |
| 80-370-16 | 16,0 | gerade / straight |
| 80-372-14 | 14,0 | gebogen / curved |
| 80-372-16 | 16,0 | gebogen / curved |

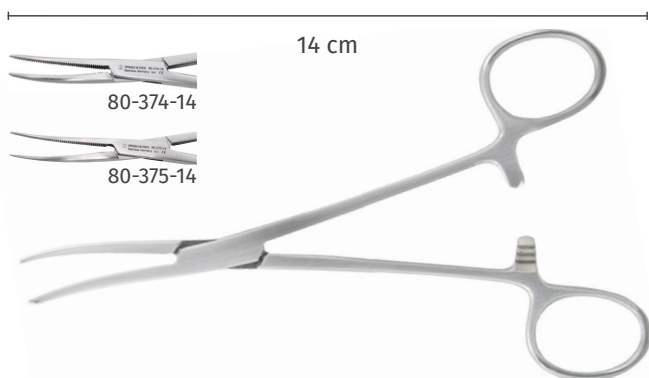

Crile Arterienklemme, anatomisch, gebogen, 14 cm / Crile artery forceps, anatomical, curved, 14 cm

| Art.-Nr./No. | Beschreibung / Description |
|--------------|----------------------------|
| 80-374-14 | normal/ standard |
| 80-375-14 | mikro / micro |

08 Tracheotomie, Weichteile, Allgemeines

Tracheotomy, Neck Dissection, Miscellaneous

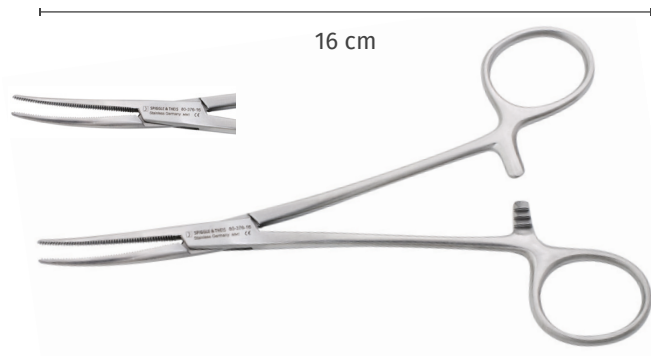

**Crile Arterienklemme, anatomisch, gebogen, 16 cm /
Crile artery forceps, anatomical, curved, 16 cm**

80-376-16

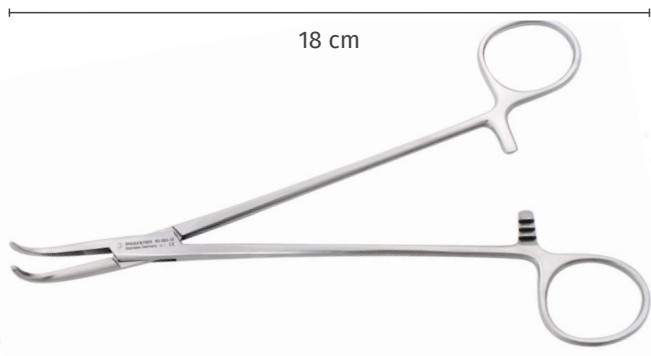

**Baby-Adson Präparierklemme, 90° gebogen, 18 cm /
Baby-Adson artery forceps, 90° curved, 18 cm**

80-380-18



**Rochester-Pean Arterienklemme, anatomisch, gerade /
Rochester-Pean artery forceps, anatomical, straight**

| Art.-Nr./No. | Länge / Length (cm) |
|--------------|---------------------|
| 80-382-18 | 18,5 |
| 80-382-20 | 20,0 |



**Rochester-Pean Arterienklemme, anatomisch, gebogen /
Rochester-Pean artery forceps, anatomical, curved**

| Art.-Nr./No. | Länge / Length (cm) |
|--------------|---------------------|
| 80-383-18 | 18,5 |
| 80-383-20 | 20,0 |
| 80-383-22 | 22,0 |



08 Tracheotomie, Weichteile, Allgemeines

Tracheotomy, Neck Dissection, Miscellaneous

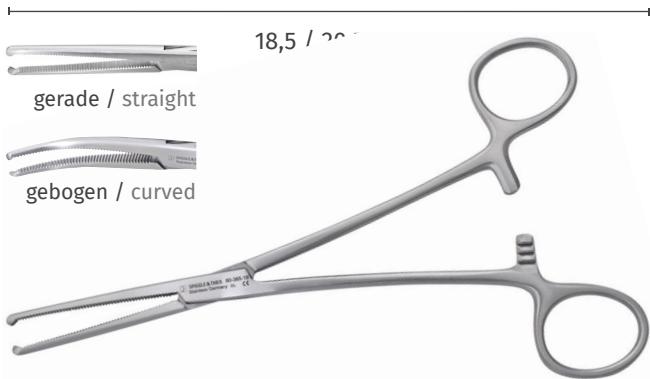

**Ochsner-Kocher Arterienklemme, chirurgisch, 1:2 Zähne /
Ochsner-Kocher artery forceps, 1:2 teeth**

| Art.-Nr./No. | Länge / Length (cm) | Beschreibung / Description |
|--------------|------------------------|----------------------------|
| 80-385-18 | 18,5 | gerade/ straight |
| 80-385-20 | 20,5 | gerade / straight |
| 80-387-18 | 18,5 | gebogen / curved |
| 80-387-20 | 20,5 | gebogen / curved |

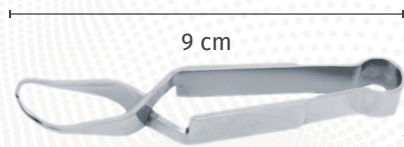

**Schädel Tuchklemme, scharf, gebogen, 9 cm /
Schädel towel clamp, sharp, curved, 9 cm**

80-390-09



**Backhaus Tuchklemme, scharf, gebogen /
Backhaus towel clamp, sharp, curved**

| Art.-Nr./No. | Länge / Length (cm) |
|--------------|---------------------|
| 80-392-09 | 9,0 |
| 80-392-11 | 11,0 |
| 80-392-13 | 13,5 |

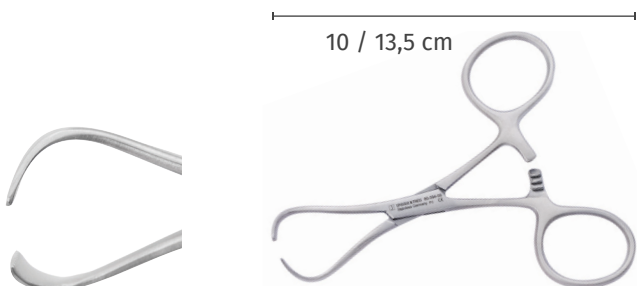

**Edna-Lorna Tuchklemme, stumpf, gerade, für Papiertücher /
Edna-Lorna towel clamp, blunt, straight, for paper towels**

| Art.-Nr./No. | Länge / Length (cm) |
|--------------|---------------------|
| 80-394-09 | 10,0 |
| 80-394-13 | 13,5 |

08 Tracheotomie, Weichteile, Allgemeines

Tracheotomy, Neck Dissection, Miscellaneous

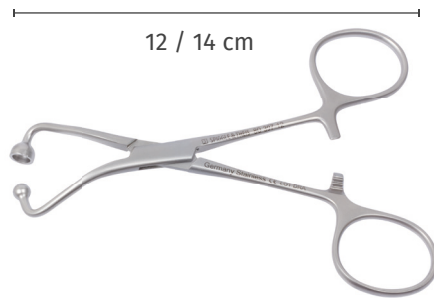

Tuchklemme zum schonenden Fassen von Papiertüchern, Kugel, gebogen /
Towel clamp for careful holding of paper towels, ball-end, curved

| Art.-Nr./No. | Länge / Length (cm) |
|--------------|---------------------|
| 80-397-12 | 12 |
| 80-397-14 | 14 |

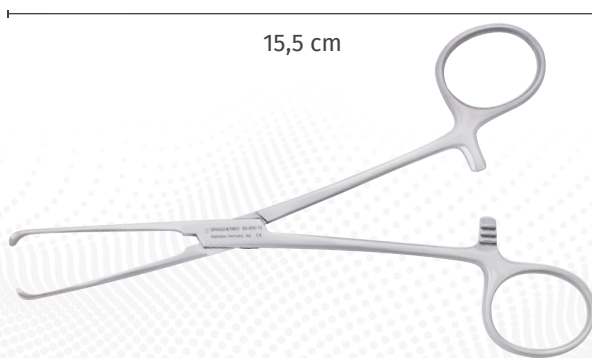

Allis Gewebe-Fasszange, gerade, 4:5 Zähne, 15,5 cm /
Allis tissue holding forceps, straight, 4:5 teeth, 15.5 cm

80-400-15

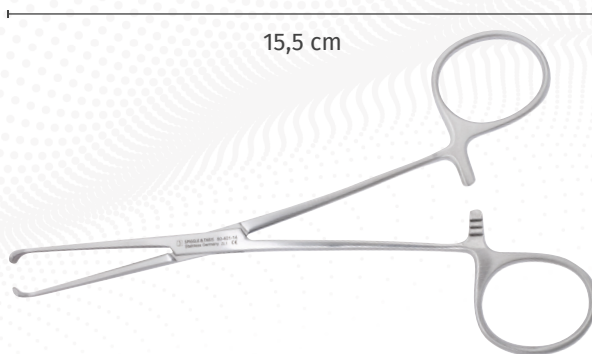

Baby-Allis Gewebe-Fasszange, gerade, 4:5 Zähne, 15,5 cm /
Baby-Allis tissue holding forceps, straight, 4:5 teeth, 15.5 cm

80-401-14

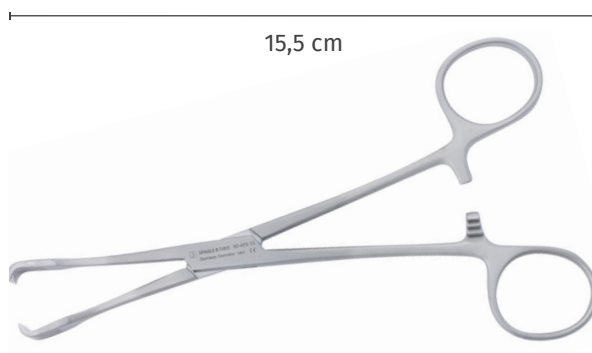

Braun Haken-Zange, 4:4 Zähne, scharf, gerade, 15,5 cm /
Braun hook forceps, 4:4 teeth, sharp, straight, 15.5 cm

80-403-15



08 Tracheotomie, Weichteile, Allgemeines

Tracheotomy, Neck Dissection, Miscellaneous

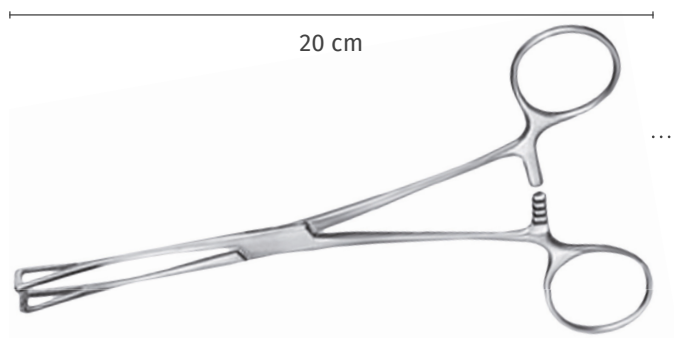

**Duval Gewebefasszange, gerade, 15 mm breit, 20 cm /
Duval tissue forceps, straight, 15 mm wide, 20 cm**

80-405-20

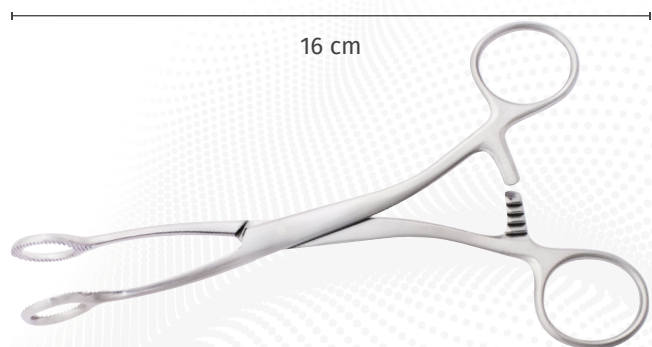

**Collin Zungenzange, gerade, 16 cm /
Collin tongue forceps, straight, 16 cm**

80-407-16



Cooper Schere, gerade / Cooper scissors, straight

| Art.-Nr./No. | Länge / Length (cm) | Beschreibung / Description |
|--------------|------------------------|-----------------------------|
| 80-440-13 | 13,0 | spitz-spitz / sharp-sharp |
| 80-440-15 | 14,5 | spitz-spitz / sharp-sharp |
| 80-442-13 | 13,0 | spitz-stumpf / sharp-blunt |
| 80-442-15 | 14,5 | spitz-stumpf / sharp-blunt |
| 80-444-13 | 13,0 | stumpf-stumpf / blunt-blunt |
| 80-444-15 | 14,5 | stumpf-stumpf / blunt-blunt |

08 Tracheotomie, Weichteile, Allgemeines

Tracheotomy, Neck Dissection, Miscellaneous



Cooper Schere, gebogen / Cooper scissors, curved

| Art.-Nr./No. | Länge / Length (cm) | Beschreibung / Description |
|--------------|---------------------|-----------------------------|
| 80-446-13 | 13,0 | spitz-spitz / sharp-sharp |
| 80-446-15 | 14,5 | spitz-spitz / sharp-sharp |
| 80-448-13 | 13,0 | spitz-stumpf / sharp-blunt |
| 80-448-15 | 14,5 | spitz-stumpf / sharp-blunt |
| 80-450-13 | 13,0 | stumpf-stumpf / blunt-blunt |
| 80-450-15 | 14,5 | stumpf-stumpf / blunt-blunt |



Mayo-Stille Schere, stumpf-stumpf, 15 cm / Mayo-Style scissors, blunt-blunt, 15 cm

| Art.-Nr./No. | Beschreibung / Description |
|--------------|----------------------------|
| 80-455-15 | gerade / straight |
| 80-457-15 | gebogen / curved |



Mayo-Stille Schere, Hartmetall, stumpf-stumpf, 15 cm / Mayo-Style scissors, tungsten carbide, blunt-blunt, 15 cm

| Art.-Nr./No. | Beschreibung / Description |
|--------------|----------------------------|
| 80-459-15 | gerade / straight |
| 80-460-15 | gebogen / curved |



Lister Verbandsschere, gewinkelt / Lister bandage scissors, angled

| Art.-Nr./No. | Länge / Length (cm) |
|--------------|---------------------|
| 80-465-15 | 14,5 |
| 80-465-18 | 18,0 |
| 80-465-20 | 20,0 |



08 Tracheotomie, Weichteile, Allgemeines
Tracheotomy, Neck Dissection, Miscellaneous

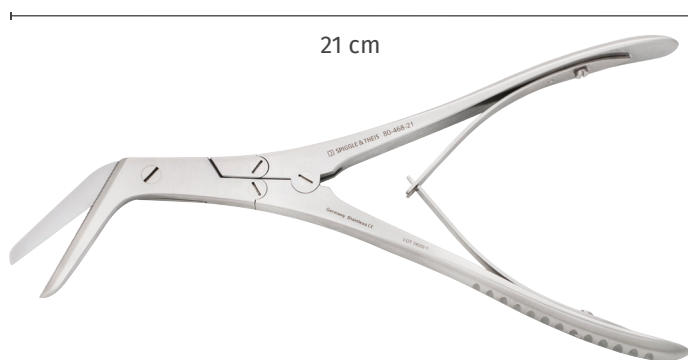

**Kilian Laryngofissur-Schere,
 gewinkelt, gezahnt, 21 cm /
 Kilian laryngectomy scissors,
 angled, serrated, 21 cm**

80-468-21



**Kocher Führungssonde,
 mit Öffnung, 11 mm, 16 cm /
 Kocher director,
 with opening, 11 mm, 16 cm**

80-470-16



**Hohlsonde, gerade, 14,5 cm /
 Hollow probe, straight, 14.5 cm**

80-471-15

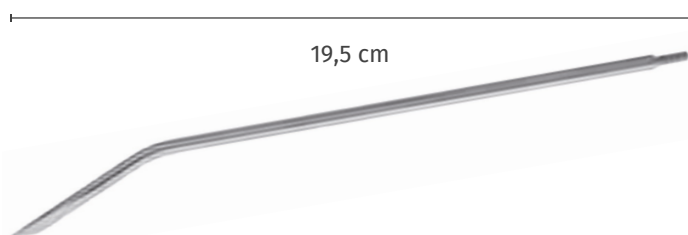

**Redon Führungsnadel,
 Lanzettspitze, leicht gebogen, 19,5 cm /
 Redon guide needle,
 lancet tip, slightly curved, 19.5 cm**

| Art.-Nr./No. | AD / OD (mm) |
|--------------|--------------|
| 80-472-25 | 2,5 |
| 80-472-35 | 3,5 |
| 80-472-40 | 4,0 |

08 Tracheotomie, Weichteile, Allgemeines

Tracheotomy, Neck Dissection, Miscellaneous

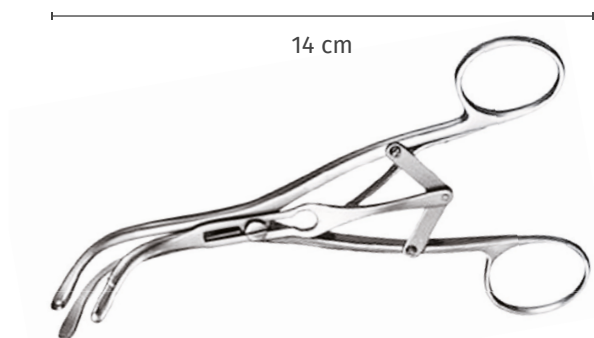

**Laborde Trachealdilatator,
3-armig, 14 cm /
Laborde tracheal dilator,
3 prongs, 14 cm**

80-478-14

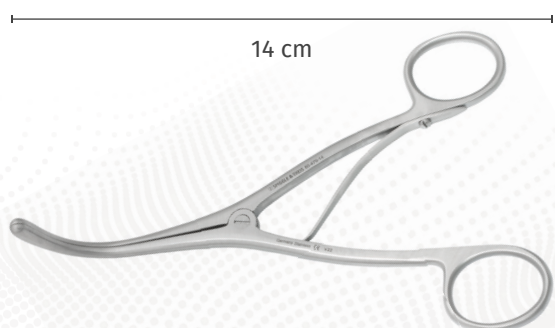

**Laborde Trachealdilatator,
2-armig, 14 cm /
Laborde tracheal dilator,
2 prongs, 14 cm**

80-479-14

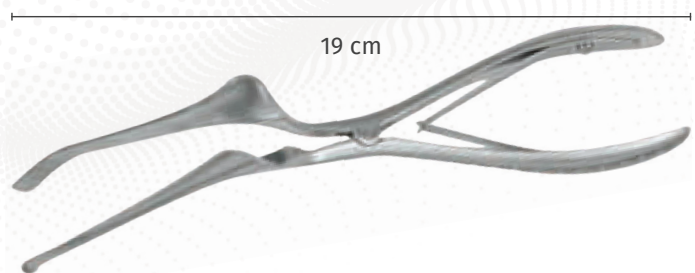

**Weerda Tracheal-Spekulum, 19 cm /
Weerda tracheal speculum, 19 cm**

80-482-19

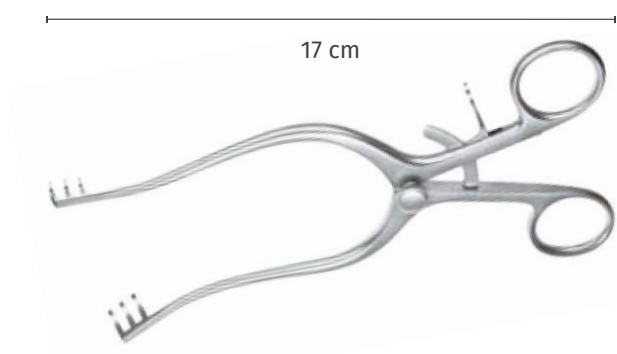

**Denecke Laryngofissur-Sperrer,
3:3 Zähne, 17 cm /
Denecke laryngectomy retractor,
3:3 teeth, 17 cm**

80-485-17



08 Tracheotomie, Weichteile, Allgemeines

Tracheotomy, Neck Dissection, Miscellaneous



Metallschale / Metal bowl

| Art.-Nr./ No. | | Durchmesser / Diameter (mm) | Höhe / Height (mm) | Fassungs- vermögen / Capacity (ml) |
|------------------|----|--------------------------------|--------------------------|--|
| 80-501-01 | B1 | Ø 40 | H=19 | 20 |
| 80-501-02 | B2 | Ø 60 | H=39 | 60 |
| 80-501-03 | B3 | Ø 85 | H=40 | 160 |
| 80-501-04 | B4 | Ø 110 | H=55 | 400 |



Medizinbecher, Edelstahl, graduiert /

Medicine cup, stainless steel, graduated

| Art.-Nr./ No. | | Durchmesser / Diameter (mm) | Höhe / Height (mm) | Fassungs- vermögen / Capacity (ml) |
|------------------|--|--------------------------------|--------------------------|--|
| 80-503-03 | | Ø 50 | H=25 | 30 |
| 80-504-05 | | Ø 53 | H=45 | 50 |



Lösungsschale, Edelstahl / Solution bowl, stainless steel

| Art.-Nr./ No. | | Durchmesser / Diameter (mm) | Höhe / Height (mm) | Fassungs- vermögen / Capacity (ml) |
|------------------|----|--------------------------------|--------------------------|--|
| 80-506-30 | B1 | Ø 100 | H=60 | 300 |
| 80-507-40 | B2 | Ø 120 | H=70 | 400 |
| 80-509-75 | B3 | Ø 150 | H=75 | 750 |



Tablettenschale, Edelstahl, Ø 65 mm, H=20 mm /

Tablet dish, stainless steel, Ø 65 mm, H=20 mm

80-512-00



Petrishale, Klarglas, mit Deckel / Petri dish, clear glass, with lid

| Art.-Nr./No. | AD / OD (mm) | Höhe / Height (mm) |
|--------------|--------------|--------------------|
| 80-515-06 | 60 | 15 |
| 80-515-08 | 80 | 15 |
| 80-515-10 | 150 | 20 |



Medikamenten-Schälchen, Glas, schwarz, mit Deckel, 4 x 4 cm /

Medication dish, glass, black, with lid, 4 x 4 cm

80-517-00

08 Tracheotomie, Weichteile, Allgemeines

Tracheotomy, Neck Dissection, Miscellaneous



80-519-00



80-519-01



80-519-02



80-519-03

**Medikamenten-Schälchen,
Dappenglas, farbig, Ø 3,2 cm /
Medication dish,
dappen-glass, colored, Ø 3.2 cm**

| Art.-Nr./No. | Farbe / Color |
|--------------|--------------------|
| 80-519-00 | kristall / crystal |
| 80-519-01 | grün / green |
| 80-519-02 | rosa / pink |
| 80-519-03 | topas / topaz |



**Porzellan-Schälchen, rund, mit Ausguss /
China bowl, round, with spout**

| Art.-Nr./No. | Durchmesser / Diameter (cm) |
|--------------|-----------------------------|
| 80-520-06 | Ø 8 |
| 80-520-08 | Ø 10 |



**Nierenschale, Edelstahl /
Kidney bowl, stainless steel**

| Art.-Nr./No. | Größe / Size (cm) |
|--------------|-------------------|
| 80-525-17 | 17,5 |
| 80-525-25 | 25,0 |



**Kornzangen-Behälter, Edelstahl/
Forceps holder, stainless steel**

| Art.-Nr./No. | Durchmesser / Diameter (cm) | Höhe / Height (cm) |
|--------------|-----------------------------|--------------------|
| 80-528-13 | Ø 5,0 | 13,5 |
| 80-528-18 | Ø 5,0 | 18,0 |
| 80-528-20 | Ø 9,5 | 20,0 |



**Kornzangen-Behälter,
Glas, Edelstahldeckel mit Ausschnitt, Ø 8 cm, Höhe 20 cm /
Forceps holder,
glass, stainless steel lid with opening, Ø 8 cm, height 20 cm**

80-530-20



08 Tracheotomie, Weichteile, Allgemeines

Tracheotomy, Neck Dissection, Miscellaneous



**Norm-Sterilisations-Container,
Normal-Boden, Ventil-Deckel mit Thermoloc,
Aluminium, Griff-Farbe nach Wahl /
Norm sterilization container,
unperforated bottom, valve lid with thermoloc,
aluminium, handle color of your choice**

| Art.-Nr./No. | Größe / Size (cm) |
|--------------|-------------------|
| 80-630-12 | 29,6 x 27,5 x 12 |
| 80-630-14 | 29,6 x 27,5 x 14 |
| 80-630-21 | 29,6 x 27,5 x 21 |
| 80-660-12 | 59,6 x 27,5 x 12 |
| 80-660-14 | 59,6 x 27,5 x 14 |
| 80-660-21 | 59,6 x 27,5 x 21 |

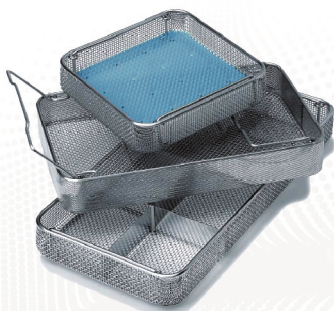

**Siebkorb, Edelstahl-Drahtgeflecht, Fallgriffe /
Basket, stainless-steel wire mesh, sliding handles**

| Art.-Nr./No. | Größe / Size (cm) |
|--------------|-------------------|
| 80-670-25 | 24,5 x 24,5 x 6 |
| 80-670-40 | 40,0 x 24,5 x 6 |
| 80-670-49 | 48,5 x 24,5 x 6 |



**Codier-Schild, 6 x 2 cm, 20 Zeichen /
Coding label, 6 x 2 cm, 20 characters**

| Art.-Nr./No. | Farbe / Color |
|--------------|-----------------|
| 80-680-01 | schwarz / black |
| 80-680-02 | rot / red |
| 80-680-03 | braun / brown |
| 80-680-04 | grün / green |
| 80-680-05 | gelb / yellow |
| 80-680-06 | lila / purple |
| 80-680-07 | blau / blue |

**Einweg-Container-Siegel, blau, 500 Stück/Box /
Container seal, disposable, blue, 500 pieces/box**

80-683-00

**Indikator-Klebe-Etikett, Lasche rechts, 1000 Stück/Box /
Adhesive indicator label, latch right side, 1000 pieces/box**

80-684-00

**Entsorgungsmarke, Edelstahl, zum Aufstecken, 2,5 x 3 cm,
inklusive Gravur bis zu 5 Zeichen /
Clip on coding clamp, stainless steel, 2,5 x 3 cm,
including engraving up to 5 characters**

80-685-00

**Klemmschild aus Edelstahl, hitzebeständig, 6 x 4 cm, 25 Stück/Box /
Label holder with clip, stainless steel, heat resistant, 6 x 4 cm,
25 pieces/box**

80-688-00

09 Weichteilchirurgie-Set 40-980-00

Neck dissection set 40-980-00

| Art.-Nr./ No. | Anz./ Pcs. | Art.-Nr./ No. | Anz./ Pcs. | Art.-Nr./ No. | Anz./ Pcs. | Art.-Nr./ No. | Anz./ Pcs. | Art.-Nr./ No. | Anz./ Pcs. | Art.-Nr./ No. | Anz./ Pcs. |
|------------------|---------------|------------------|---------------|------------------|---------------|------------------|---------------|------------------|---------------|------------------|---------------|
| 80-308-07 | 2 | 10-485-14 | 2 | 80-403-15 | 2 | 20-744-17 | 1 | 40-420-29 | 1 | 20-601-14 | 2 |
| 80-308-15 | 2 | 10-486-16 | 1 | 80-400-15 | 2 | 40-500-19 | 1 | 30-080-09 | 1 | 10-534-12 | 1 |
| 80-308-20 | 2 | 20-710-12 | 1 | 80-350-01 | 10 | 40-381-12 | 1 | 30-080-12 | 1 | 20-624-11 | 1 |
| 80-312-21 | 2 | 10-496-12 | 1 | 80-350-02 | 10 | 10-352-14 | 1 | 30-080-15 | 1 | 80-440-15 | 1 |
| 80-332-04 | 2 | 20-712-12 | 1 | 80-392-09 | 12 | 20-306-20 | 1 | 10-360-03 | 1 | 80-448-15 | 1 |
| 80-330-04 | 2 | 20-730-16 | 2 | 80-366-14 | 10 | 20-309-20 | 1 | 10-360-07 | 1 | 80-471-15 | 1 |
| 80-330-06 | 2 | 40-400-20 | 1 | 80-366-16 | 6 | 80-470-16 | 1 | 10-360-11 | 1 | 80-504-05 | 2 |
| 80-340-01 | 2 | 40-405-20 | 1 | 80-374-14 | 6 | 10-435-15 | 1 | 10-360-15 | 1 | 80-501-03 | 1 |
| 20-582-10 | 2 | 40-450-19 | 6 | 80-370-14 | 6 | 10-438-17 | 1 | 20-615-18 | 2 | 40-474-20 | 1 |
| 10-481-14 | 1 | 40-455-20 | 2 | 80-357-12 | 3 | 20-150-75 | 1 | 40-441-18 | 1 | 80-528-18 | 1 |
| 10-482-14 | 1 | 40-457-19 | 2 | 40-465-18 | 1 | 80-468-21 | 1 | 20-610-15 | 1 | 87-0130 | 2 |
| 10-484-14 | 2 | 40-462-18 | 2 | 20-740-15 | 1 | 20-252-03 | 1 | 20-615-15 | 2 | | |

09 Tonsillektomie/Adenotomie-Set 40-940-00

Tonsillectomy/Adenotomy set 40-940-00

| Art.-Nr./ No. | Anz./ Pcs. | Art.-Nr./ No. | Anz./ Pcs. | Art.-Nr./ No. | Anz./ Pcs. | Art.-Nr./ No. | Anz./ Pcs. |
|------------------|---------------|------------------|---------------|------------------|---------------|------------------|---------------|
| 40-300-02 | 1 | 40-553-02 | 1 | 40-355-28 | 1 | 40-465-18 | 1 |
| 40-305-00 | 1 | 40-555-13 | 1 | 40-359-27 | 1 | 80-106-19 | 1 |
| 40-318-01 | 1 | 40-200-00 | 1 | 40-381-15 | 1 | 80-017-50 | 1 |
| 40-318-02 | 1 | 40-200-01 | 1 | 40-390-21 | 1 | 80-392-09 | 6 |
| 40-318-03 | 1 | 40-200-02 | 1 | 40-406-20 | 1 | 80-504-05 | 2 |
| 40-318-04 | 1 | 40-200-03 | 1 | 40-420-29 | 1 | 80-501-03 | 1 |
| 40-500-19 | 1 | 40-220-02 | 1 | 40-430-19 | 1 | | |
| 40-520-00 | 1 | 40-225-00 | 1 | 20-615-18 | 1 | | |
| 40-524-02 | 1 | 20-254-03 | 1 | 40-450-19 | 1 | | |
| 40-524-06 | 1 | 40-230-21 | 1 | 40-457-19 | 1 | | |

09 Tränenweg-Chirurgie-Set 40-960-00

Lacrimal duct surgery set 40-960-00

| Art.-Nr./ No. | Anz./ Pcs. | Art.-Nr./ No. | Anz./ Pcs. | Art.-Nr./ No. | Anz./ Pcs. | Art.-Nr./ No. | Anz./ Pcs. |
|------------------|---------------|------------------|---------------|------------------|---------------|------------------|---------------|
| 20-100-01 | 1 | 10-300-40 | 1 | 20-740-15 | 1 | 30-101-25 | 1 |
| 20-150-55 | 1 | 40-606-06 | 1 | 10-481-14 | 1 | 30-101-30 | 1 |
| 20-150-90 | 1 | 40-606-08 | 1 | 10-484-14 | 1 | 80-106-19 | 1 |
| 20-151-75 | 1 | 40-600-12 | 1 | 20-730-16 | 1 | 80-017-50 | 1 |
| 20-307-18 | 1 | 40-615-01 | 1 | 20-680-16 | 1 | 80-392-09 | 6 |
| 30-200-01 | 1 | 40-615-02 | 1 | 20-690-01 | 1 | 80-504-05 | 2 |
| 30-469-20 | 1 | 40-615-03 | 1 | 30-304-25 | 1 | 80-501-03 | 1 |
| 30-320-01 | 1 | 40-610-40 | 1 | 30-720-16 | 1 | | |
| 20-215-02 | 1 | 40-610-20 | 1 | 30-722-16 | 1 | | |
| 20-225-02 | 1 | 40-610-12 | 1 | 30-102-25 | 1 | | |
| 10-300-30 | 1 | 40-610-34 | 1 | 30-102-30 | 1 | | |



Alphabetisches Inhaltsverzeichnis

| | | | | | |
|--|---------|---|---------|---|---------|
| Abraham Tonsillennmesser | 29 | Gross-Maier Kornzange | 29 | Orbita Gelenksperrer | 56 |
| Allis Gewebefasszange | 61 | Halsted Mosquito Klemme | 57 | Overholt-Geissdoerfer Tonsillenklemme | 28 |
| Ansatzrohr | 35 | Halteband für Negus Bruststützen | 17 | Parotis Spreizklemme | 57 |
| Antibesclagmittel | 8 | Halteband für Neutral-Elektrode | 41 | Pean Arterienklemme | 58 |
| Baby-Adson Präparierklemme | 59 | Hartmann Conchotom | 11 | Pelteson Kehlkopfwatteträger | 34 |
| Baby-Allis Gewebefasszange | 61 | Hartmann Zungenspatel | 31 | Petrischale mit Deckel | 66 |
| Baby-Roux Haken | 56 | Haslinger Gaumensegelhalter | 12 | Porzellanschälchen | 67 |
| Backhaus Tuchklemme | 60 | Henke Raspatorium | 20 | Präparierklemme oh. Sperre | 58 |
| Ballenger Fasszange | 22 | Henke Raspatorium/Dissektor | 21 | Raspatorium Würzburger Modell | 21 |
| Bangerter Tränenwegkanüle | 38 | Herberhold Zungenspatel | 16 | Redon Führungsnadel | 64 |
| Beckmann Ringmesser | 10 | HF-Chirurgie-Gerät | 40 | Reichert Epiglottis Halter | 34 |
| Bipolare Elektrode | 53 | High Grade flex. Nasopharyngoskop | 5 | Ring Zungenspatel | 16 |
| Bipolare Nadel Elektrode | 53 | Hofer Gaumenbogenhaken | 12 | Rochester-Pean Arterienklemme | 59 |
| Bipolare Pinzette, NON-STICK | 48 - 51 | Hohlsonde | 64 | Roeder Ligatur-Instrument | 19 |
| Bipolare Präparierschere | 45 | Huber Universal Handgriff | 35 | Roux Wundhaken | 56 |
| Bipolare Saugpinzette | 51 | Hurd Elevatorium/Retraktor | 21 | Ruedemann Dilatator | 39 |
| Bipolares Anschlusskabel | 43 - 44 | Hurd Unterbindungsnadel | 20 | Russel-Davis Zungenspatel | 15 |
| Birkett Tonsillenklemme | 27 | Hurd Raspatorium/Retraktor | 21 | Saugrohr | 24 |
| Blohmke Fasszange | 22 | Indikator-Klebe-Etikett | 68 | Seemann-Seiffert Mundsperrer | 18 |
| Boettcher Tonsillenschere | 25 | Injektionskanüle | 33 | Schädel Tuchklemme | 60 |
| Bowman Speichelgangsonde | 38 | Jatho Nasenrachenzange | 11 | Seiffert Hechtmaulansatz | 35 |
| Braun Hakenzange | 61 | Jennings Mundsperrer | 17 | Schmeden Conchotom | 12 |
| Brünings Löffelansatz | 35 | Jurasz Nasenrachenzange | 11 | Schnidt Tonsillenklemme | 27 |
| Brünings Tonsillennmesser | 29 | Kabel für Neutral-Elektrode | 42 | Schönborn Schilddrüsenhaken | 55 |
| Brünings Tonsillennschnürer | 19 | Kabierske Pulverbläser | 12 | Seiffert Tubensonde | 39 |
| Brünings Zungenspatel | 31 | Kehlkopf-Kanüle | 33 | Senn-Miller Wundhaken | 55 |
| Buchwald Zungenspatel | 31 | Kehlkopfspiegel | 32 | Siebkorb | 52, 68 |
| Codier-Schild | 68 | Kehlkopffzange | 35 | Silikonhalterung | 52 |
| Collin Zungenzange | 62 | Kette für Mundsperrer | 17 | Silikon-Schützer für Mundsperrer | 13 |
| Colver Fasszange | 22 | Kilian Kehlkopfwatteträger | 34 | Silikonformschlauch für Mundsperrer | 13 |
| Colver-Fischer Tonsillennmesser | 29 | Kilian Laryngofissur-Schere | 64 | Skalpelli-Griff | 30 |
| Container-Siegel | 68 | Knopfkannüle | 38 | Skalpelli-Klingen | 30 |
| Cooper Schere | 62 | Knotenführer | 20 | Sluder-Ballenger Tonsillotom | 18 |
| Crile Arterienklemme | 58 | Koagulations-Saugrohr | 46 | Speichelgang-Schere | 38 |
| Crile-Coller Arterienklemme | 59 | Kocher Arterienklemme | 58 | Speichelgang-Sonden-Set | 39 |
| Crile-Wood Nadelhalter | 28 | Kocher Führungssonde | 64 | St. Clair-Thomson Nasenrachenzange | 11 |
| Davis-Boyle Mundsperrer | 13 | Kocher-Langenbeck Wundhaken | 54 | Sternberg Lippenhaken | 54 |
| Davis-Boyle Mundsperrer für Kinder | 13 | Kornzangenbehälter | 67 | Stierlen Saugraspatorium | 21 |
| Davis-Boyle Zungenspatel | 14 | Kugelektrode | 44 | Stubbs Ringmesser | 10 |
| Davis-Meyer Mundsperrer | 13 | Laborde Trachealdilatator | 65 | Tablettenschale | 66 |
| Dean Tonsillenschere | 25 | Langenbeck Wundhaken | 54 | Tapia Adenoid Spatel | 31 |
| DeBakey Pinzette | 24 | Laryngoskop | 9 | Thilenius Tonsillen-Abszess-Zange | 29 |
| Denecke Laryngofissur-Sperrer | 65 | LED-Leuchtgriff | 8 | Toennis-Adson Tonsillenschere | 25 - 26 |
| Dingmann Mundsperrer | 16 | Leiste für Silikonhalterungen | 52 | Tonsillektomie/Adenotomie-Set | 69 |
| Dingmann Wangenhaken | 16 | Lister Verbandschere | 63 | Tonsillen-Pinzette | 23 |
| Dingmann Zahnhaken | 16 | Lösungsschale | 66 | Tonsillen-Schlingen | 19 |
| Dingmann Zungenspatel | 16 | Mayo-Stille-Schere | 63 | Trachealhäkchen | 56 |
| Draffin Mundsperrer-Aufhängung | 17 | Mclvor Mundsperrer | 13 | Tränenweg-Chirurgie-Set | 69 |
| Duval Gewebefasszange | 62 | Mclvor Zungenspatel | 14 | Tubal Instruments | 36 - 37 |
| Edna-Lorna Tuchklemme | 60 | Medikamentenschälchen | 66 | Tuchklemme | 61 |
| Einpedal-Fußschalter | 40 | Medizinbecher | 66 | Tyding Fasszange | 22 |
| Elektroden-Handgriff | 40 | Metallschale | 66 | Ueckermann Nottrokar | 64 |
| Endoskop | 5 | Metzenbaum Schere | 26 - 27 | Ultra-Stop Antibesclagmittel | 6 |
| Endoskop-Schutzhülse | 6 | Meuser bipolare Elektrode | 53 | Universal Drahtschneideschere | 19 |
| Endoskopie-Siebkorb | 7 | Middeldorf Wundhaken | 54 | Vogel Ringmesser | 10 |
| Entsorgungsmarke | 68 | Mikulicz Tonsillenklemme | 28 | Volkmann Wundhaken | 55 |
| Eves Tonsillennschnürer | 19 | Moritz-Schmidt Zungenspatel | 31 | Weerda Tracheal-Spekulum | 65 |
| Fadenhäkchen | 20 | Monopolare Elektroden | 44 | Weichteilchirurgie-Set | 69 |
| Fass-Zängchen | 23 | Monopolares Anschlusskabel | 42 | White Fasszange | 22 |
| Fein Kehlkopfwatteträger | 34 | Muck Tonsillenschere | 25 | Wilder Dilatator | 39 |
| Flexible Alligatorzange | 6 | Nadelelektrode | 44 | Yankauer Saugrohr | 24 |
| Flexible Löffelzange | 6 | Nager Gaumensegelhaken | 12 | Zoom Laryngoskop | 9 |
| Flexible Reinigungsbürste | 6 | Nager Unterbindungsnadel | 20 | Zungenspatel Mod. Würzburg | 15 |
| Flexibles Endoskop | 5 | Narkosebügel | 17 | | |
| Fraenkel Löffelansatz | 35 | Negus Bruststütze | 17 | | |
| Frenzel Zungenspatel | 31 | Negus Ringmesser | 10 | | |
| Gelenkkloben | 17 | Negus Tonsillenklemme | 27 | | |
| Good Tonsillenschere | 24 | Neutral-Elektrode | 41 | | |
| Good-Schweckendiek Tonsillenschere | 24 | Nierenschale | 67 | | |
| Griff für Kehlkopfspiegel | 33 | Norm-Sterilisations-Container | 69 | | |
| Gross Kornzange | 28 | Ochsner-Kocher Arterienklemme | 60 | | |

Alphabetical Index

| | | | | | |
|--|---------|---|---------|--|---------|
| Abraham tonsil knife..... | 29 | Flexible cup forceps | 6 | Orbital retractor | 56 |
| Adhesive indicator label..... | 68 | Flexible endoscope..... | 5 | Overholt-Geissdoerfer tonsil forceps | 28 |
| Anesthesia frame L-form..... | 17 | Fraenkel tip..... | 35 | Parotis spreading clamp | 57 |
| Allis tissue holding forceps..... | 61 | Frenzel tongue depressor..... | 31 | Pean artery forceps..... | 58 |
| Anti-fog..... | 8 | Good tonsil scissors..... | 24 | Pelteson laryngeal cotton carrier..... | 34 |
| Artery forceps w/o ratchet..... | 58 | Good-Schweckendiek tonsil scissors..... | 24 | Petri Bowl..... | 66 |
| Baby-Adson artery forceps..... | 59 | Grasper..... | 43 | Raspatory Würzburg type | 21 |
| Baby-Allis tissue holding forceps..... | 61 | Gross sponge forceps..... | 28 | Redon guide needle..... | 64 |
| Baby-Roux retractor..... | 56 | Gross-Maier sponge forceps..... | 29 | Reichert epiglottis holder..... | 34 |
| Backhaus towel clamp..... | 60 | Halsted mosquito artery forceps..... | 57 | Ring tongue depressor..... | 16 |
| Ball electrode..... | 44 | Handle for laryngeal mirrors..... | 33 | Rotation clamp..... | 17 |
| Ballenger tonsil forceps..... | 23 | Hartmann cutting forceps..... | 11 | Rochester-Pean artery forceps..... | 59 |
| Band for chest supports..... | 18 | Hartmann tongue depressor..... | 31 | Roeder ligature instrument | 19 |
| Bangerter lacrimal duct cannula..... | 38 | Haslinger uvula retractor..... | 12 | Roux retractor..... | 56 |
| Basket..... | 52, 68 | Henke raspatory..... | 20 | Ruedemann dilator for infants..... | 39 |
| Bar for silicone holders..... | 52 | Henke raspatory / dissector..... | 21 | Russel-Long tongue depressor..... | 15 |
| Beckmann adenoid curette..... | 10 | Herberhold tongue depressor..... | 16 | Salivary duct probe set..... | 39 |
| Bipolar connecting cable..... | 43 - 44 | HF surgical unit..... | 40 | Salivary duct scissors..... | 38 |
| Bipolar dissecting scissors..... | 45 | High Grade flexible endoscope..... | 5 | Scalpel blades..... | 30 |
| Bipolar electrode..... | 53 | Hofer palate retractor..... | 12 | Scalpel handle..... | 30 |
| Bipolar forceps..... | 48 - 51 | Holding band for neutral electrode..... | 41 | Solution bowl..... | 66 |
| Bipolar needle electrode..... | 53 | Hollow probe..... | 64 | Schädel towel clamp..... | 60 |
| Bipolar suction forceps..... | 51 | Huber Universal handle..... | 35 | Schmeden cutting forceps..... | 12 |
| Birkett tonsil forceps..... | 27 | Hurd dissector/retractor..... | 21 | Schmidt tonsil forceps..... | 27 |
| Blohmke tonsil forceps..... | 22 | Hurd elevator/retractor..... | 21 | Schönborn thyroid retractor..... | 55 |
| Boettcher tonsil scissors..... | 25 | Hurd tonsil suture needle..... | 20 | Seemann-Seiffert mouth gag..... | 18 |
| Bowman salivary duct probe..... | 38 | Injection needle..... | 33 | Seiffert alligator tip..... | 35 |
| Braun hook forceps..... | 61 | Instrument tray..... | 44 | Seiffert eustachian tube probe..... | 39 |
| Brünings tip..... | 35 | Jatho epipharyngeal forceps..... | 11 | Senn-Miller retractor..... | 55 |
| Brünings tongue depressor..... | 31 | Jennings mouth gag..... | 17 | Silicone holder..... | 52 |
| Brünings tonsil knife..... | 29 | Jurasz adenoid forceps..... | 11 | Silicone insert for mouth gags..... | 13 |
| Brünings tonsil snare..... | 19 | Kabierske powder blower..... | 12 | Silicone neutral electrode..... | 42 |
| Buchwald tongue depressor..... | 31 | Kidney bowl..... | 67 | Silicone tubing, slit..... | 13 |
| Cable for single use neutral electrode..... | 42 | Kilian laryngeal cotton carrier..... | 34 | Single pedal footswitch..... | 40 |
| Cannula, ball-ended..... | 38 | Kilian laryngectomy scissors..... | 64 | Sluder-Ballenger tonsillotomy + blade..... | 18 |
| Chain for mouth gags..... | 17 | Knot tier..... | 20 | St. Clair-Thomson adenoid forceps..... | 11 |
| China bowl..... | 67 | Kocher artery forceps..... | 58 | Sternberg lip retractor..... | 54 |
| Clip on coding clamp..... | 68 | Kocher director..... | 64 | Stierlen suction-raspatory..... | 21 |
| Coagulation suction tube..... | 46 | Kocher-Langenbeck retractor..... | 54 | Stubbs adenoid curette..... | 10 |
| Coding label..... | 68 | Laborde tracheal dilatator..... | 65 | Suction tube..... | 24 |
| Collin tongue forceps..... | 62 | Lacrimal duct surgery set..... | 69 | Suture hook..... | 20 |
| Colver tonsil forceps..... | 22 | Langenbeck retractor..... | 54 | Tablet dish..... | 66 |
| Colver-Fischer tonsil knife..... | 29 | Laryngeal cannula..... | 33 | Tapia adenoid spatula..... | 31 |
| Connecting tube..... | 35 | Laryngeal forceps..... | 35 | Thilenius tonsil abscess forceps..... | 29 |
| Container seal..... | 68 | Laryngeal mirror..... | 32 | Toennis-Adson tonsil scissor..... | 25 - 26 |
| Cooper scissors..... | 62 | Laryngoscope..... | 9 | Tongue depressor, Würzburg model..... | 15 |
| Crile artery forceps..... | 58 | LED light handle..... | 8 | Tonsil dissecting forceps..... | 23 |
| Crile-Coller artery forceps..... | 59 | Lister bandage scissors..... | 63 | Tonsil dressing forceps..... | 23 |
| Crile-Wood needle holder..... | 28 | Mayo-Stille scissors..... | 63 | Tonsil wire loops..... | 19 |
| Davis-Boyle mouth gag..... | 13 | Mclvor mouth gag..... | 13 | Tonsillectomy/Adenotomy set..... | 69 |
| Davis-Boyle tongue depressor..... | 14 | Mclvor tongue depressor..... | 14 | Towel clamp..... | 61 |
| Davis-Meyer mouth gag..... | 13 | Medication cup..... | 66 | Trachea hook..... | 56 |
| Dean tonsil scissors..... | 25 | Metal Bowl..... | 66 | Tubalstruments..... | 36 - 37 |
| DeBakey dressing forceps..... | 24 | Metzenbaum scissors..... | 26 - 27 | Tyding tonsil forceps..... | 22 |
| Denecke laryngectomy retractor..... | 65 | Meuser bipolar electrode..... | 53 | Ueckermann tracheotomy trocar..... | 64 |
| Dingmann cheek retractors..... | 16 | Middeldorp antrum retractor..... | 54 | Ultra-Stop antifog solution..... | 6 |
| Dingmann mouth gag..... | 16 | Mikulicz tonsil forceps..... | 28 | Universal wire cutting scissors..... | 20 |
| Dingmann tooth hooks..... | 16 | Moritz-Schmidt tongue depressor..... | 31 | Vogel adenoid curette..... | 10 |
| Dingmann tongue depressor..... | 16 | Monopolar connecting cable..... | 42 | Volkman retractor..... | 55 |
| Draffin bipod suspension for mouth gags..... | 17 | Monopolar electrodes..... | 44 | Weerda tracheal speculum..... | 65 |
| Duval tissue forceps..... | 62 | Muck tonsil scissors..... | 25 | White tonsil forceps..... | 22 |
| Edna-Lorna towel clamp..... | 60 | Nager pillar retractor..... | 12 | Wilder dilatator..... | 39 |
| Electrode handle..... | 40 | Nager tonsil suture needle..... | 20 | Yankauer suction tube..... | 24 |
| Endoscope..... | 7 | Neck dissection set..... | 69 | Zoom laryngoscope..... | 9 |
| Endoscope protective sleeve..... | 6 | Needle electrode..... | 44 | | |
| Endoscopy container..... | 7 | Negus adenoid curette..... | 10 | | |
| Eves tonsil snare..... | 19 | Negus chest support..... | 17 | | |
| Fein laryngeal cotton carrier..... | 34 | Negus tonsil forceps..... | 27 | | |
| Forceps holder..... | 67 | Norm sterilization container..... | 68 | | |
| Flexible alligator forceps..... | 6 | Ochsner-Kocher artery forceps..... | 60 | | |
| Flexible cleaning brush..... | 6 | One pedal foot-switch..... | 46 | | |



Numerisches Inhaltsverzeichnis

Numeric Content

| | | | | | |
|------------------|------------------|------------------|------------------|------------------|------------------|
| 10-155-00.....12 | 40-203-03.....10 | 40-318-02.....15 | 40-386-23.....21 | 40-522-09.....32 | 40-940-00.....69 |
| 10-155-01.....12 | 40-203-04.....10 | 40-318-03.....15 | 40-388-21.....21 | 40-522-10.....32 | 40-960-00.....69 |
| 10-155-02.....12 | 40-206-00.....10 | 40-318-04.....15 | 40-390-21.....22 | 40-522-20.....32 | 40-980-00.....69 |
| 10-303-18.....24 | 40-206-01.....10 | 40-318-05.....15 | 40-392-19.....22 | 40-522-30.....32 | 50-365-27.....53 |
| 10-360-03.....30 | 40-206-02.....10 | 40-320-01.....15 | 40-394-18.....22 | 40-524-00.....32 | 70-211-00.....8 |
| 10-360-04.....30 | 40-206-03.....10 | 40-320-02.....15 | 40-394-23.....22 | 40-524-01.....32 | 70-211-01.....8 |
| 10-360-07.....30 | 40-211-07.....10 | 40-320-03.....15 | 40-395-22.....22 | 40-524-02.....32 | 70-211-10.....8 |
| 10-360-10.....30 | 40-220-01.....11 | 40-320-04.....15 | 40-397-21.....22 | 40-524-03.....32 | 70-211-20.....8 |
| 10-360-11.....30 | 40-220-02.....11 | 40-320-05.....15 | 40-400-20.....23 | 40-524-04.....32 | 70-211-30.....8 |
| 10-360-15.....30 | 40-225-00.....11 | 40-322-02.....16 | 40-401-20.....23 | 40-524-05.....32 | 70-211-40.....8 |
| 10-360-33.....30 | 40-230-21.....12 | 40-322-03.....16 | 40-402-20.....23 | 40-524-06.....32 | 70-211-50.....8 |
| 10-729-18.....39 | 40-232-23.....12 | 40-322-04.....16 | 40-405-20.....23 | 40-524-07.....32 | 80-000-80.....40 |
| 10-745-12.....19 | 40-235-17.....12 | 40-322-05.....16 | 40-406-20.....23 | 40-524-08.....32 | 80-003-01.....40 |
| 20-252-01.....11 | 40-240-01.....36 | 40-323-02.....16 | 40-407-20.....23 | 40-524-09.....32 | 80-003-02.....40 |
| 20-252-02.....11 | 40-240-02.....36 | 40-323-03.....16 | 40-408-20.....23 | 40-524-10.....32 | 80-004-00.....40 |
| 20-252-03.....11 | 40-241-01.....36 | 40-323-04.....16 | 40-410-20.....24 | 40-524-20.....32 | 80-005-00.....40 |
| 20-252-04.....11 | 40-241-02.....36 | 40-323-05.....16 | 40-412-20.....24 | 40-524-30.....32 | 80-006-00.....40 |
| 20-254-00.....12 | 40-242-01.....36 | 40-325-01.....16 | 40-420-29.....24 | 40-525-00.....33 | 80-007-45.....42 |
| 20-254-01.....12 | 40-242-02.....36 | 40-325-02.....16 | 40-421-21.....24 | 40-525-01.....33 | 80-008-45.....42 |
| 20-254-02.....12 | 40-243-00.....36 | 40-325-03.....16 | 40-430-19.....24 | 40-525-02.....33 | 80-009-45.....42 |
| 20-254-03.....12 | 40-244-01.....37 | 40-325-04.....16 | 40-431-19.....24 | 40-525-03.....33 | 80-010-40.....41 |
| 20-612-18.....26 | 40-244-02.....37 | 40-327-00.....16 | 40-433-18.....25 | 40-525-04.....33 | 80-011-40.....41 |
| 20-612-20.....26 | 40-245-01.....37 | 40-327-01.....16 | 40-434-18.....25 | 40-525-05.....33 | 80-012-75.....41 |
| 20-613-18.....26 | 40-245-02.....37 | 40-327-02.....16 | 40-436-17.....25 | 40-525-06.....33 | 80-013-40.....41 |
| 20-613-20.....26 | 40-300-01.....13 | 40-327-03.....16 | 40-438-18.....25 | 40-525-07.....33 | 80-014-45.....42 |
| 20-614-18.....26 | 40-300-02.....13 | 40-327-98.....16 | 40-440-18.....25 | 40-525-08.....33 | 80-015-45.....42 |
| 20-614-20.....26 | 40-302-01.....13 | 40-327-99.....16 | 40-441-18.....26 | 40-525-09.....33 | 80-016-50.....43 |
| 20-615-18.....26 | 40-302-02.....13 | 40-330-09.....17 | 40-442-18.....26 | 40-525-10.....33 | 80-017-30.....43 |
| 20-615-20.....26 | 40-302-03.....13 | 40-330-14.....17 | 40-450-19.....27 | 40-525-20.....33 | 80-017-50.....43 |
| 20-616-18.....27 | 40-302-04.....13 | 40-330-99.....17 | 40-451-19.....27 | 40-525-30.....33 | 80-018-30.....43 |
| 30-160-01.....6 | 40-303-00.....13 | 40-335-00.....17 | 40-454-20.....27 | 40-553-01.....33 | 80-018-50.....43 |
| 30-160-02.....6 | 40-305-00.....13 | 40-335-01.....17 | 40-455-20.....27 | 40-553-02.....33 | 80-019-30.....43 |
| 30-160-03.....6 | 40-305-10.....13 | 40-337-00.....17 | 40-457-19.....27 | 40-555-13.....33 | 80-019-50.....43 |
| 30-160-04.....8 | 40-305-99.....13 | 40-340-09.....17 | 40-458-19.....27 | 40-558-24.....34 | 80-020-30.....43 |
| 30-160-05.....8 | 40-310-01.....14 | 40-340-11.....17 | 40-460-19.....28 | 40-560-22.....34 | 80-020-50.....43 |
| 30-170-28.....5 | 40-310-02.....14 | 40-340-13.....17 | 40-462-18.....28 | 40-561-28.....34 | 80-022-30.....44 |
| 30-170-36.....5 | 40-310-03.....14 | 40-340-15.....17 | 40-465-18.....28 | 40-570-01.....34 | 80-022-50.....44 |
| 30-171-40.....5 | 40-311-01.....14 | 40-341-11.....18 | 40-465-20.....28 | 40-570-02.....34 | 80-045-15.....42 |
| 30-172-40.....6 | 40-311-02.....14 | 40-341-13.....18 | 40-465-23.....28 | 40-572-01.....35 | 80-046-45.....42 |
| 30-173-40.....6 | 40-311-03.....14 | 40-342-09.....18 | 40-474-20.....28 | 40-572-02.....35 | 80-050-10.....44 |
| 30-174-40.....6 | 40-311-04.....14 | 40-342-11.....18 | 40-475-26.....29 | 40-575-00.....35 | 80-051-10.....44 |
| 30-182-21.....6 | 40-311-15.....14 | 40-342-13.....18 | 40-477-20.....29 | 40-576-20.....35 | 80-052-01.....44 |
| 30-700-01.....17 | 40-311-25.....14 | 40-343-00.....18 | 40-480-22.....29 | 40-578-00.....35 | 80-052-02.....44 |
| 40-100-70.....8 | 40-311-35.....14 | 40-350-00.....18 | 40-482-23.....29 | 40-579-00.....35 | 80-052-03.....44 |
| 40-100-90.....8 | 40-312-01.....14 | 40-350-01.....18 | 40-484-22.....29 | 40-580-00.....35 | 80-052-04.....44 |
| 40-103-70.....9 | 40-312-02.....14 | 40-350-02.....18 | 40-500-19.....31 | 40-581-00.....35 | 80-052-05.....44 |
| 40-103-90.....9 | 40-312-03.....14 | 40-350-03.....18 | 40-502-17.....31 | 40-600-12.....38 | 80-060-10.....46 |
| 40-105-70.....9 | 40-312-04.....14 | 40-350-10.....18 | 40-504-15.....31 | 40-601-12.....38 | 80-061-26.....46 |
| 40-105-90.....9 | 40-312-05.....14 | 40-355-28.....19 | 40-506-19.....31 | 40-604-08.....38 | 80-062-26.....46 |
| 40-107-70.....9 | 40-313-01.....14 | 40-357-28.....19 | 40-508-18.....31 | 40-604-10.....38 | 80-063-30.....46 |
| 40-110-30.....7 | 40-313-02.....14 | 40-359-27.....19 | 40-510-01.....31 | 40-604-12.....38 | 80-064-13.....46 |
| 40-110-70.....7 | 40-313-03.....15 | 40-360-50.....19 | 40-510-02.....31 | 40-606-06.....38 | 80-080-13.....45 |
| 40-112-00.....7 | 40-313-04.....15 | 40-365-01.....20 | 40-510-03.....31 | 40-606-08.....38 | 80-081-14.....45 |
| 40-112-30.....7 | 40-313-05.....15 | 40-365-02.....20 | 40-520-00.....33 | 40-607-06.....38 | 80-082-17.....45 |
| 40-112-70.....7 | 40-315-01.....15 | 40-367-24.....20 | 40-522-00.....32 | 40-610-12.....38 | 80-083-18.....45 |
| 40-200-00.....10 | 40-315-02.....15 | 40-368-21.....20 | 40-522-01.....32 | 40-610-20.....38 | 80-100-16.....49 |
| 40-200-01.....10 | 40-315-03.....15 | 40-369-21.....20 | 40-522-02.....32 | 40-610-34.....38 | 80-100-19.....49 |
| 40-200-02.....10 | 40-315-04.....15 | 40-370-21.....20 | 40-522-03.....32 | 40-610-40.....38 | 80-101-16.....49 |
| 40-200-03.....10 | 40-315-05.....15 | 40-381-12.....21 | 40-522-04.....32 | 40-613-08.....39 | 80-101-19.....49 |
| 40-200-04.....10 | 40-316-01.....15 | 40-381-15.....21 | 40-522-05.....32 | 40-615-01.....39 | 80-101-22.....49 |
| 40-203-00.....10 | 40-316-02.....15 | 40-382-24.....20 | 40-522-06.....32 | 40-615-02.....39 | 80-103-16.....49 |
| 40-203-01.....10 | 40-316-03.....15 | 40-384-24.....21 | 40-522-07.....32 | 40-615-03.....39 | 80-103-19.....49 |
| 40-203-02.....10 | 40-318-01.....15 | 40-385-23.....21 | 40-522-08.....32 | 40-617-00.....39 | 80-105-16.....49 |



Numerisches Inhaltsverzeichnis

Numeric Content

| | | | |
|------------------|------------------|------------------|------------------|
| 80-105-19.....49 | 80-306-17.....54 | 80-372-14.....58 | 80-504-05.....66 |
| 80-106-16.....49 | 80-306-22.....54 | 80-372-16.....58 | 80-506-30.....66 |
| 80-106-19.....49 | 80-306-30.....54 | 80-374-14.....58 | 80-507-40.....66 |
| 80-106-25.....49 | 80-308-06.....54 | 80-375-14.....58 | 80-509-75.....66 |
| 80-107-16.....49 | 80-308-07.....54 | 80-376-16.....59 | 80-512-00.....66 |
| 80-107-19.....49 | 80-308-10.....54 | 80-380-18.....59 | 80-515-06.....66 |
| 80-109-16.....49 | 80-308-15.....54 | 80-382-18.....59 | 80-515-08.....66 |
| 80-110-16.....49 | 80-308-20.....54 | 80-382-20.....59 | 80-515-10.....66 |
| 80-110-19.....49 | 80-309-11.....55 | 80-383-18.....59 | 80-517-00.....66 |
| 80-111-16.....49 | 80-309-14.....55 | 80-383-20.....59 | 80-519-00.....67 |
| 80-111-19.....49 | 80-309-16.....55 | 80-383-22.....59 | 80-519-01.....67 |
| 80-112-16.....49 | 80-309-41.....55 | 80-385-18.....59 | 80-519-02.....67 |
| 80-112-19.....49 | 80-309-51.....55 | 80-385-20.....60 | 80-519-03.....67 |
| 80-113-19.....49 | 80-310-01.....56 | 80-387-18.....60 | 80-520-06.....67 |
| 80-113-23.....49 | 80-310-02.....56 | 80-387-20.....60 | 80-520-08.....67 |
| 80-114-19.....49 | 80-312-21.....56 | 80-390-09.....60 | 80-525-17.....67 |
| 80-115-19.....49 | 80-314-16.....56 | 80-392-09.....60 | 80-525-25.....67 |
| 80-116-19.....49 | 80-315-16.....56 | 80-392-11.....60 | 80-528-13.....67 |
| 80-117-19.....50 | 80-317-00.....56 | 80-392-13.....60 | 80-528-18.....67 |
| 80-118-19.....50 | 80-318-01.....56 | 80-394-09.....60 | 80-528-20.....67 |
| 80-119-19.....50 | 80-318-02.....56 | 80-394-13.....60 | 80-530-20.....67 |
| 80-120-19.....50 | 80-318-03.....56 | 80-397-12.....61 | 80-621-05.....7 |
| 80-121-18.....50 | 80-330-01.....55 | 80-397-14.....61 | 80-622-56.....7 |
| 80-122-18.....51 | 80-330-02.....55 | 80-400-15.....61 | 80-623-22.....7 |
| 80-123-16.....50 | 80-330-03.....55 | 80-401-14.....61 | 80-630-12.....68 |
| 80-125-03.....51 | 80-330-04.....55 | 80-403-15.....61 | 80-660-14.....68 |
| 80-125-07.....51 | 80-330-06.....55 | 80-405-20.....62 | 80-660-21.....68 |
| 80-125-12.....51 | 80-332-01.....55 | 80-407-16.....62 | 80-670-25.....68 |
| 80-125-20.....51 | 80-332-02.....55 | 80-440-13.....62 | 80-670-40.....68 |
| 80-127-03.....50 | 80-332-03.....55 | 80-440-15.....62 | 80-670-49.....68 |
| 80-127-07.....50 | 80-332-04.....55 | 80-442-13.....62 | 80-680-01.....68 |
| 80-127-10.....50 | 80-332-06.....55 | 80-442-15.....62 | 80-680-02.....68 |
| 80-127-20.....50 | 80-340-01.....56 | 80-444-13.....62 | 80-680-03.....68 |
| 80-128-03.....51 | 80-340-02.....56 | 80-444-15.....62 | 80-680-04.....68 |
| 80-128-07.....51 | 80-340-03.....56 | 80-446-13.....63 | 80-680-05.....68 |
| 80-128-12.....51 | 80-340-04.....56 | 80-446-15.....63 | 80-680-06.....68 |
| 80-128-20.....51 | 80-342-01.....56 | 80-448-13.....63 | 80-680-07.....68 |
| 80-129-12.....50 | 80-342-02.....56 | 80-448-15.....63 | 80-683-00.....68 |
| 80-150-17.....48 | 80-342-03.....56 | 80-450-13.....63 | 80-684-00.....68 |
| 80-150-20.....48 | 80-342-04.....56 | 80-450-15.....63 | 80-685-00.....68 |
| 80-150-23.....48 | 80-350-01.....57 | 80-455-15.....63 | 80-688-00.....68 |
| 80-152-17.....48 | 80-350-02.....57 | 80-457-15.....63 | 80-691-01.....7 |
| 80-152-20.....48 | 80-350-03.....57 | 80-459-15.....63 | 80-692-01.....7 |
| 80-152-23.....48 | 80-350-04.....57 | 80-460-15.....63 | |
| 80-156-20.....48 | 80-352-01.....57 | 80-465-15.....63 | |
| 80-156-23.....48 | 80-352-02.....57 | 80-465-18.....63 | |
| 80-158-20.....48 | 80-352-03.....57 | 80-465-20.....63 | |
| 80-158-23.....48 | 80-352-04.....57 | 80-468-21.....64 | |
| 80-183-14.....51 | 80-354-01.....57 | 80-470-16.....64 | |
| 80-183-20.....51 | 80-354-02.....57 | 80-471-15.....64 | |
| 80-184-22.....53 | 80-354-03.....57 | 80-472-25.....64 | |
| 80-185-22.....53 | 80-354-04.....57 | 80-472-35.....64 | |
| 80-190-08.....53 | 80-356-12.....58 | 80-472-40.....64 | |
| 80-190-11.....53 | 80-357-12.....58 | 80-478-14.....65 | |
| 80-191-11.....53 | 80-359-14.....58 | 80-479-14.....65 | |
| 80-260-34.....52 | 80-360-14.....58 | 80-480-09.....64 | |
| 80-270-24.....52 | 80-361-14.....58 | 80-482-19.....65 | |
| 80-272-24.....52 | 80-365-14.....58 | 80-485-17.....65 | |
| 80-275-24.....52 | 80-365-16.....58 | 80-501-01.....66 | |
| 80-280-00.....52 | 80-366-14.....58 | 80-501-02.....66 | |
| 80-302-12.....54 | 80-366-16.....58 | 80-501-03.....66 | |
| 80-302-14.....54 | 80-370-14.....58 | 80-501-04.....66 | |
| 80-302-16.....54 | 80-370-16.....58 | 80-503-03.....66 | |



Umrechnungstabelle - Ch/Fr - mm - inch

Conversion table - Ch/Fr - mm - inch

| Charrière (CH) French (F) | mm | Inch |
|------------------------------|-------|-------|
| 1 | 0,33 | 0,013 |
| 2 | 0,67 | 0,025 |
| 3 | 1,00 | 0,039 |
| 4 | 1,33 | 0,051 |
| 5 | 1,67 | 0,065 |
| 6 | 2,00 | 0,079 |
| 7 | 2,33 | 0,092 |
| 8 | 2,67 | 0,105 |
| 9 | 3,00 | 0,118 |
| 10 | 3,33 | 0,131 |
| 11 | 3,67 | 0,144 |
| 12 | 4,00 | 0,156 |
| 13 | 4,33 | 0,170 |
| 14 | 4,67 | 0,184 |
| 15 | 5,00 | 0,197 |
| 16 | 5,33 | 0,210 |
| 17 | 5,67 | 0,223 |
| 18 | 6,00 | 0,237 |
| 19 | 6,33 | 0,249 |
| 20 | 6,67 | 0,263 |
| 21 | 7,00 | 0,276 |
| 22 | 7,33 | 0,288 |
| 23 | 7,67 | 0,302 |
| 24 | 8,00 | 0,315 |
| 25 | 8,33 | 0,328 |
| 26 | 8,67 | 0,341 |
| 27 | 9,00 | 0,354 |
| 28 | 9,33 | 0,367 |
| 29 | 9,67 | 0,380 |
| 31 | 10,23 | 0,407 |
| 32 | 10,67 | 0,420 |
| 34 | 11,33 | 0,446 |
| 36 | 12,00 | 0,472 |
| 38 | 12,67 | 0,494 |
| 40 | 13,33 | 0,520 |
| 45 | 15,00 | 0,591 |



© 2018 by SPIGGLE & THEIS Medizintechnik GmbH

Änderungen und Irrtümer – einschließlich Bilder - vorbehalten.
Produktsortiment kann pro Land abweichen.

Modifications and errors – including pictures – reserved.
Product range might vary per country.



Burghof 14 · 51491 Overath · Germany

Phone: +49 2206 90 81 - 0

Fax: +49 2206 90 81 - 13

info@spiggle-theis.com

www.spiggle-theis.com