

# MAQUET

## MOBILE OPERATING TABLES ALPHACLASSIC / BETACLASSIC

SURGICAL WORKPLACES



## ALPHACLASSIC · BETACLASSIC

Cost effectiveness at the quality level of MAQUET:  
The Classic models are user friendly and suitable for  
all surgical specialities.





## Key features and benefits

1. Function: BETACLASSIC with multi-part table top, optional with longitudinal shift or body elevator
2. Comfort: ALPHACLASSIC, now with IR remote control, corded hand control, and override-control panel
3. The BETACLASSIC is designed with ergonomically positioned user controls and a pedal operated function selector switch



## ALPHACLASSIC

The new ALPHACLASSIC represents cost effectiveness and the unique operational comfort provided by MAQUET products. The options of IR remote control, corded hand control, and footswitch make patient positioning much easier and quicker. The override panel on the column provides additional safety in the case of the loss or damage to a hand control. The smooth electro/hydraulic power unit reduces manual handling by staff in the operating room.

## BETACLASSIC

Manually operated hydraulic power unit and ergonomically designed controls are standard on the robust BETACLASSIC. The pedal operated function selector switch enables precise adjustment of the table top position by a few swift pumps of the foot pedal.

The proven design ensures excellent table stability and unrestricted patient access for the surgical team.



## ALPHACLASSIC · BETACLASSIC

Patient positioning with comfort: The ALPHACLASSIC meets all user requirements in its class. The combination of suitability for all surgical disciplines, operational comfort and safety makes this table a reliable and easy to use universal product.





### Comfort and Safety

1. ALPHACLASSIC: the convenient design of the base and optional longitudinal shift provides unrestricted access to the patient
2. SFC-padding provides outstanding comfort for the patient lying on it as well as a high standard of safety
3. Safe positioning and adjustment due to optimal covering of moving joints



### Universal patient and user comfort with ease of use

MAQUET designed the Classic Models for increased flexibility to meet different surgical requirements.

Different models offering high flexibility and SFC padded universal table tops provide a universal flexible table at a cost effective price.

SFC pads (Special Foam Core) used throughout the MAQUET range with multi-layer construction and memory have long been appreciated by customers for their quality and resistance to wear and tear.

The table top that can be adjusted to a very low height to suit the positions of seated clinicians such as in ophthalmology. The back and footplates are gas spring adjusted offering easy and smooth control.

## EXAMPLES OF PATIENT POSITIONING

High flexibility makes the Classic model universal purpose OR tables ideal for surgery and examination.

### General surgery

With comfort and ease the OR table can be adjusted to the Flex-position.

Designed in conjunction with users, the table base provides the surgeon uninhibited access to the patient. The adjustment possibilities of the leg plates provide excellent access for minimal invasive surgery whilst providing stable support of the legs. The longitudinal shift option offers optimal access when using imaging equipment such as a C-arm.







## Mastering all situations

1. Lateral positioning e.g. for heart-thorax-vascular surgery with an arm support, and double jointed head plate – with the table top in the Flex-position
2. Patient positioning for minimal invasive surgery, with good access and stability
3. Longitudinal shift of the table top towards the head for optimal access with the image intensifier
4. Lithotomy positioning for urology – using a seat plate extension and TUR set  
Leg supports feature comfortable padding and one-hand adjustment
5. Lithotomy positioning with “Goepel” leg supports

## Urology, Gynaecology

Leg plates that can easily be removed and the user-friendly table base provide unrestricted access for gynaecology procedures. The leg supports can be adjusted quickly and easily.

The seat plate extension with guide rail option for the TUR set offers further room for access using image intensifiers for the entire urology and genital sections.



## EXAMPLES OF PATIENT POSITIONING

Stability and Flexibility: ALPHACLASSIC and BETACLASSIC are suitable for more complex patient positioning.

### Neurological surgery, Ophthalmology

The high stability of the Classic models makes the table ideal for neurosurgery. The design and flexibility of the tabletop and base offer first-class working conditions for the surgeon treating patients that may be positioned either flat or sitting.

Additionally, the Classic models of MAQUET offers excellent user ergonomics as the tabletop can be adjusted to an extremely low position. This enables comfortable working for the sitting surgeon e.g. in the fields of ophthalmology, otolaryngology, or oral and maxillofacial surgery.

The extensive product range is complemented by a comprehensive unique selection of accessories.







## Flexible solutions for special requirements

1. Stable sitting patient position for neurological surgery with use of a skull clamp
2. Supine position with stable head fixation
3. Ophthalmology position. Low height of the tabletop, fixation of adapter piece with handle screws  
Comfortable position with a horseshoe headrest
4. Prone position for dorsal access – table top with longitudinal shift in head direction
5. Sitting patient position for trauma/orthopaedic surgery with 3-segment shoulder plate  
Ideal positioning and support of the head using a U-shaped helmet

## Trauma and orthopaedic surgery

The modular nature of the table provides a wide range of application for ALPHACLASSIC and BETACLASSIC. The 3-segment shoulder plate can easily be adapted and offers perfect access for the surgeon with side sections that can be removed.

Optimal patient positioning in a supine position. The optional longitudinal shift feature enables unobstructed imaging of vertebrae and improves access for the clinical team.



# TECHNICAL DATA

## Mobile OR table for universal surgery

### General features of the design:

- 1118.01: Pedal actuated hydraulic drive for the movement of height, tilting, and trendelenburg
- 1118.03: Electro hydraulically powered for movements of height, tilting, and trendelenburg  
Battery or mains supply (see electrical data)
- Stable construction of the base with large twin-disk-castors for easy travel and manoeuvring
- Base cover made of glass fibre reinforced plastic – resistant to cracks, breakage and disinfectants
- Entire table top frame and column cladding are made of stainless Cr-Ni steel

### Features and data on the table top:

- Divided into 5 parts, i.e. head plate (optional), back plate, seat plate, and leg plates (optional)
- SFC padding (Special Foam Core), thickness 80 mm
- Guide rails for X-ray cassettes inserted from the head end
- Reverse positioning of patients on a special shoulder plate (optional) that can be connected at the foot end of the table top

### Electrical data:

- Maintenance-free batteries providing capacity for approximately one week of operation
- Recharging of the batteries and supply of the OR table by means of a mains cord
- Classification as per appendix IX of the regulation 93/42/EWG, class I
- Nominal mains voltage (selectable) 100/110-115/127/200/220/230-240 V AC
- Mains frequency, 50/60 Hz

### Comfort and safety

1. Safe positioning as all joints and moving parts are covered
2. ALPHACLASSIC, the new operational concept
3. BETAClassic, ergonomically positioned control elements

### Required accessories

#### ALPHACLASSIC 1118.03:

- 1118.90A0 corded hand control

### Required accessories

#### (with PUR padding):

- 1130.64D0 head plate, inclinable, PUR padding
- 1118.50A0 pair of leg plates, can be folded down and spread – PUR padding

### Required accessories

#### (with SFC padding):

- 1130.64C0 head plate, inclinable, SFC padding
- 1118.50B0 pair of leg plates, can be folded down and spread – SFC padding

### Optional accessories

#### ALPHACLASSIC 1118.03:

- 1118.91A0 IR remote control
- 3110.26C9 Charging unit for the remote control
- 1009.81E1 Foot switch



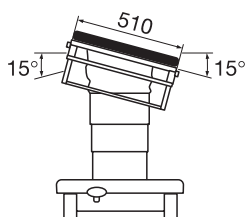
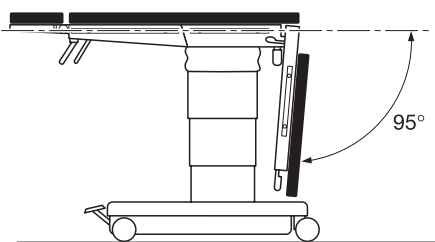
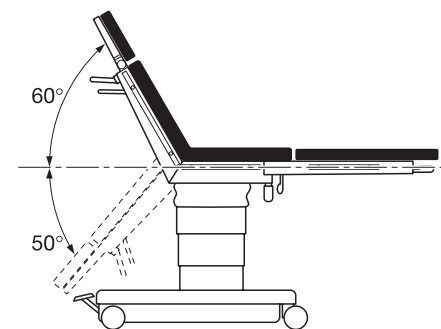
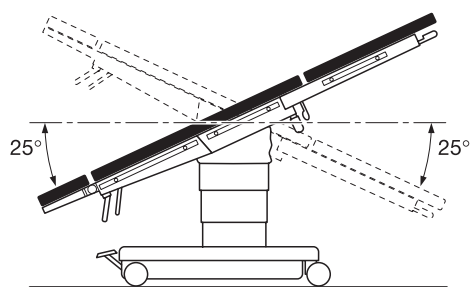
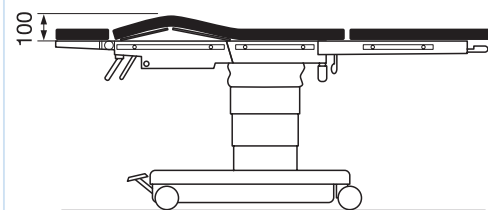
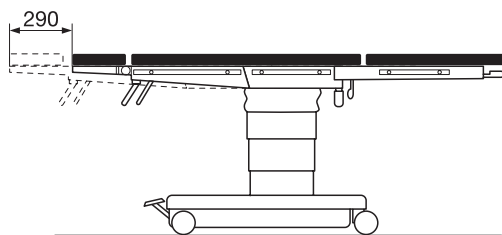
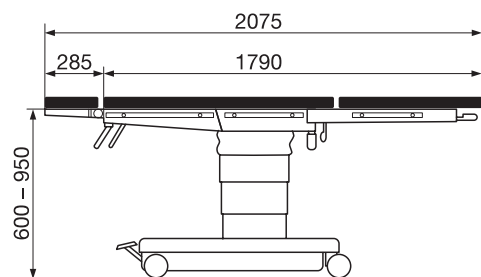

## Classic Models

BETACLASSIC			
Order numbers	Pads	Body elevator	Longitudinal shift
1118.01A0	PUR	-	-
1118.01B0	SFC	-	-
1118.01G0	SFC	■	-
1118.01J0	PUR	-	■
1118.01K0	SFC	-	■
ALPHACLASSIC			
1118.03A0	PUR	-	-
1118.03B0	SFC	-	-
1118.03G0	SFC	■	-
1118.03J0	PUR	-	■
1118.03K0	SFC	-	■

Dimensions	ALPHACLASSIC / BETACLASSIC
Length including head plate	2075 mm
Length without head plate	1790 mm
Width	510 mm
Height (without padding)	600 mm – 950 mm
Trendelenburg and lateral tilt	
Trendelenburg, head down	25°
Trendelenburg, feet down	25°
Lateral tilt, both directions	15°
Leg plate and back plate	
Back plate, up	60°
Back plate, down	50°
Leg plate, up	0°
Leg plate, down	95°
Longitudinal shift	
Longitudinal shift	290 mm
Body elevator	
Body elevator	100 mm
Weights	
Weight of the OR table (without head and leg plates)	ca. 165 kg
Maximum patient weight	135 kg
Maximum weight of accessories (in addition to patient)	20 kg



## Subsidiaries

### Australia:

MAQUET Australia Pty Ltd  
P.O. Box 50, Bulimba  
Queensland 4171, Australia  
Phone: +61 (0) 7 33 99 33 11

### China:

MAQUET (Shanghai) Medical Equipment Co., Ltd.  
1988-91 Tower B, City Centre of Shanghai,  
100 Zun Yi Road, Shanghai 200051, P.R. China  
Phone: +86 (0) 21 62371957

### Finland:

MAQUET Nordic Suomi  
Vattuniemenkatu 23  
00210 Helsinki, Finland  
Phone: +358 9 682 412 60

### Hong Kong:

MAQUET Hong Kong Limited  
1105-1107 Grand Century Place I  
193 Prince Edward Road West  
Mongkok, Kowloon, Hong Kong  
Phone: +852 2393 9 511

### India:

MAQUET Medical India Pvt. Ltd.  
102, Pressman House  
70A, Nehru Road  
Vile Parle (East)  
Mumbai 400 099, India  
Phone: +91 (0) 22 6675 5551-2-3

### Japan:

MAQUET Japan K.K.  
Seafort Square Building, 7th Floor  
2-3-12, Higashishinagawa, Shinagawa-ku  
Tokyo, 140-0002, Japan  
Phone: +81 (0) 3 5463-8310

### Latin America:

MAQUET do Brasil Ltda.  
Rua Said Aiach 161, Paraíso  
04003-20 São Paulo/SP, Brasil  
Phone: +55 (0) 11 2126 2500

### Netherlands:

MAQUET Netherlands B.V.  
Oscar Romerolaan 3  
1216 TJ Hilversum, Netherlands  
P.O. Box 388  
1200 AJ Hilversum, Netherlands  
Phone: +31 (0) 35 6255320

### Republic of Ireland:

MAQUET Ireland  
Unit B6  
Calmount Business Park  
Ballymount  
Dublin 12, Republic of Ireland  
Phone: +353 (0) 142 60032

### Russia:

MAQUET LLC  
Stanislavskogo 21, Bld. 7  
109004 Moscow, Russia  
Phone: +7 495 514 0055

### Singapore:

MAQUET South East Asia Pte Ltd.  
20 Bendemeer Road  
#06-01/02 Cyberhub Building  
Singapore 339914, Singapore  
Phone: +65 6 296 1992

### Slovakia:

MAQUET Medizintechnik  
Vertrieb und Service GmbH – o.z.  
Soltsovej 12  
811 08 Bratislava, Slovakia  
Phone: +421 2 50219 150

### United Kingdom:

MAQUET Ltd.  
14-15 Burford Way  
Baldon Business Park  
Sunderland  
Tyne & Wear, NE35 9PZ, United Kingdom  
Phone: +44 (0) 191 519 6200

### For local contact:

Please visit our Website  
[www.maquet.com](http://www.maquet.com)

# MAQUET

MAQUET GmbH & Co. KG  
Kehler Straße 31  
D-76437 Rastatt, Germany  
Phone: +49 (0) 7222 932-0  
Fax: +49 (0) 7222 932-571  
Service-Hotline: +49 (0) 7222 932-745  
[info.sales@maquet.de](mailto:info.sales@maquet.de)  
[www.maquet.com](http://www.maquet.com)

## GETINGE

GETINGE GROUP is a leading global provider of equipment and systems that contribute to quality enhancement and cost efficiency within healthcare and life sciences. Equipment, services and technologies are supplied under the brands ARJO for patient hygiene, patient handling and wound care, GETINGE for infection control and prevention within healthcare and life science and MAQUET for Surgical Workplaces, Cardiopulmonary and Critical Care.