



PROMOTAL®

# swifi®

CHAISE DE TRANSFERT  
*TRANSFER CHAIR*



Un concept unique pour accueillir dignement vos patients !  
*A unique concept for greater patient dignity!*

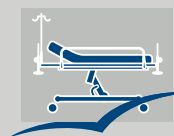



Appui bras relevables  
Adjustable arm rests



Freinage centralisé  
Centralised brakes



Repose pied escamotable  
par commande bilaterale  
Retractable footrest  
with bilateral control

## CARACTÉRISTIQUES STANDARD STANDARD FEATURES

**2 largeurs 47 ou 60 cm**  
**2 widths 47 or 60cm**

**Capacité de charge : 200 kg (testé en statique à 600 kg)**  
**Patient weight capacity: 200kg (tested at a static weight of 600kg)**

Structure en tôle d'acier électrozingué avec finition époxy gris nuage  
Electrogalvanized steel frame with light grey epoxy finish

Poignée de poussée finition époxy assortie à la sellerie  
Epoxy finished push bar matching upholstery color

Assise et dossier avec revêtement non feu M1, sans couture  
Backrest and seat in class M1 flame retardant seamless covering

Support dossier patient  
Patient file holder

Panier à vêtements  
Clothes basket

Appui bras relevables avec butée  
Adjustable arm rests with stopper

Repose pied escamotable par commande bilaterale  
Retractable footrest with bilateral control

Pare-chocs annulaires avant  
Front shock absorbers

Roues arrières ø 300 mm avec freinage centralisé.  
Rear castors ø 300mm with centralized brakes

Roues avant ø 100 mm – roulements à billes.  
Front castors ø 100mm – ball bearing

Hauteur d'assise de 58 cm  
58cm seat height

Capacité / Capacity  
**200 KG**

### Une conception innovante pour une fiabilité extrême A revolutionary concept for extreme reliability

PROMOTAL innove en créant Swifi®, la première chaise de transfert créée sur la base d'un châssis métallique monobloc. Swifi® est conçue exclusivement pour le milieu hospitalier : une grande rigidité et longévité, une manœuvrabilité facile ainsi qu'une gamme élargie d'accessoires dont Swing IV®, un système exclusif de tige porte sérum rotative.

PROMOTAL innovates in creating Swifi®, the first transfer chair created using a mono block metallic frame. Swifi® was designed exclusively for a hospital environment: greater rigidity and a longer life span, easy manoeuvrability and a large range of accessories including Swing IV®, an exclusive system of rotating IV pole.



**30130-02**



## Respect de la dignité du patient Respect of patient dignity

Swift® est une chaise de transfert à la ligne résolument moderne et accueillante qui contribue à diminuer l'anxiété du patient dès son arrivée à l'hôpital. L'intimité du patient est respectée lors de la manœuvre du repose-pied grâce à sa commande bilatérale.

Swift® is a transfer chair with an ultra modern and welcoming design that contributes to reducing patient anxiety on arrival at a hospital. The patient's intimacy is respected when manipulating the footrest due to its bilateral control.



30130-02L

## Le confort pour tous vos patients Comfort for all patients

La chaise de transfert Swift® facilite l'accueil de tous les patients, notamment les patients à mobilité réduite ou corpulents : sa capacité de charge de 200 kg, son assise ouverte sur les côtés, ses appui-bras relevables et son repose-pieds escamotable permettent indifféremment un accueil latéral ou frontal aisé.

The Swift® transfer chair allows easy access for all patients, notably reduced mobility or corpulent patients. A patient weight capacity of 200kg, an open-sided seat, swing-back armrests and a sliding footrest ensure both lateral and frontal access comfortably.

## ACCESSOIRES / ACCESSORIES

30143-01



Ceinture de maintien  
Safety belt

30148-20



Etou ø 16mm  
Clamp ø 16mm

30149-01L



Repose jambe avec ancrage  
pour 30130-01L  
Legrest with fitting  
for 30130-01L



30149-01

Repose jambe avec ancrage  
pour 30130-01  
Leg rest with fixings  
for 30130-01

30141-01



Appui-tête  
Head rest

30145-02

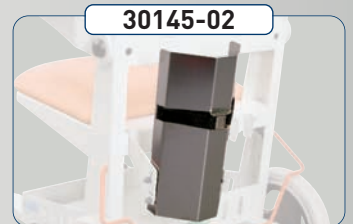

Support bouteille oxygène  
Oxygen bottle holder  
(ø maxi 160 x h 620)

30140-01



Support poche urine  
Urine bag support

30142-01 + 30148-20



Tablette support  
Support tray

30148-10

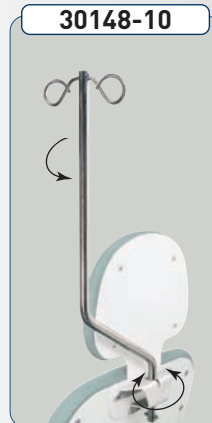

Swing IV®  
Tige porte sérum rotative  
Rotating IV pole

30148-01  
+ 30148-20

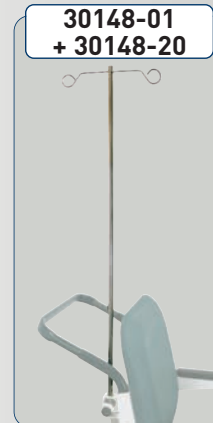

Tige porte sérum  
2 crochets  
2 hook IV pole

2985-01  
+ 30148-20 \*

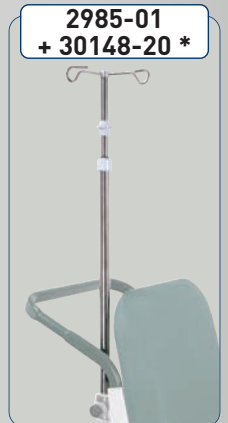

Tige porte sérum  
autobloquant 2 crochets  
2 hook auto-locking IV pole

30147-01



Consigneur  
avec fixation murale  
Coin holder  
with wall fixings

30147-10



Consigneur spécial  
avec 10 jetons avec fixation murale  
Special chair lock  
with 10 tokens with wall fixings

30147-20



Jeu de 10 jetons  
pour 30147-10  
Set of 10 tokens  
for 30147-10

\* Livré avec système antivol (entretroise nylon)  
\* Delivered with antitheft device

30130-02

**DIMENSIONS (mm)**

30130-02L

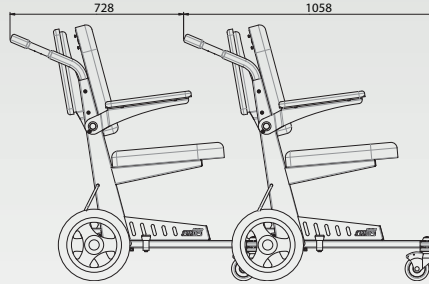
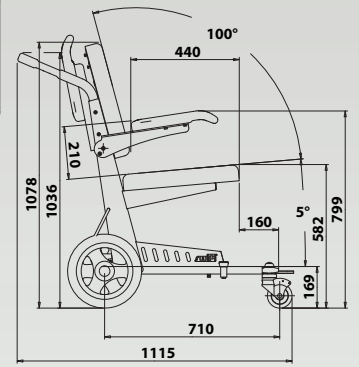
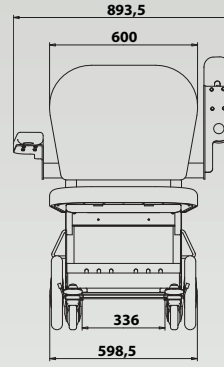
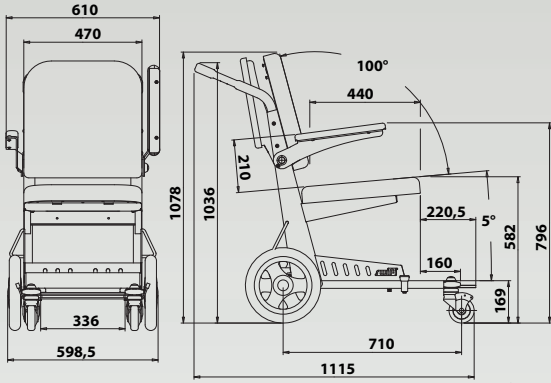

Poids net / Net weight ..... 37 kg  
 Poids brut / Gross weight ..... 42 kg  
 (+ palette/pallet = + 15 kg)  
 Volume ..... 0,9 m<sup>3</sup>  
 (+ palette/pallet = 1 m<sup>3</sup>)

Poids net / Net weight ..... 44 kg  
 Poids brut / Gross weight ..... 50 kg  
 (+ palette/pallet = + 15 kg)  
 Volume ..... 1,22 m<sup>3</sup>  
 (+ palette/pallet = 1,350 m<sup>3</sup>)

**CHOIX DES COULEURS DE SELLERIES - CHOICE OF UPHOLSTERY COLORS**

**REVÊTEMENT NON-FEU M1 / M1 UPHOLSTERY**

**Basic**



32 - BLEU / BLUE



33 - VERT / GREEN



34 - JAUNE / YELLOW



35 - ROUGE / RED



36 - ORANGE / ORANGE

**Trendy**

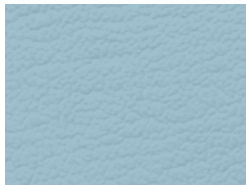

62 - AZUR / AZURE

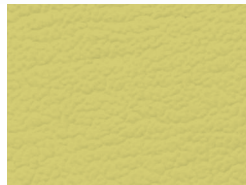

63 - CEDRAT / CEDRAT



64 - RAISIN / GRAPE

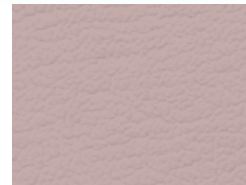

65 - LILAS / LILAC

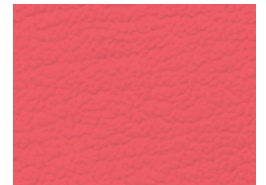

66 - BONBON / SWEET

**Classic**



92 - MARINE / MARINE



93 - COTTAGE / COTTAGE

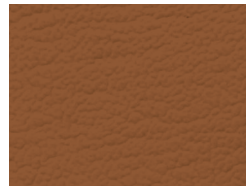

94 - MUSCADE / NUTMEG

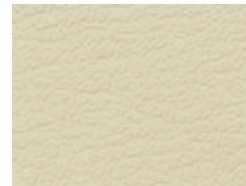

95 - NÉVÉ / FIRN

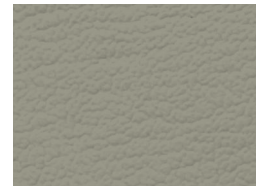

96 - ÉTAIN / TIN

**Noirs**

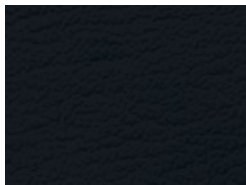

56 - OBSCURE / DARKNESS

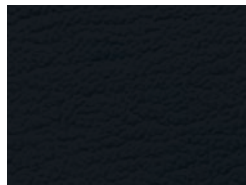

57 - ANTISTATIC\*/ANTISTATIC\*

\* Non classé M1  
 Not classified M1

**REVÊTEMENT RITTER\*\*  
 RITTER UPHOLSTERY\*\***



C1 - NAVY



C2 - DUSTY BLUE



C3 - MOSS

\*\* Uniquement pour certains produits de la gamme Promotal.  
 Only for some products from Promotal range.



G004/FE-04/11



PROMOTAL - FRANCE | [www.promotal.com](http://www.promotal.com)

