

BECKER



**CHROME NICKEL STEEL RACK
SYSTEMS AND PACKING TABLES**

INFORMATION

**704
E**

BECKER



Three different types of chrome nickel steel racks

- Rack system, **standard** with loading capacity up to 150 kg and 1000 mm width
- Rack system, **reinforced** with loading capacity up to 200 kg and 1000 mm width
- BECKER **SB** rack system with varying load capacity according to board type

All racks with 400, 500 or 600 mm depth measurements and many different widths

See page 7.1 to 7.6

BECKER wall rack system made of aluminum profiles

choose storage boards from wood, sheet steel, or chrome nickel steel

See page 7.7



BECKER SYSTEMS for:

**wards
out-patient departments
operating rooms
treatment rooms
sterilization**



Model P 10



Model P 20



Model PR 10



Model PR 20

**Packing tables
made of chrome nickel steel**

six models with standard variations in
depth and width
stationary, mobile and height adjustable
with or without lower storage board

See page 7.8 to 7.12



Model PH 10



Matching sterile goods packing rack

available in four different widths and
three designs:
wall mountable, or single sided and
double sided table top

See pages 7.13. to 7.16





Chrome nickel steel rack system - standard - consisting of base unit and extension units

BECKER shelving units are made of high-grade chrome nickel steel, alloy AISI 304 (1.4301), surface finished to grain 240/320.

The system assembles a base unit and extension units.

Base units consist of 2 side supports and 4 shelves with 40 mm fold-over on all sides. The top and bottom shelves are welded to the side supports and other shelves can be screwed to side supports at 100 mm intervals as required.

Extension units consist of one side support and 4 shelves with 40 mm fold-over on all sides to be screwed to side supports at 100 mm intervals as required.

| | | Depth: 400 mm | | |
|---|--|------------------------|---------------|--|
| | DESIGNATION | DIMENSIONS (W x D x H) | ORDER NO. | |
|  | Base unit standard with 4 shelves, not reinforced | 450 x 400 x 2000 mm | RG 2040 4 045 | |
| | | 500 x 400 x 2000 mm | RG 2040 4 050 | |
| | | 600 x 400 x 2000 mm | RG 2040 4 060 | |
| | | 700 x 400 x 2000 mm | RG 2040 4 070 | |
| | | 800 x 400 x 2000 mm | RG 2040 4 080 | |
| | | 900 x 400 x 2000 mm | RG 2040 4 090 | |
| | | 1000 x 400 x 2000 mm | RG 2040 4 100 | |
| | | 1100 x 400 x 2000 mm | RG 2040 4 110 | |
| | | 1200 x 400 x 2000 mm | RG 2040 4 120 | |
| | | 1300 x 400 x 2000 mm | RG 2040 4 130 | |
| | | 1400 x 400 x 2000 mm | RG 2040 4 140 | |
| | | 1500 x 400 x 2000 mm | RG 2040 4 150 | |
| | | 1600 x 400 x 2000 mm | RG 2040 4 160 | |
|  | Extension unit standard with 4 shelves, not reinforced | 425 x 400 x 2000 mm | RA 2040 4 045 | |
| | | 475 x 400 x 2000 mm | RA 2040 4 050 | |
| | | 575 x 400 x 2000 mm | RA 2040 4 060 | |
| | | 675 x 400 x 2000 mm | RA 2040 4 070 | |
| | | 775 x 400 x 2000 mm | RA 2040 4 080 | |
| | | 875 x 400 x 2000 mm | RA 2040 4 090 | |
| | | 975 x 400 x 2000 mm | RA 2040 4 100 | |
| | | 1075 x 400 x 2000 mm | RA 2040 4 110 | |
| | | 1175 x 400 x 2000 mm | RA 2040 4 120 | |
| | | 1275 x 400 x 2000 mm | RA 2040 4 130 | |
| | | 1375 x 400 x 2000 mm | RA 2040 4 140 | |
| | | 1475 x 400 x 2000 mm | RA 2040 4 150 | |
| | | 1575 x 400 x 2000 mm | RA 2040 4 160 | |
|  | Shelves optional, not reinforced (widths at par) | 450 x 400 x 40 mm | RB 40 045 | |
| | | 500 x 400 x 40 mm | RB 40 050 | |
| | | 600 x 400 x 40 mm | RB 40 060 | |
| | | 700 x 400 x 40 mm | RB 40 070 | |
| | | 800 x 400 x 40 mm | RB 40 080 | |
| | | 900 x 400 x 40 mm | RB 40 090 | |
| | | 1000 x 400 x 40 mm | RB 40 100 | |
| | | 1100 x 400 x 40 mm | RB 40 110 | |
| | | 1200 x 400 x 40 mm | RB 40 120 | |
| | | 1300 x 400 x 40 mm | RB 40 130 | |
| | | 1400 x 400 x 40 mm | RB 40 140 | |
| | | 1500 x 400 x 40 mm | RB 40 150 | |
| 1600 x 400 x 40 mm | RB 40 160 | | | |

Description

- High-grade chrome nickel steel, alloy AISI 304 (1.4301), surface finished to grain 240/320
- Side supports, square tube 25 x 25 x 1.5 mm
- Shelves 1.25 mm material thickness

Standard dimensions

Height: 2000 mm
 Width: 450 mm - 1600 mm
 Depth: 400, 500 and 600 mm

Surface load per shelf

Width: 450 - 1000 mm about 150 kg*
 Width: 1100 - 1300 mm about 120 kg*
 Width: 1400 - 1600 mm about 100 kg*
 (* evenly distributed)

Custom dimensions available upon request

Depth: 500 mm

| DIMENSIONS (W x D x H) | ORDER NO. |
|------------------------|---------------|
| 450 x 500 x 2000 mm | RG 2050 4 045 |
| 500 x 500 x 2000 mm | RG 2050 4 050 |
| 600 x 500 x 2000 mm | RG 2050 4 060 |
| 700 x 500 x 2000 mm | RG 2050 4 070 |
| 800 x 500 x 2000 mm | RG 2050 4 080 |
| 900 x 500 x 2000 mm | RG 2050 4 090 |
| 1000 x 500 x 2000 mm | RG 2050 4 100 |
| 1100 x 500 x 2000 mm | RG 2050 4 110 |
| 1200 x 500 x 2000 mm | RG 2050 4 120 |
| 1300 x 500 x 2000 mm | RG 2050 4 130 |
| 1400 x 500 x 2000 mm | RG 2050 4 140 |
| 1500 x 500 x 2000 mm | RG 2050 4 150 |
| 1600 x 500 x 2000 mm | RG 2050 4 160 |

Depth: 600 mm

| DIMENSIONS (W x D x H) | ORDER NO. |
|------------------------|---------------|
| 450 x 600 x 2000 mm | RG 2060 4 045 |
| 500 x 600 x 2000 mm | RG 2060 4 050 |
| 600 x 600 x 2000 mm | RG 2060 4 060 |
| 700 x 600 x 2000 mm | RG 2060 4 070 |
| 800 x 600 x 2000 mm | RG 2060 4 080 |
| 900 x 600 x 2000 mm | RG 2060 4 090 |
| 1000 x 600 x 2000 mm | RG 2060 4 100 |
| 1100 x 600 x 2000 mm | RG 2060 4 110 |
| 1200 x 600 x 2000 mm | RG 2060 4 120 |
| 1300 x 600 x 2000 mm | RG 2060 4 130 |
| 1400 x 600 x 2000 mm | RG 2060 4 140 |
| 1500 x 600 x 2000 mm | RG 2060 4 150 |
| 1600 x 600 x 2000 mm | RG 2060 4 160 |

| | |
|----------------------|---------------|
| 425 x 500 x 2000 mm | RA 2050 4 045 |
| 475 x 500 x 2000 mm | RA 2050 4 050 |
| 575 x 500 x 2000 mm | RA 2050 4 060 |
| 675 x 500 x 2000 mm | RA 2050 4 070 |
| 775 x 500 x 2000 mm | RA 2050 4 080 |
| 875 x 500 x 2000 mm | RA 2050 4 090 |
| 975 x 500 x 2000 mm | RA 2050 4 100 |
| 1075 x 500 x 2000 mm | RA 2050 4 110 |
| 1175 x 500 x 2000 mm | RA 2050 4 120 |
| 1275 x 500 x 2000 mm | RA 2050 4 130 |
| 1375 x 500 x 2000 mm | RA 2050 4 140 |
| 1475 x 500 x 2000 mm | RA 2050 4 150 |
| 1575 x 500 x 2000 mm | RA 2050 4 160 |

| | |
|----------------------|---------------|
| 425 x 600 x 2000 mm | RA 2060 4 045 |
| 475 x 600 x 2000 mm | RA 2060 4 050 |
| 575 x 600 x 2000 mm | RA 2060 4 060 |
| 675 x 600 x 2000 mm | RA 2060 4 070 |
| 775 x 600 x 2000 mm | RA 2060 4 080 |
| 875 x 600 x 2000 mm | RA 2060 4 090 |
| 975 x 600 x 2000 mm | RA 2060 4 100 |
| 1075 x 600 x 2000 mm | RA 2060 4 110 |
| 1175 x 600 x 2000 mm | RA 2060 4 120 |
| 1275 x 600 x 2000 mm | RA 2060 4 130 |
| 1375 x 600 x 2000 mm | RA 2060 4 140 |
| 1475 x 600 x 2000 mm | RA 2060 4 150 |
| 1575 x 600 x 2000 mm | RA 2060 4 160 |

| | |
|--------------------|-----------|
| 450 x 500 x 40 mm | RB 50 045 |
| 500 x 500 x 40 mm | RB 50 050 |
| 600 x 500 x 40 mm | RB 50 060 |
| 700 x 500 x 40 mm | RB 50 070 |
| 800 x 500 x 40 mm | RB 50 080 |
| 900 x 500 x 40 mm | RB 50 090 |
| 1000 x 500 x 40 mm | RB 50 100 |
| 1100 x 500 x 40 mm | RB 50 110 |
| 1200 x 500 x 40 mm | RB 50 120 |
| 1300 x 500 x 40 mm | RB 50 130 |
| 1400 x 500 x 40 mm | RB 50 140 |
| 1500 x 500 x 40 mm | RB 50 150 |
| 1600 x 500 x 40 mm | RB 50 160 |

| | |
|--------------------|-----------|
| 450 x 600 x 40 mm | RB 60 045 |
| 500 x 600 x 40 mm | RB 60 050 |
| 600 x 600 x 40 mm | RB 60 060 |
| 700 x 600 x 40 mm | RB 60 070 |
| 800 x 600 x 40 mm | RB 60 080 |
| 900 x 600 x 40 mm | RB 60 090 |
| 1000 x 600 x 40 mm | RB 60 100 |
| 1100 x 600 x 40 mm | RB 60 110 |
| 1200 x 600 x 40 mm | RB 60 120 |
| 1300 x 600 x 40 mm | RB 60 130 |
| 1400 x 600 x 40 mm | RB 60 140 |
| 1500 x 600 x 40 mm | RB 60 150 |
| 1600 x 600 x 40 mm | RB 60 160 |



Chrome nickel steel rack system - reinforced - consisting of base unit and extension units

BECKER shelving units are made of high-grade chrome nickel steel, alloy AISI 304 (1.4301), surface finished to grain 240/320.

The system assembles a base unit and extension units.

Base units consist of 2 side supports and 4 **reinforced** shelves with 40 mm fold-over on all sides. The top and bottom shelves are welded to the side supports and other shelves can be screwed to side supports at 100 mm intervals as required.

Extension units consist of one side support and 4 **reinforced** shelves with 40 mm fold-over on all sides to be screwed to side supports at 100 mm intervals as required.

| | | Depth: 400 mm | | |
|---|--|------------------------|----------------|--|
| | DESIGNATION | DIMENSIONS (W x D x H) | ORDER NO. | |
|  | Base unit with 4 shelves, reinforced | 450 x 400 x 2000 mm | RGV 2040 4 045 | |
| | | 500 x 400 x 2000 mm | RGV 2040 4 050 | |
| | | 600 x 400 x 2000 mm | RGV 2040 4 060 | |
| | | 700 x 400 x 2000 mm | RGV 2040 4 070 | |
| | | 800 x 400 x 2000 mm | RGV 2040 4 080 | |
| | | 900 x 400 x 2000 mm | RGV 2040 4 090 | |
| | | 1000 x 400 x 2000 mm | RGV 2040 4 100 | |
| | | 1100 x 400 x 2000 mm | RGV 2040 4 110 | |
| | | 1200 x 400 x 2000 mm | RGV 2040 4 120 | |
| | | 1300 x 400 x 2000 mm | RGV 2040 4 130 | |
| | | 1400 x 400 x 2000 mm | RGV 2040 4 140 | |
| | | 1500 x 400 x 2000 mm | RGV 2040 4 150 | |
| | | 1600 x 400 x 2000 mm | RGV 2040 4 160 | |
|  | Extension unit with 4 shelves, reinforced | 425 x 400 x 2000 mm | RAV 2040 4 045 | |
| | | 475 x 400 x 2000 mm | RAV 2040 4 050 | |
| | | 575 x 400 x 2000 mm | RAV 2040 4 060 | |
| | | 675 x 400 x 2000 mm | RAV 2040 4 070 | |
| | | 775 x 400 x 2000 mm | RAV 2040 4 080 | |
| | | 875 x 400 x 2000 mm | RAV 2040 4 090 | |
| | | 975 x 400 x 2000 mm | RAV 2040 4 100 | |
| | | 1075 x 400 x 2000 mm | RAV 2040 4 110 | |
| | | 1175 x 400 x 2000 mm | RAV 2040 4 120 | |
| | | 1275 x 400 x 2000 mm | RAV 2040 4 130 | |
| | | 1375 x 400 x 2000 mm | RAV 2040 4 140 | |
| | | 1475 x 400 x 2000 mm | RAV 2040 4 150 | |
| | | 1575 x 400 x 2000 mm | RAV 2040 4 160 | |
|  | Shelves optional, reinforced (widths at par) | 450 x 400 x 40 mm | RBV 40 045 | |
| | | 500 x 400 x 40 mm | RBV 40 050 | |
| | | 600 x 400 x 40 mm | RBV 40 060 | |
| | | 700 x 400 x 40 mm | RBV 40 070 | |
| | | 800 x 400 x 40 mm | RBV 40 080 | |
| | | 900 x 400 x 40 mm | RBV 40 090 | |
| | | 1000 x 400 x 40 mm | RBV 40 100 | |
| | | 1100 x 400 x 40 mm | RBV 40 110 | |
| | | 1200 x 400 x 40 mm | RBV 40 120 | |
| | | 1300 x 400 x 40 mm | RBV 40 130 | |
| | | 1400 x 400 x 40 mm | RBV 40 140 | |
| | | 1500 x 400 x 40 mm | RBV 40 150 | |
| | | 1600 x 400 x 40 mm | RBV 40 160 | |

Description

- High-grade chrome nickel steel, alloy AISI 304 (1.4301), surface finished to grain 240/320
- Side supports, square tube 25 x 25 x 1.5 mm
- Shelves 1.25 mm material thickness

reinforced by treads
Standard dimensions

Height: 2000 mm
 Width: 450 mm - 1600 mm
 Depth: 400, 500 and 600 mm

Custom dimensions available upon request
Surface load per shelf

Width: 450 - 1000 mm about 200 kg*
 Width: 1100 - 1300 mm about 150 kg*
 Width: 1400 - 1600 mm about 130 kg*
 (* evenly distributed)

Depth: 500 mm

| DIMENSIONS (W x D x H) | ORDER NO. |
|------------------------|----------------|
| 450 x 500 x 2000 mm | RGV 2050 4 045 |
| 500 x 500 x 2000 mm | RGV 2050 4 050 |
| 600 x 500 x 2000 mm | RGV 2050 4 060 |
| 700 x 500 x 2000 mm | RGV 2050 4 070 |
| 800 x 500 x 2000 mm | RGV 2050 4 080 |
| 900 x 500 x 2000 mm | RGV 2050 4 090 |
| 1000 x 500 x 2000 mm | RGV 2050 4 100 |
| 1100 x 500 x 2000 mm | RGV 2050 4 110 |
| 1200 x 500 x 2000 mm | RGV 2050 4 120 |
| 1300 x 500 x 2000 mm | RGV 2050 4 130 |
| 1400 x 500 x 2000 mm | RGV 2050 4 140 |
| 1500 x 500 x 2000 mm | RGV 2050 4 150 |
| 1600 x 500 x 2000 mm | RGV 2050 4 160 |

Depth: 600 mm

| DIMENSIONS (W x D x H) | ORDER NO. |
|------------------------|----------------|
| 450 x 600 x 2000 mm | RGV 2060 4 045 |
| 500 x 600 x 2000 mm | RGV 2060 4 050 |
| 600 x 600 x 2000 mm | RGV 2060 4 060 |
| 700 x 600 x 2000 mm | RGV 2060 4 070 |
| 800 x 600 x 2000 mm | RGV 2060 4 080 |
| 900 x 600 x 2000 mm | RGV 2060 4 090 |
| 1000 x 600 x 2000 mm | RGV 2060 4 100 |
| 1100 x 600 x 2000 mm | RGV 2060 4 110 |
| 1200 x 600 x 2000 mm | RGV 2060 4 120 |
| 1300 x 600 x 2000 mm | RGV 2060 4 130 |
| 1400 x 600 x 2000 mm | RGV 2060 4 140 |
| 1500 x 600 x 2000 mm | RGV 2060 4 150 |
| 1600 x 600 x 2000 mm | RGV 2060 4 160 |

| | |
|----------------------|----------------|
| 425 x 500 x 2000 mm | RAV 2050 4 045 |
| 475 x 500 x 2000 mm | RAV 2050 4 050 |
| 575 x 500 x 2000 mm | RAV 2050 4 060 |
| 675 x 500 x 2000 mm | RAV 2050 4 070 |
| 775 x 500 x 2000 mm | RAV 2050 4 080 |
| 875 x 500 x 2000 mm | RAV 2050 4 090 |
| 975 x 500 x 2000 mm | RAV 2050 4 100 |
| 1075 x 500 x 2000 mm | RAV 2050 4 110 |
| 1175 x 500 x 2000 mm | RAV 2050 4 120 |
| 1275 x 500 x 2000 mm | RAV 2050 4 130 |
| 1375 x 500 x 2000 mm | RAV 2050 4 140 |
| 1475 x 500 x 2000 mm | RAV 2050 4 150 |
| 1575 x 500 x 2000 mm | RAV 2050 4 160 |

| | |
|----------------------|----------------|
| 425 x 600 x 2000 mm | RAV 2060 4 045 |
| 475 x 600 x 2000 mm | RAV 2060 4 050 |
| 575 x 600 x 2000 mm | RAV 2060 4 060 |
| 675 x 600 x 2000 mm | RAV 2060 4 070 |
| 775 x 600 x 2000 mm | RAV 2060 4 080 |
| 875 x 600 x 2000 mm | RAV 2060 4 090 |
| 975 x 600 x 2000 mm | RAV 2060 4 100 |
| 1075 x 600 x 2000 mm | RAV 2060 4 110 |
| 1175 x 600 x 2000 mm | RAV 2060 4 120 |
| 1275 x 600 x 2000 mm | RAV 2060 4 130 |
| 1375 x 600 x 2000 mm | RAV 2060 4 140 |
| 1475 x 600 x 2000 mm | RAV 2060 4 150 |
| 1575 x 600 x 2000 mm | RAV 2060 4 160 |

| | |
|--------------------|------------|
| 450 x 500 x 40 mm | RBV 50 045 |
| 500 x 500 x 40 mm | RBV 50 050 |
| 600 x 500 x 40 mm | RBV 50 060 |
| 700 x 500 x 40 mm | RBV 50 070 |
| 800 x 500 x 40 mm | RBV 50 080 |
| 900 x 500 x 40 mm | RBV 50 090 |
| 1000 x 500 x 40 mm | RBV 50 100 |
| 1100 x 500 x 40 mm | RBV 50 110 |
| 1200 x 500 x 40 mm | RBV 50 120 |
| 1300 x 500 x 40 mm | RBV 50 130 |
| 1400 x 500 x 40 mm | RBV 50 140 |
| 1500 x 500 x 40 mm | RBV 50 150 |
| 1600 x 500 x 40 mm | RBV 50 160 |

| | |
|--------------------|------------|
| 450 x 600 x 40 mm | RBV 60 045 |
| 500 x 600 x 40 mm | RBV 60 050 |
| 600 x 600 x 40 mm | RBV 60 060 |
| 700 x 600 x 40 mm | RBV 60 070 |
| 800 x 600 x 40 mm | RBV 60 080 |
| 900 x 600 x 40 mm | RBV 60 090 |
| 1000 x 600 x 40 mm | RBV 60 100 |
| 1100 x 600 x 40 mm | RBV 60 110 |
| 1200 x 600 x 40 mm | RBV 60 120 |
| 1300 x 600 x 40 mm | RBV 60 130 |
| 1400 x 600 x 40 mm | RBV 60 140 |
| 1500 x 600 x 40 mm | RBV 60 150 |
| 1600 x 600 x 40 mm | RBV 60 160 |





SB rack system with chrome nickel steel elements

made of high-grade chrome nickel steel, alloy AISI 304 (1.4301), surfaced finished to grain 240/320 for on-site assembly.

Shelf systems constructed of standard elements in fixed widths.
Every second shelf unit is to be reinforced with appropriate bracing.

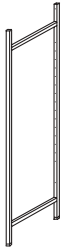
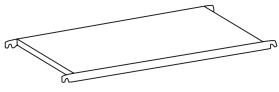
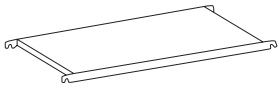
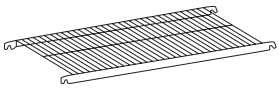
Depth: 400 mm

| | DESIGNATION | DIMENSIONS (W x D x H) | ORDER NO. |
|---|--|------------------------|------------|
|  | Side support made of CNS square tubing 25 x 25 x 1.5 mm with 2 adjustable feet and every 100 mm fastening points for shelves, for use right and left. | 400 x 1800 mm | RS 1840 |
| | | 400 x 2000 mm | RS 2040 |
| | | 400 x 2100 mm | RS 2140 |
|  | Shelf made of chrome nickel steel, not reinforced (widths at par) | 600 x 400 x 40 mm | RS 40 060 |
| | | 800 x 400 x 40 mm | RS 40 080 |
| | | 900 x 400 x 40 mm | RS 40 090 |
| | | 1000 x 400 x 40 mm | RS 40 100 |
| | | 1200 x 400 x 40 mm | RS 40 120 |
| | | 1400 x 400 x 40 mm | RS 40 140 |
|  | Shelf, reinforced made of chrome nickel steel (widths at par) | 600 x 400 x 40 mm | RSV 40 060 |
| | | 800 x 400 x 40 mm | RSV 40 080 |
| | | 900 x 400 x 40 mm | RSV 40 090 |
| | | 1000 x 400 x 40 mm | RSV 40 100 |
| | | 1200 x 400 x 40 mm | RSV 40 120 |
| | | 1400 x 400 x 40 mm | RSV 40 140 |
|  | Grid shelf made of chrome nickel steel (widths at par) | 600 x 400 x 43 mm | RSG 40 060 |
| | | 800 x 400 x 43 mm | RSG 40 080 |
| | | 900 x 400 x 43 mm | RSG 40 090 |
| | | 1000 x 400 x 43 mm | RSG 40 100 |
| | | 1200 x 400 x 43 mm | RSG 40 120 |
| | | 1400 x 400 x 43 mm | RSG 40 140 |
|  | Bracing for shelf unit width Note: every second shelf unit is to be braced. | 600 mm | RSP 060 |
| | | 800 mm | RSP 080 |
| | | 900 mm | RSP 090 |
| | | 1000 mm | RSP 100 |
| | | 1200 mm | RSP 120 |
| | | 1400 mm | RSP 140 |

Description

- High-grade chrome nickel steel, alloy AISI 304 (1.4301), surface finished to grain 240/320
- Side supports, square tube 25 x 25 x 1.5 mm
- Shelves in three versions: standard, reinforced or grid shelf

Standard dimensions

Height: 1800, 2000 and 2100 mm
 Width: 600, 800, 900, 1000, 1200 and 1400 mm
 Depth: 400, 500 and 600 mm

Surface load per shelf: up to 1200 mm width | 1400 mm width

| | | |
|-------------------|---------------|---------------|
| Shelf | about 120 kg* | about 90 kg* |
| Shelf, reinforced | about 150 kg* | about 120 kg* |
| Grid shelf | about 150 kg* | about 100 kg* |

(* evenly distributed)

Depth: 500 mm
Depth: 600 mm

| Depth: 500 mm | | | Depth: 600 mm | | |
|------------------------|------------|--|------------------------|------------|--|
| DIMENSIONS (W x D x H) | ORDER NO. | | DIMENSIONS (W x D x H) | ORDER NO. | |
| 500 x 1800 mm | RS 1850 | | 600 x 1800 mm | RS 1860 | |
| 500 x 2000 mm | RS 2050 | | 600 x 2000 mm | RS 2060 | |
| 500 x 2100 mm | RS 2150 | | 600 x 2100 mm | RS 2160 | |
| 600 x 500 x 40 mm | RS 50 060 | | 600 x 600 x 40 mm | RS 60 060 | |
| 800 x 500 x 40 mm | RS 50 080 | | 800 x 600 x 40 mm | RS 60 080 | |
| 900 x 500 x 40 mm | RS 50 090 | | 900 x 600 x 40 mm | RS 60 090 | |
| 1000 x 500 x 40 mm | RS 50 100 | | 1000 x 600 x 40 mm | RS 60 100 | |
| 1200 x 500 x 40 mm | RS 50 120 | | 1200 x 600 x 40 mm | RS 60 120 | |
| 1400 x 500 x 40 mm | RS 50 140 | | 1400 x 600 x 40 mm | RS 60 140 | |
| 600 x 500 x 40 mm | RSV 50 060 | | 600 x 600 x 40 mm | RSV 60 060 | |
| 800 x 500 x 40 mm | RSV 50 080 | | 800 x 600 x 40 mm | RSV 60 080 | |
| 900 x 500 x 40 mm | RSV 50 090 | | 900 x 600 x 40 mm | RSV 60 090 | |
| 1000 x 500 x 40 mm | RSV 50 100 | | 1000 x 600 x 40 mm | RSV 60 100 | |
| 1200 x 500 x 40 mm | RSV 50 120 | | 1200 x 600 x 40 mm | RSV 60 120 | |
| 1400 x 500 x 40 mm | RSV 50 140 | | 1400 x 600 x 40 mm | RSV 60 140 | |
| 600 x 500 x 43 mm | RSG 50 060 | | 600 x 600 x 43 mm | RSG 60 060 | |
| 800 x 500 x 43 mm | RSG 50 080 | | 800 x 600 x 43 mm | RSG 60 080 | |
| 900 x 500 x 43 mm | RSG 50 090 | | 900 x 600 x 43 mm | RSG 60 090 | |
| 1000 x 500 x 43 mm | RSG 50 100 | | 1000 x 600 x 43 mm | RSG 60 100 | |
| 1200 x 500 x 43 mm | RSG 50 120 | | 1200 x 600 x 43 mm | RSG 60 120 | |
| 1400 x 500 x 43 mm | RSG 50 140 | | 1400 x 600 x 43 mm | RSG 60 140 | |
| 600 mm | RSP 060 | | 600 mm | RSP 060 | |
| 800 mm | RSP 080 | | 800 mm | RSP 080 | |
| 900 mm | RSP 090 | | 900 mm | RSP 090 | |
| 1000 mm | RSP 100 | | 1000 mm | RSP 100 | |
| 1200 mm | RSP 120 | | 1200 mm | RSP 120 | |
| 1400 mm | RSP 140 | | 1400 mm | RSP 140 | |



Wall rack system

BECKER wall-mounted rack system includes 45 x 19 mm rails and supports (heavy-duty versions with depths of up to 600 mm) and shelves (different designs available). The maximum permissible distance between two rails is 800 mm.

Standard dimensions

Width: maximum single shelf width: 2400 mm

Depth: 300, 400, 500 and 600 mm

Height: max. 2500 mm

Rails and supports

- made of robust 45 x 19 mm or 45 x 32 mm aluminium sections, neutrally anodized
- supports, continuously adjustable in height
- groove-and-key locking system

Shelves in five variations

sheet steel, powder coated, colors check BECKER color card, material thickness 1.0 mm

RW **1** — single wall, folding of all sides, about 20 mm thick

RW **2** — double walled and cushioned, folding of all sides, about 20 mm thick

Chrome nickel steel alloy AISI 304 (1.4301), surface polished grain 320, material thickness 1.0 mm

RW **3** — single wall, folding of all sides, about 20 mm thick

RW **4** — double walled and cushioned, folding of all sides, about 20 mm thick

RW **7** — **wood**, upper and lower side with white laminated plastic, four sides ABS edge veneer, total thickness about 19 mm

| DESIGNATION | DIMENSIONS | ORDER NO. | |
|---|-----------------------------|-----------|--|
| Rail 45 x 19 mm | up to 1000 mm long | RWS 100 | |
| | up to 1500 mm long | RWS 150 | |
| | up to 2000 mm long | RWS 200 | |
| | up to 2500 mm long | RWS 250 | |
| Support incl. locking mechanism | up to 300 mm long (45 x 19) | RWK 30 | |
| | up to 400 mm long (45 x 19) | RWK 40 | |
| | up to 500 mm long (45 x 32) | RWK 50 | |
| | up to 600 mm long (45 x 32) | RWK 60 | |

| DESIGNATION | Depth: 300 mm | | | Depth: 400 mm | | |
|--|--------------------|------------|--|--------------------|------------|--|
| | DIMENSIONS (W x D) | ORDER NO. | | DIMENSIONS (W x D) | ORDER NO. | |
| Shelves Please replace „x“ with appropriate design number of board | 900 x 300 mm | RWx 30 090 | | 900 x 400 mm | RWx 40 090 | |
| | 1200 x 300 mm | RWx 30 120 | | 1200 x 400 mm | RWx 40 120 | |
| | 1500 x 300 mm | RWx 30 150 | | 1500 x 400 mm | RWx 40 150 | |
| | 1800 x 300 mm | RWx 30 180 | | 1800 x 400 mm | RWx 40 180 | |
| | 2000 x 300 mm | RWx 30 200 | | 2000 x 400 mm | RWx 40 200 | |
| | 2400 x 300 mm | RWx 30 240 | | 2400 x 400 mm | RWx 40 240 | |
| | | | | | | |
| | Depth: 500 mm | | | Depth: 600 mm | | |
| | 900 x 500 mm | RWx 50 090 | | 900 x 600 mm | RWx 60 090 | |
| | 1200 x 500 mm | RWx 50 120 | | 1200 x 600 mm | RWx 60 120 | |
| | 1500 x 500 mm | RWx 50 150 | | 1500 x 600 mm | RWx 60 150 | |
| | 1800 x 500 mm | RWx 50 180 | | 1800 x 600 mm | RWx 60 180 | |
| | 2000 x 500 mm | RWx 50 200 | | 2000 x 600 mm | RWx 60 200 | |
| | 2400 x 500 mm | RWx 50 240 | | 2400 x 600 mm | RWx 60 240 | |

PACKING TABLE HEIGHT ADJUSTABLE MODELS PH 10 AND PH 20



Packing table height adjustable

Made of high quality chrome nickel steel AISI 304 (1.4301) surface polished grain 240/320.

Lower frame made of square pipe 40 x 40 x 1.5 mm with stabilizing frame and reinforcing strut, as well as leveling legs. Four legs are combined with 2100 mm length and 6 legs are combined with maximum length of 2800 mm.

Smooth table surface, material thickness 1.0 mm, folding of all sides including filling material and sound proofing, lower side sealed with chrome nickel steel (CNS) sheet.

Height adjustment 720 mm to 1080 mm is done via an electric hydraulic maintenance free pumping system with remote control.

Electrical socket 230 V. Secondary voltage: 24 - 29 V / 13 A.

Maximum permitted load is 350 kg (including dead weight) which results in maximum loading weight of about 200 kg.

Model PH 10: as shown below with reinforcing strut

Model PH 20: Equipped with additional storage board inserted below - shortened about 1/3. Please note that here maximum load amounts to 180 kg.

| DESIGNATION | DIMENSIONS (W x D x H) | Model PH 10 | | Model PH 20 | |
|--|---|------------------------------|----------------|---|----------------|
| | | below with reinforcing strut | | with additional storage board inserted below, shortened about 1/3 | |
| | | ORDER NO. | | ORDER NO. | |
| Packing table height adjustable stationary ** with 6 legs Depth: 700 mm | 1200 x 700 x 720-1080 mm/h | PH 10 12 77 00 | | PH 20 12 77 00 | |
| | 1500 x 700 x 720-1080 mm/h | PH 10 15 77 00 | | PH 20 15 77 00 | |
| | 1800 x 700 x 720-1080 mm/h | PH 10 18 77 00 | | PH 20 18 77 00 | |
| | 2000 x 700 x 720-1080 mm/h | PH 10 20 77 00 | | PH 20 20 77 00 | |
| | 2100 x 700 x 720-1080 mm/h | PH 10 21 77 00 | | PH 20 21 77 00 | |
| | 2500 x 700 x 720-1080 mm/h ** | PH 10 25 77 00 | | PH 20 25 77 00 | |
| | 2800 x 700 x 720-1080 mm/h ** | PH 10 28 77 00 | | PH 20 28 77 00 | |
| | Depth: 800 mm | 1200 x 800 x 720-1080 mm/h | PH 10 12 87 00 | | PH 20 12 87 00 |
| 1500 x 800 x 720-1080 mm/h | | PH 10 15 87 00 | | PH 20 15 87 00 | |
| 1800 x 800 x 720-1080 mm/h | | PH 10 18 87 00 | | PH 20 18 87 00 | |
| 2000 x 800 x 720-1080 mm/h | | PH 10 20 87 00 | | PH 20 20 87 00 | |
| 2100 x 800 x 720-1080 mm/h | | PH 10 21 87 00 | | PH 20 21 87 00 | |
| 2500 x 800 x 720-1080 mm/h ** | | PH 10 25 87 00 | | PH 20 25 87 00 | |
| 2800 x 800 x 720-1080 mm/h ** | | PH 10 28 87 00 | | PH 20 28 87 00 | |
| Depth: 900 mm | | 1200 x 900 x 720-1080 mm/h | PH 10 12 97 00 | | PH 20 12 97 00 |
| | 1500 x 900 x 720-1080 mm/h | PH 10 15 97 00 | | PH 20 15 97 00 | |
| | 1800 x 900 x 720-1080 mm/h | PH 10 18 97 00 | | PH 20 18 97 00 | |
| | 2000 x 900 x 720-1080 mm/h | PH 10 20 97 00 | | PH 20 20 97 00 | |
| | 2100 x 900 x 720-1080 mm/h | PH 10 21 97 00 | | PH 20 21 97 00 | |
| | 2500 x 900 x 720-1080 mm/h ** | PH 10 25 97 00 | | PH 20 25 97 00 | |
| | 2800 x 900 x 720-1080 mm/h ** | PH 10 28 97 00 | | PH 20 28 97 00 | |
| | All measurements are standard measurements – please inquire about individual special requests. | | | | |



PACKING TABLE MODELS P 10 AND P 20

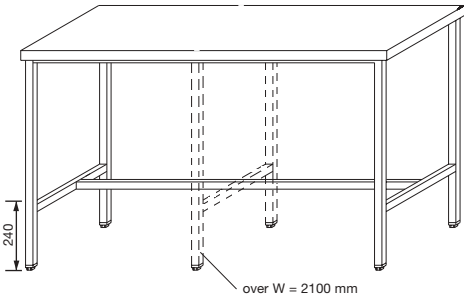

Packing table model P 10

made of high-grade chrome nickel steel, alloy AISI 304 (1.4301), surface finished, to grain 240/320.

Smooth table top, material thickness 1.0 mm, 40 mm fold-over on all sides, underside finished in chrome nickel steel plating.

Open frame of 30 x 30 mm square tubing, with side stabilizers and central reinforcing strut, feet adjustable in height. Total height approx. 900 mm.

Available depths: 600, 700, 800 and 900 mm.

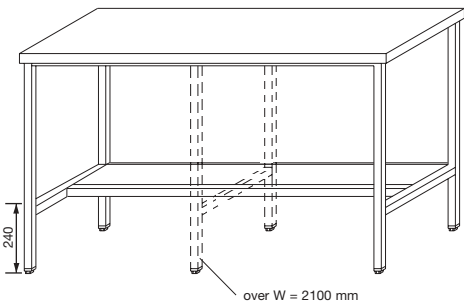

Packing table model P 20

made of high-grade chrome nickel steel, alloy AISI 304 (1.4301), surface finished, to grain 240/320.

Smooth table top, material thickness 1.0 mm, 40 mm fold-over on all sides, underside finished in chrome nickel steel plating.

Open frame of 30 x 30 mm square tubing, with side stabilizers and single-layer shelf, insert (shortened about 1/3). Feet adjustable in height. Total height approx. 900 mm.

Available depths: 600, 700, 800 and 900 mm.

| | Depth: 600 mm | | Depth: 700 mm | |
|--|------------------------|---------------|------------------------|---------------|
| | DIMENSIONS (W x D x H) | ORDER NO. | DIMENSIONS (W x D x H) | ORDER NO. |
| | 500 x 600 x 900 mm | P 10 05 69 00 | 500 x 700 x 900 mm | P 10 05 79 00 |
| | 600 x 600 x 900 mm | P 10 06 69 00 | 600 x 700 x 900 mm | P 10 06 79 00 |
| | 700 x 600 x 900 mm | P 10 07 69 00 | 700 x 700 x 900 mm | P 10 07 79 00 |
| | 800 x 600 x 900 mm | P 10 08 69 00 | 800 x 700 x 900 mm | P 10 08 79 00 |
| | 900 x 600 x 900 mm | P 10 09 69 00 | 900 x 700 x 900 mm | P 10 09 79 00 |
| | 1000 x 600 x 900 mm | P 10 10 69 00 | 1000 x 700 x 900 mm | P 10 10 79 00 |
| | 1100 x 600 x 900 mm | P 10 11 69 00 | 1100 x 700 x 900 mm | P 10 11 79 00 |
| | 1200 x 600 x 900 mm | P 10 12 69 00 | 1200 x 700 x 900 mm | P 10 12 79 00 |
| | 1300 x 600 x 900 mm | P 10 13 69 00 | 1300 x 700 x 900 mm | P 10 13 79 00 |
| | 1400 x 600 x 900 mm | P 10 14 69 00 | 1400 x 700 x 900 mm | P 10 14 79 00 |
| | 1500 x 600 x 900 mm | P 10 15 69 00 | 1500 x 700 x 900 mm | P 10 15 79 00 |
| | 1600 x 600 x 900 mm | P 10 16 69 00 | 1600 x 700 x 900 mm | P 10 16 79 00 |
| | 1700 x 600 x 900 mm | P 10 17 69 00 | 1700 x 700 x 900 mm | P 10 17 79 00 |
| | 1800 x 600 x 900 mm | P 10 18 69 00 | 1800 x 700 x 900 mm | P 10 18 79 00 |
| | 1900 x 600 x 900 mm | P 10 19 69 00 | 1900 x 700 x 900 mm | P 10 19 79 00 |
| | 2000 x 600 x 900 mm | P 10 20 69 00 | 2000 x 700 x 900 mm | P 10 20 79 00 |
| | 2100 x 600 x 900 mm | P 10 21 69 00 | 2100 x 700 x 900 mm | P 10 21 79 00 |
| | 2200 x 600 x 900 mm | P 10 22 69 00 | 2200 x 700 x 900 mm | P 10 22 79 00 |
| | 2300 x 600 x 900 mm | P 10 23 69 00 | 2300 x 700 x 900 mm | P 10 23 79 00 |
| | 2400 x 600 x 900 mm | P 10 24 69 00 | 2400 x 700 x 900 mm | P 10 24 79 00 |
| | 2500 x 600 x 900 mm | P 10 25 69 00 | 2500 x 700 x 900 mm | P 10 25 79 00 |
| | 2600 x 600 x 900 mm | P 10 26 69 00 | 2600 x 700 x 900 mm | P 10 26 79 00 |
| | 2700 x 600 x 900 mm | P 10 27 69 00 | 2700 x 700 x 900 mm | P 10 27 79 00 |
| | 2800 x 600 x 900 mm | P 10 28 69 00 | 2800 x 700 x 900 mm | P 10 28 79 00 |
| | 2900 x 600 x 900 mm | P 10 29 69 00 | 2900 x 700 x 900 mm | P 10 29 79 00 |
| | 3000 x 600 x 900 mm | P 10 30 69 00 | 3000 x 700 x 900 mm | P 10 30 79 00 |
| | 3100 x 600 x 900 mm | P 10 31 69 00 | 3100 x 700 x 900 mm | P 10 31 79 00 |
| | 3200 x 600 x 900 mm | P 10 32 69 00 | 3200 x 700 x 900 mm | P 10 32 79 00 |
| | 3300 x 600 x 900 mm | P 10 33 69 00 | 3300 x 700 x 900 mm | P 10 33 79 00 |
| | 3400 x 600 x 900 mm | P 10 34 69 00 | 3400 x 700 x 900 mm | P 10 34 79 00 |
| | 3500 x 600 x 900 mm | P 10 35 69 00 | 3500 x 700 x 900 mm | P 10 35 79 00 |
| | 3600 x 600 x 900 mm | P 10 36 69 00 | 3600 x 700 x 900 mm | P 10 36 79 00 |
| | 3700 x 600 x 900 mm | P 10 37 69 00 | 3700 x 700 x 900 mm | P 10 37 79 00 |
| | 3800 x 600 x 900 mm | P 10 38 69 00 | 3800 x 700 x 900 mm | P 10 38 79 00 |
| | 500 x 600 x 900 mm | P 20 05 69 00 | 500 x 700 x 900 mm | P 20 05 79 00 |
| | 600 x 600 x 900 mm | P 20 06 69 00 | 600 x 700 x 900 mm | P 20 06 79 00 |
| | 700 x 600 x 900 mm | P 20 07 69 00 | 700 x 700 x 900 mm | P 20 07 79 00 |
| | 800 x 600 x 900 mm | P 20 08 69 00 | 800 x 700 x 900 mm | P 20 08 79 00 |
| | 900 x 600 x 900 mm | P 20 09 69 00 | 900 x 700 x 900 mm | P 20 09 79 00 |
| | 1000 x 600 x 900 mm | P 20 10 69 00 | 1000 x 700 x 900 mm | P 20 10 79 00 |
| | 1100 x 600 x 900 mm | P 20 11 69 00 | 1100 x 700 x 900 mm | P 20 11 79 00 |
| | 1200 x 600 x 900 mm | P 20 12 69 00 | 1200 x 700 x 900 mm | P 20 12 79 00 |
| | 1300 x 600 x 900 mm | P 20 13 69 00 | 1300 x 700 x 900 mm | P 20 13 79 00 |
| | 1400 x 600 x 900 mm | P 20 14 69 00 | 1400 x 700 x 900 mm | P 20 14 79 00 |
| | 1500 x 600 x 900 mm | P 20 15 69 00 | 1500 x 700 x 900 mm | P 20 15 79 00 |
| | 1600 x 600 x 900 mm | P 20 16 69 00 | 1600 x 700 x 900 mm | P 20 16 79 00 |
| | 1700 x 600 x 900 mm | P 20 17 69 00 | 1700 x 700 x 900 mm | P 20 17 79 00 |
| | 1800 x 600 x 900 mm | P 20 18 69 00 | 1800 x 700 x 900 mm | P 20 18 79 00 |
| | 1900 x 600 x 900 mm | P 20 19 69 00 | 1900 x 700 x 900 mm | P 20 19 79 00 |
| | 2000 x 600 x 900 mm | P 20 20 69 00 | 2000 x 700 x 900 mm | P 20 20 79 00 |
| | 2100 x 600 x 900 mm | P 20 21 69 00 | 2100 x 700 x 900 mm | P 20 21 79 00 |
| | 2200 x 600 x 900 mm | P 20 22 69 00 | 2200 x 700 x 900 mm | P 20 22 79 00 |
| | 2300 x 600 x 900 mm | P 20 23 69 00 | 2300 x 700 x 900 mm | P 20 23 79 00 |
| | 2400 x 600 x 900 mm | P 20 24 69 00 | 2400 x 700 x 900 mm | P 20 24 79 00 |
| | 2500 x 600 x 900 mm | P 20 25 69 00 | 2500 x 700 x 900 mm | P 20 25 79 00 |
| | 2600 x 600 x 900 mm | P 20 26 69 00 | 2600 x 700 x 900 mm | P 20 26 79 00 |
| | 2700 x 600 x 900 mm | P 20 27 69 00 | 2700 x 700 x 900 mm | P 20 27 79 00 |
| | 2800 x 600 x 900 mm | P 20 28 69 00 | 2800 x 700 x 900 mm | P 20 28 79 00 |
| | 2900 x 600 x 900 mm | P 20 29 69 00 | 2900 x 700 x 900 mm | P 20 29 79 00 |
| | 3000 x 600 x 900 mm | P 20 30 69 00 | 3000 x 700 x 900 mm | P 20 30 79 00 |
| | 3100 x 600 x 900 mm | P 20 31 69 00 | 3100 x 700 x 900 mm | P 20 31 79 00 |
| | 3200 x 600 x 900 mm | P 20 32 69 00 | 3200 x 700 x 900 mm | P 20 32 79 00 |
| | 3300 x 600 x 900 mm | P 20 33 69 00 | 3300 x 700 x 900 mm | P 20 33 79 00 |
| | 3400 x 600 x 900 mm | P 20 34 69 00 | 3400 x 700 x 900 mm | P 20 34 79 00 |
| | 3500 x 600 x 900 mm | P 20 35 69 00 | 3500 x 700 x 900 mm | P 20 35 79 00 |
| | 3600 x 600 x 900 mm | P 20 36 69 00 | 3600 x 700 x 900 mm | P 20 36 79 00 |
| | 3700 x 600 x 900 mm | P 20 37 69 00 | 3700 x 700 x 900 mm | P 20 37 79 00 |
| | 3800 x 600 x 900 mm | P 20 38 69 00 | 3800 x 700 x 900 mm | P 20 38 79 00 |



PACKING TABLE MODEL PR 10

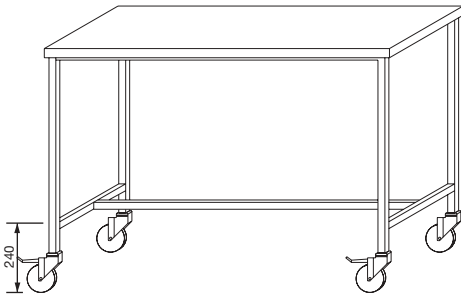

Packing table model PR 10

made of high-grade chrome nickel steel, alloy AISI 304 (1.4301), surface finished, to grain 240/320.

Smooth table top, material thickness 1.0 mm, 40 mm fold-over on all sides, underside finished in chrome nickel steel plating.

Open frame of 30 x 30 mm square tubing, with side stabilizers and central reinforcing strut.

Mobile on 4 antistatic, swivel castors, 125 mm diameter, 2 with brakes.

Total height approx. 900 mm.

| DESIGNATION | DIMENSIONS (W x D x H) | ORDER NO. |
|--|------------------------|----------------|
| Packing table model PR 10 Depth: 600 mm | 500 x 600 x 900 mm | PR 10 05 69 00 |
| | 600 x 600 x 900 mm | PR 10 06 69 00 |
| | 700 x 600 x 900 mm | PR 10 07 69 00 |
| | 800 x 600 x 900 mm | PR 10 08 69 00 |
| | 900 x 600 x 900 mm | PR 10 09 69 00 |
| | 1000 x 600 x 900 mm | PR 10 10 69 00 |
| | 1100 x 600 x 900 mm | PR 10 11 69 00 |
| | 1200 x 600 x 900 mm | PR 10 12 69 00 |
| | 1300 x 600 x 900 mm | PR 10 13 69 00 |
| | 1400 x 600 x 900 mm | PR 10 14 69 00 |
| | 1500 x 600 x 900 mm | PR 10 15 69 00 |
| | 1600 x 600 x 900 mm | PR 10 16 69 00 |
| | 1700 x 600 x 900 mm | PR 10 17 69 00 |
| Packing table model PR 10 Depth: 700 mm | 500 x 700 x 900 mm | PR 10 05 79 00 |
| | 600 x 700 x 900 mm | PR 10 06 79 00 |
| | 700 x 700 x 900 mm | PR 10 07 79 00 |
| | 800 x 700 x 900 mm | PR 10 08 79 00 |
| | 900 x 700 x 900 mm | PR 10 09 79 00 |
| | 1000 x 700 x 900 mm | PR 10 10 79 00 |
| | 1100 x 700 x 900 mm | PR 10 11 79 00 |
| | 1200 x 700 x 900 mm | PR 10 12 79 00 |
| | 1300 x 700 x 900 mm | PR 10 13 79 00 |
| | 1400 x 700 x 900 mm | PR 10 14 79 00 |
| | 1500 x 700 x 900 mm | PR 10 15 79 00 |
| | 1600 x 700 x 900 mm | PR 10 16 79 00 |
| | 1700 x 700 x 900 mm | PR 10 17 79 00 |
| Packing table model PR 10 Depth: 800 mm | 500 x 800 x 900 mm | PR 10 05 89 00 |
| | 600 x 800 x 900 mm | PR 10 06 89 00 |
| | 700 x 800 x 900 mm | PR 10 07 89 00 |
| | 800 x 800 x 900 mm | PR 10 08 89 00 |
| | 900 x 800 x 900 mm | PR 10 09 89 00 |
| | 1000 x 800 x 900 mm | PR 10 10 89 00 |
| | 1100 x 800 x 900 mm | PR 10 11 89 00 |
| | 1200 x 800 x 900 mm | PR 10 12 89 00 |
| | 1300 x 800 x 900 mm | PR 10 13 89 00 |
| | 1400 x 800 x 900 mm | PR 10 14 89 00 |
| | 1500 x 800 x 900 mm | PR 10 15 89 00 |
| | 1600 x 800 x 900 mm | PR 10 16 89 00 |
| | 1700 x 800 x 900 mm | PR 10 17 89 00 |
| Packing table model PR 10 Depth: 900 mm | 500 x 900 x 900 mm | PR 10 05 99 00 |
| | 600 x 900 x 900 mm | PR 10 06 99 00 |
| | 700 x 900 x 900 mm | PR 10 07 99 00 |
| | 800 x 900 x 900 mm | PR 10 08 99 00 |
| | 900 x 900 x 900 mm | PR 10 09 99 00 |
| | 1000 x 900 x 900 mm | PR 10 10 99 00 |
| | 1100 x 900 x 900 mm | PR 10 11 99 00 |
| | 1200 x 900 x 900 mm | PR 10 12 99 00 |
| | 1300 x 900 x 900 mm | PR 10 13 99 00 |
| | 1400 x 900 x 900 mm | PR 10 14 99 00 |
| | 1500 x 900 x 900 mm | PR 10 15 99 00 |
| | 1600 x 900 x 900 mm | PR 10 16 99 00 |
| | 1700 x 900 x 900 mm | PR 10 17 99 00 |

PACKING TABLE MODEL PR 20

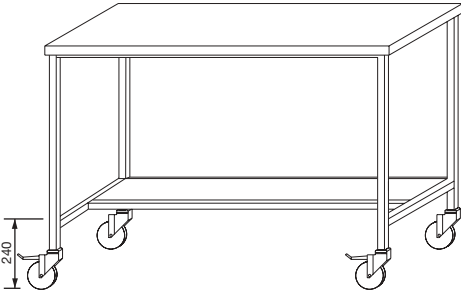
| | DESIGNATION | DIMENSIONS (W x D x H) | ORDER NO. | |
|--|--|---|--|--|
|  <p>Packing table model PR 20 made of high-grade chrome nickel steel, alloy AISI 304 (1.4301), surface finished, to grain 240/320.</p> <p>Smooth table top, material thickness 1.0 mm, 40 mm fold-over on all sides, underside finished in chrome nickel steel plating.</p> <p>Open frame of 30 x 30 mm square tubing, with side stabilizers and single-layer shelf, insert (shortened about 1/3).</p> <p>Mobile on 4 antistatic, swivel castors, 125 mm diameter, 2 with brakes.</p> <p>Total height approx. 900 mm.</p> | <p>Packing table model PR 20 Depth: 600 mm</p> | <p>500 x 600 x 900 mm 600 x 600 x 900 mm 700 x 600 x 900 mm 800 x 600 x 900 mm 900 x 600 x 900 mm 1000 x 600 x 900 mm 1100 x 600 x 900 mm 1200 x 600 x 900 mm 1300 x 600 x 900 mm 1400 x 600 x 900 mm 1500 x 600 x 900 mm 1600 x 600 x 900 mm 1700 x 600 x 900 mm 1800 x 600 x 900 mm 1900 x 600 x 900 mm 2000 x 600 x 900 mm</p> | <p>PR 20 05 69 00 PR 20 06 69 00 PR 20 07 69 00 PR 20 08 69 00 PR 20 09 69 00 PR 20 10 69 00 PR 20 11 69 00 PR 20 12 69 00 PR 20 13 69 00 PR 20 14 69 00 PR 20 15 69 00 PR 20 16 69 00 PR 20 17 69 00 PR 20 18 69 00 PR 20 19 69 00 PR 20 20 69 00</p> | |
| | <p>Packing table model PR 20 Depth: 700 mm</p> | <p>500 x 700 x 900 mm 600 x 700 x 900 mm 700 x 700 x 900 mm 800 x 700 x 900 mm 900 x 700 x 900 mm 1000 x 700 x 900 mm 1100 x 700 x 900 mm 1200 x 700 x 900 mm 1300 x 700 x 900 mm 1400 x 700 x 900 mm 1500 x 700 x 900 mm 1600 x 700 x 900 mm 1700 x 700 x 900 mm 1800 x 700 x 900 mm 1900 x 700 x 900 mm 2000 x 700 x 900 mm</p> | <p>PR 20 05 79 00 PR 20 06 79 00 PR 20 07 79 00 PR 20 08 79 00 PR 20 09 79 00 PR 20 10 79 00 PR 20 11 79 00 PR 20 12 79 00 PR 20 13 79 00 PR 20 14 79 00 PR 20 15 79 00 PR 20 16 79 00 PR 20 17 79 00 PR 20 18 79 00 PR 20 19 79 00 PR 20 20 79 00</p> | |
| | <p>Packing table model PR 20 Depth: 800 mm</p> | <p>500 x 800 x 900 mm 600 x 800 x 900 mm 700 x 800 x 900 mm 800 x 800 x 900 mm 900 x 800 x 900 mm 1000 x 800 x 900 mm 1100 x 800 x 900 mm 1200 x 800 x 900 mm 1300 x 800 x 900 mm 1400 x 800 x 900 mm 1500 x 800 x 900 mm 1600 x 800 x 900 mm 1700 x 800 x 900 mm 1800 x 800 x 900 mm 1900 x 800 x 900 mm 2000 x 800 x 900 mm</p> | <p>PR 20 05 89 00 PR 20 06 89 00 PR 20 07 89 00 PR 20 08 89 00 PR 20 09 89 00 PR 20 10 89 00 PR 20 11 89 00 PR 20 12 89 00 PR 20 13 89 00 PR 20 14 89 00 PR 20 15 89 00 PR 20 16 89 00 PR 20 17 89 00 PR 20 18 89 00 PR 20 19 89 00 PR 20 20 89 00</p> | |
| | <p>Packing table model PR 20 Depth: 900 mm</p> | <p>500 x 900 x 900 mm 600 x 900 x 900 mm 700 x 900 x 900 mm 800 x 900 x 900 mm 900 x 900 x 900 mm 1000 x 900 x 900 mm 1100 x 900 x 900 mm 1200 x 900 x 900 mm 1300 x 900 x 900 mm 1400 x 900 x 900 mm 1500 x 900 x 900 mm 1600 x 900 x 900 mm 1700 x 900 x 900 mm 1800 x 900 x 900 mm 1900 x 900 x 900 mm 2000 x 900 x 900 mm</p> | <p>PR 20 05 99 00 PR 20 06 99 00 PR 20 07 99 00 PR 20 08 99 00 PR 20 09 99 00 PR 20 10 99 00 PR 20 11 99 00 PR 20 12 99 00 PR 20 13 99 00 PR 20 14 99 00 PR 20 15 99 00 PR 20 16 99 00 PR 20 17 99 00 PR 20 18 99 00 PR 20 19 99 00 PR 20 20 99 00</p> | |

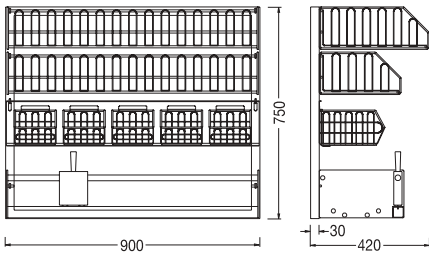
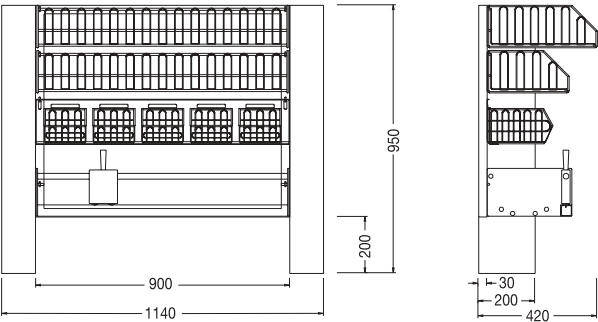
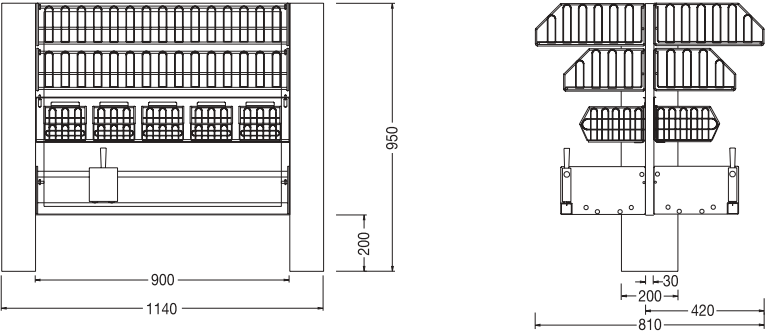

STERILE GOODS PACKING RACKS PA 900 CHROME NICKEL STEEL

| DESIGNATION | DIMENSIONS (W x D x H) | ORDER NO. | | | | | | | | | | |
|--|--|----------------------------|-------------------------------|--|--------------------------------|---------------------------|-------------------------------|-----------------------------------|---|---------------------------------------|---|---|
|  <p>Sterile goods packing rack for wall mounting</p> <p>Components:</p> <table border="0"> <tr> <td>1 x Support frame 900/750 mm</td> <td>3 x Separator grids 290 mm</td> </tr> <tr> <td>1 x Shelf rack 895/390/150 mm</td> <td>1 x Support element 900 mm for wire baskets</td> </tr> <tr> <td>3 x Separator grids 390 mm</td> <td>5 x Wire baskets, size 4</td> </tr> <tr> <td>1 x Shelf rack 895/290/150 mm</td> <td>1 x Roll rack with cutter 900 mm</td> </tr> </table> <p>like above but without roll rack / cutter</p> | 1 x Support frame 900/750 mm | 3 x Separator grids 290 mm | 1 x Shelf rack 895/390/150 mm | 1 x Support element 900 mm for wire baskets | 3 x Separator grids 390 mm | 5 x Wire baskets, size 4 | 1 x Shelf rack 895/290/150 mm | 1 x Roll rack with cutter 900 mm | <p>900 x 420 x 750 mm</p> <p>900 x 420 x 750 mm</p> | <p>PA 900-01 W</p> <p>PA 900-05 W</p> | | |
| 1 x Support frame 900/750 mm | 3 x Separator grids 290 mm | | | | | | | | | | | |
| 1 x Shelf rack 895/390/150 mm | 1 x Support element 900 mm for wire baskets | | | | | | | | | | | |
| 3 x Separator grids 390 mm | 5 x Wire baskets, size 4 | | | | | | | | | | | |
| 1 x Shelf rack 895/290/150 mm | 1 x Roll rack with cutter 900 mm | | | | | | | | | | | |
|  <p>Sterile goods packing rack for tabletop mounting, unilateral</p> <p>Components:</p> <table border="0"> <tr> <td>1 x Pair of support columns 120/200/950 mm</td> <td>3 x Separator grids 290 mm</td> </tr> <tr> <td>1 x Support frame 900/750 mm</td> <td>1 x Support element 900 mm for wire baskets</td> </tr> <tr> <td>1 x Shelf rack 895/390/150 mm</td> <td>5 x Wire baskets, size 4</td> </tr> <tr> <td>3 x Separator grids 390 mm</td> <td>1 x Roll rack with cutter 900 mm</td> </tr> <tr> <td>1 x Shelf rack 895/290/150 mm</td> <td></td> </tr> </table> <p>like above but without roll rack / cutter</p> | 1 x Pair of support columns 120/200/950 mm | 3 x Separator grids 290 mm | 1 x Support frame 900/750 mm | 1 x Support element 900 mm for wire baskets | 1 x Shelf rack 895/390/150 mm | 5 x Wire baskets, size 4 | 3 x Separator grids 390 mm | 1 x Roll rack with cutter 900 mm | 1 x Shelf rack 895/290/150 mm | | <p>1140 x 420 x 950 mm</p> <p>1140 x 420 x 950 mm</p> | <p>PA 900-01 T</p> <p>PA 900-05 T</p> |
| 1 x Pair of support columns 120/200/950 mm | 3 x Separator grids 290 mm | | | | | | | | | | | |
| 1 x Support frame 900/750 mm | 1 x Support element 900 mm for wire baskets | | | | | | | | | | | |
| 1 x Shelf rack 895/390/150 mm | 5 x Wire baskets, size 4 | | | | | | | | | | | |
| 3 x Separator grids 390 mm | 1 x Roll rack with cutter 900 mm | | | | | | | | | | | |
| 1 x Shelf rack 895/290/150 mm | | | | | | | | | | | | |
|  <p>Sterile goods packing rack for tabletop mounting, bilateral</p> <p>Components:</p> <table border="0"> <tr> <td>1 x Pair of support columns 120/200/950 mm</td> <td>6 x Separator grids 290 mm</td> </tr> <tr> <td>1 x Support frame 900/750 mm</td> <td>2 x Support elements 900 mm for wire baskets</td> </tr> <tr> <td>2 x Shelf racks 895/390/150 mm</td> <td>10 x Wire baskets, size 4</td> </tr> <tr> <td>6 x Separator grids 390 mm</td> <td>2 x Roll racks with cutter 900 mm</td> </tr> <tr> <td>2 x Shelf racks 895/290/150 mm</td> <td></td> </tr> </table> <p>like above but without roll rack / cutter</p> | 1 x Pair of support columns 120/200/950 mm | 6 x Separator grids 290 mm | 1 x Support frame 900/750 mm | 2 x Support elements 900 mm for wire baskets | 2 x Shelf racks 895/390/150 mm | 10 x Wire baskets, size 4 | 6 x Separator grids 390 mm | 2 x Roll racks with cutter 900 mm | 2 x Shelf racks 895/290/150 mm | | <p>1140 x 810 x 950 mm</p> <p>1140 x 810 x 950 mm</p> | <p>PA 900-01 TD</p> <p>PA 900-05 TD</p> |
| 1 x Pair of support columns 120/200/950 mm | 6 x Separator grids 290 mm | | | | | | | | | | | |
| 1 x Support frame 900/750 mm | 2 x Support elements 900 mm for wire baskets | | | | | | | | | | | |
| 2 x Shelf racks 895/390/150 mm | 10 x Wire baskets, size 4 | | | | | | | | | | | |
| 6 x Separator grids 390 mm | 2 x Roll racks with cutter 900 mm | | | | | | | | | | | |
| 2 x Shelf racks 895/290/150 mm | | | | | | | | | | | | |

STERILE GOODS PACKING RACKS PA 1200
CHROME NICKEL STEEL

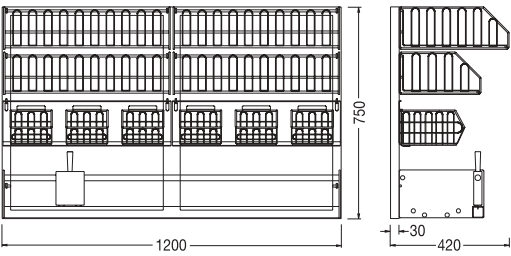
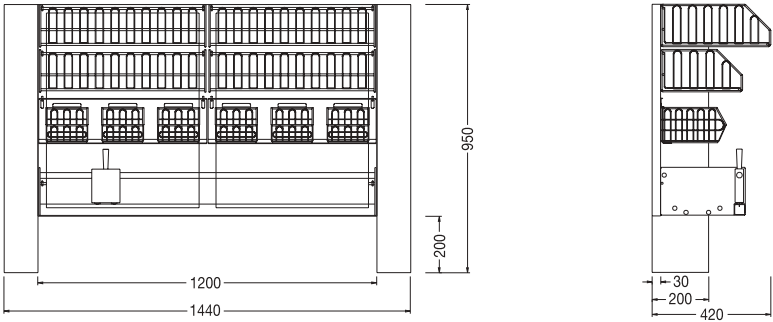
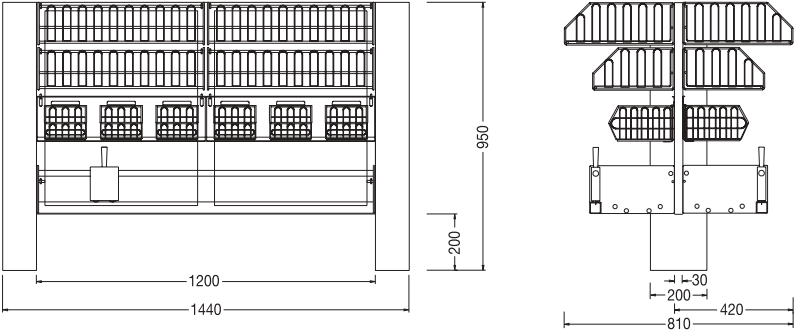

| DESIGNATION | DIMENSIONS (W x D x H) | ORDER NO. |
|--|---|---|
|  <p>Sterile goods packing rack for wall mounting Components: 1 x Support frame 1200/750 mm 2 x Shelf racks 595/390/150 mm 4 x Separator grids 390 mm 2 x Shelf racks 595/290/150 mm 4 x Separator grids 290 mm 2 x Support elements 600 mm for wire baskets 6 x Wire baskets, size 4 1 x Roll rack with cutter 1200 mm</p> <p>like above but without roll rack / cutter</p> | <p>1200 x 420 x 750 mm</p> <p>1200 x 420 x 750 mm</p> | <p>PA 1200-01 W</p> <p>PA 1200-05 W</p> |
|  <p>Sterile goods packing rack for tabletop mounting, unilateral Components: 1 x Pair of support columns 120/200/950 mm 1 x Support frame 1200/750 mm 2 x Shelf racks 595/390/150 mm 4 x Separator grids 390 mm 2 x Shelf racks 595/290/150 mm 4 x Separator grids 290 mm 2 x Support elements 600 mm for wire baskets 6 x Wire baskets, size 4 1 x Roll rack with cutter 1200 mm</p> <p>like above but without roll rack / cutter</p> | <p>1440 x 420 x 950 mm</p> <p>1440 x 420 x 950 mm</p> | <p>PA 1200-01 T</p> <p>PA 1200-05 T</p> |
|  <p>Sterile goods packing rack for tabletop mounting, bilateral Components: 1 x Pair of support columns 120/200/950 mm 1 x Support frame 1200/750 mm 4 x Shelf racks 595/390/150 mm 8 x Separator grids 390 mm 4 x Shelf racks 595/290/150 mm 4 x Support elements 600 mm for wire baskets 12 x Wire baskets, size 4 2 x Roll racks with cutter 1200 mm</p> <p>like above but without roll rack / cutter</p> | <p>1440 x 810 x 950 mm</p> <p>1440 x 810 x 950 mm</p> | <p>PA 1200-01 TD</p> <p>PA 1200-05 TD</p> |

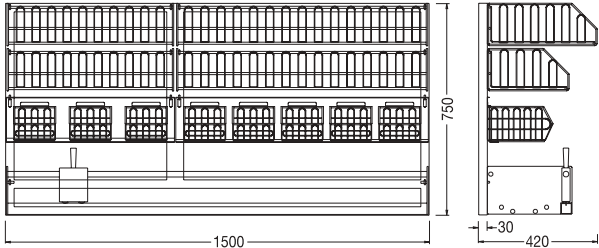
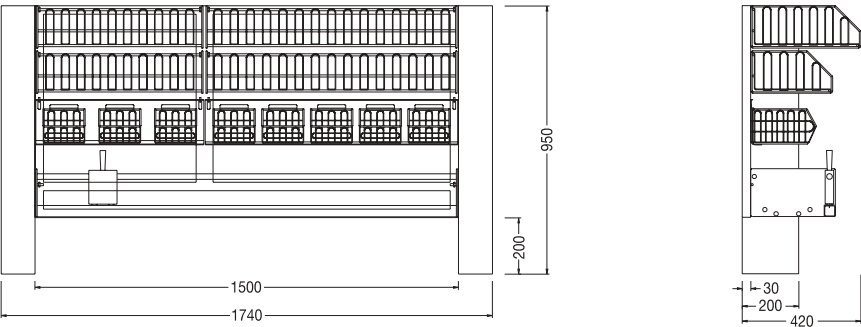
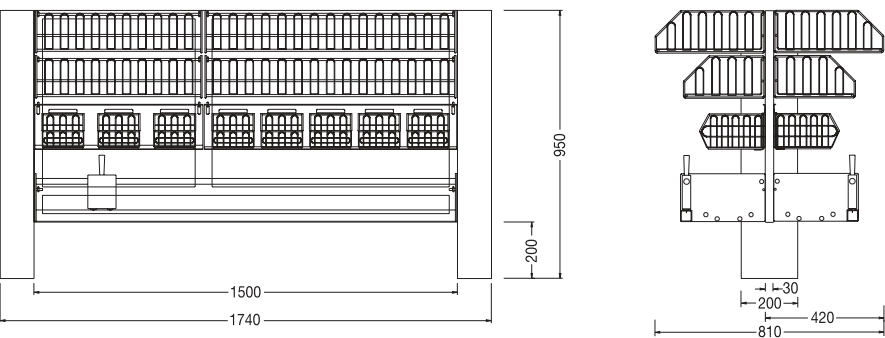

STERILE GOODS PACKING RACKS PA 1500
CHROME NICKEL STEEL

| DESIGNATION | DIMENSIONS (W x D x H) | ORDER NO. | | | | | | | | | | | | |
|---|--|--------------------------------|-------------------------------|-----------------------------|--------------------------------|--|--------------------------------|--|-------------------------------|---------------------------|--------------------------------|------------------------------------|---|---|
|  <p>Sterile goods packing rack for wall mounting</p> <p>Components:</p> <table border="0"> <tr> <td>1 x Support frame 1500/750 mm</td> <td>1 x Shelf rack 595/290/150 mm</td> </tr> <tr> <td>1 x Shelf rack 895/390/150 mm</td> <td>5 x Separator grids 290 mm</td> </tr> <tr> <td>1 x Shelf rack 595/390/150 mm</td> <td>1 x Support element 900 mm for wire baskets</td> </tr> <tr> <td>5 x Separator grids 390 mm</td> <td>1 x Support element 600 mm for wire baskets</td> </tr> <tr> <td>1 x Shelf rack 895/290/150 mm</td> <td>8 x Wire baskets, size 4</td> </tr> <tr> <td></td> <td>1 x Roll rack with cutter 1500 mm</td> </tr> </table> <p>like above but without roll rack / cutter</p> | 1 x Support frame 1500/750 mm | 1 x Shelf rack 595/290/150 mm | 1 x Shelf rack 895/390/150 mm | 5 x Separator grids 290 mm | 1 x Shelf rack 595/390/150 mm | 1 x Support element 900 mm for wire baskets | 5 x Separator grids 390 mm | 1 x Support element 600 mm for wire baskets | 1 x Shelf rack 895/290/150 mm | 8 x Wire baskets, size 4 | | 1 x Roll rack with cutter 1500 mm | <p>1500 x 420 x 750 mm</p> <p>1500 x 420 x 750 mm</p> | <p>PA 1500-01 W</p> <p>PA 1500-05 W</p> |
| 1 x Support frame 1500/750 mm | 1 x Shelf rack 595/290/150 mm | | | | | | | | | | | | | |
| 1 x Shelf rack 895/390/150 mm | 5 x Separator grids 290 mm | | | | | | | | | | | | | |
| 1 x Shelf rack 595/390/150 mm | 1 x Support element 900 mm for wire baskets | | | | | | | | | | | | | |
| 5 x Separator grids 390 mm | 1 x Support element 600 mm for wire baskets | | | | | | | | | | | | | |
| 1 x Shelf rack 895/290/150 mm | 8 x Wire baskets, size 4 | | | | | | | | | | | | | |
| | 1 x Roll rack with cutter 1500 mm | | | | | | | | | | | | | |
|  <p>Sterile goods packing rack for tabletop mounting, unilateral</p> <p>Components:</p> <table border="0"> <tr> <td>1 x Pair of support columns 120/200/950 mm</td> <td>1 x Shelf rack 595/290/150 mm</td> </tr> <tr> <td>1 x Support frame 1500/750 mm</td> <td>5 x Separator grids 290 mm</td> </tr> <tr> <td>1 x Shelf rack 895/390/150 mm</td> <td>1 x Support element 900 mm for wire baskets</td> </tr> <tr> <td>1 x Shelf rack 595/390/150 mm</td> <td>1 x Support element 600 mm for wire baskets</td> </tr> <tr> <td>5 x Separator grids 390 mm</td> <td>8 x Wire baskets, size 4</td> </tr> <tr> <td>1 x Shelf rack 895/290/150 mm</td> <td>1 x Roll rack with cutter 1500 mm</td> </tr> </table> <p>like above but without roll rack / cutter</p> | 1 x Pair of support columns 120/200/950 mm | 1 x Shelf rack 595/290/150 mm | 1 x Support frame 1500/750 mm | 5 x Separator grids 290 mm | 1 x Shelf rack 895/390/150 mm | 1 x Support element 900 mm for wire baskets | 1 x Shelf rack 595/390/150 mm | 1 x Support element 600 mm for wire baskets | 5 x Separator grids 390 mm | 8 x Wire baskets, size 4 | 1 x Shelf rack 895/290/150 mm | 1 x Roll rack with cutter 1500 mm | <p>1740 x 420 x 950 mm</p> <p>1740 x 420 x 950 mm</p> | <p>PA 1500-01 T</p> <p>PA 1500-05 T</p> |
| 1 x Pair of support columns 120/200/950 mm | 1 x Shelf rack 595/290/150 mm | | | | | | | | | | | | | |
| 1 x Support frame 1500/750 mm | 5 x Separator grids 290 mm | | | | | | | | | | | | | |
| 1 x Shelf rack 895/390/150 mm | 1 x Support element 900 mm for wire baskets | | | | | | | | | | | | | |
| 1 x Shelf rack 595/390/150 mm | 1 x Support element 600 mm for wire baskets | | | | | | | | | | | | | |
| 5 x Separator grids 390 mm | 8 x Wire baskets, size 4 | | | | | | | | | | | | | |
| 1 x Shelf rack 895/290/150 mm | 1 x Roll rack with cutter 1500 mm | | | | | | | | | | | | | |
|  <p>Sterile goods packing rack for tabletop mounting, bilateral</p> <p>Components:</p> <table border="0"> <tr> <td>1 x Pair of support columns 120/200/950 mm</td> <td>2 x Shelf racks 595/290/150 mm</td> </tr> <tr> <td>1 x Support frame 1500/750 mm</td> <td>10 x Separator grids 290 mm</td> </tr> <tr> <td>2 x Shelf racks 895/390/150 mm</td> <td>2 x Support elements 900 mm for wire baskets</td> </tr> <tr> <td>2 x Shelf racks 595/390/150 mm</td> <td>2 x Support elements 600 mm for wire baskets</td> </tr> <tr> <td>10 x Separator grids 390 mm</td> <td>16 x Wire baskets, size 4</td> </tr> <tr> <td>2 x Shelf racks 895/290/150 mm</td> <td>2 x Roll racks with cutter 1500 mm</td> </tr> </table> <p>like above but without roll rack / cutter</p> | 1 x Pair of support columns 120/200/950 mm | 2 x Shelf racks 595/290/150 mm | 1 x Support frame 1500/750 mm | 10 x Separator grids 290 mm | 2 x Shelf racks 895/390/150 mm | 2 x Support elements 900 mm for wire baskets | 2 x Shelf racks 595/390/150 mm | 2 x Support elements 600 mm for wire baskets | 10 x Separator grids 390 mm | 16 x Wire baskets, size 4 | 2 x Shelf racks 895/290/150 mm | 2 x Roll racks with cutter 1500 mm | <p>1740 x 810 x 950 mm</p> <p>1740 x 810 x 950 mm</p> | <p>PA 1500-01 TD</p> <p>PA 1500-05 TD</p> |
| 1 x Pair of support columns 120/200/950 mm | 2 x Shelf racks 595/290/150 mm | | | | | | | | | | | | | |
| 1 x Support frame 1500/750 mm | 10 x Separator grids 290 mm | | | | | | | | | | | | | |
| 2 x Shelf racks 895/390/150 mm | 2 x Support elements 900 mm for wire baskets | | | | | | | | | | | | | |
| 2 x Shelf racks 595/390/150 mm | 2 x Support elements 600 mm for wire baskets | | | | | | | | | | | | | |
| 10 x Separator grids 390 mm | 16 x Wire baskets, size 4 | | | | | | | | | | | | | |
| 2 x Shelf racks 895/290/150 mm | 2 x Roll racks with cutter 1500 mm | | | | | | | | | | | | | |

STERILE GOODS PACKING RACKS PA 1800
CHROME NICKEL STEEL

BECKER

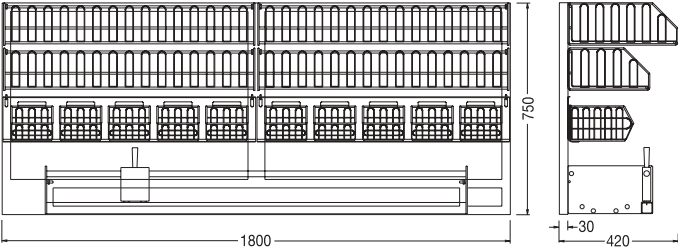
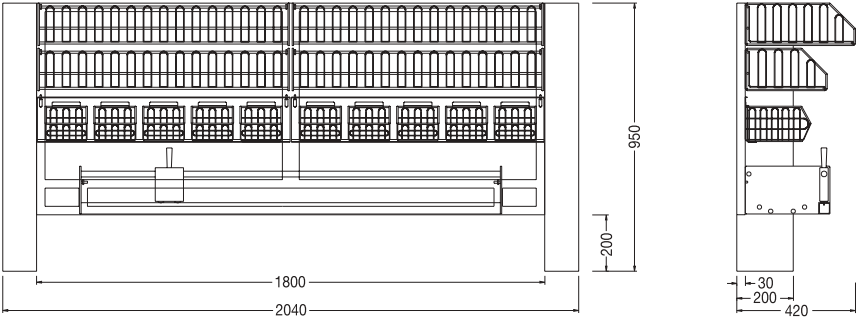
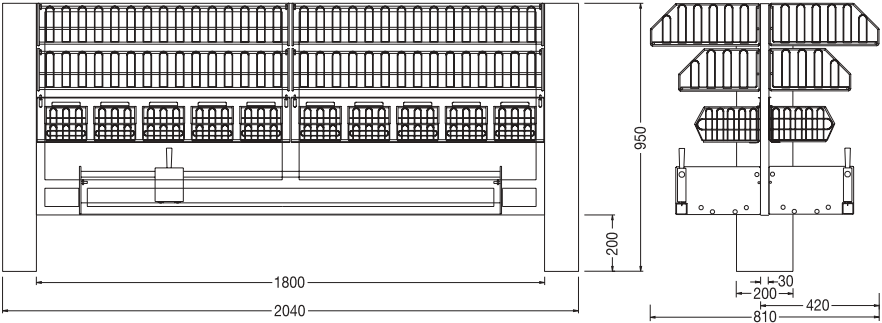
| DESIGNATION | DIMENSIONS (W x D x H) | ORDER NO. |
|--|---|---|
|  <p>Sterile goods packing rack for wall mounting Components: 1 x Support frame 1800/750 mm 2 x Shelf racks 895/390/150 mm 6 x Separator grids 390 mm 2 x Shelf racks 895/290/150 mm 6 x Separator grids 290 mm 2 x Support elements 900 mm for wire baskets 10 x Wire baskets, size 4 1 x Roll rack with cutter 1500 mm</p> <p>like above but without roll rack / cutter</p> | <p>1800 x 420 x 750 mm</p> <p>1800 x 420 x 750 mm</p> | <p>PA 1800-03 W</p> <p>PA 1800-05 W</p> |
|  <p>Sterile goods packing rack for tabletop mounting, unilateral Components: 1 x Pair of support columns 120/200/950 mm 1 x Support frame 1800/750 mm 2 x Shelf racks 895/390/150 mm 6 x Separator grids 390 mm 2 x Shelf racks 895/290/150 mm 6 x Separator grids 290 mm 2 x Support elements 900 mm for wire baskets 10 x Wire baskets, size 4 1 x Roll rack with cutter 1500 mm</p> <p>like above but without roll rack / cutter</p> | <p>2040 x 420 x 950 mm</p> <p>2040 x 420 x 950 mm</p> | <p>PA 1800-03 T</p> <p>PA 1800-05 T</p> |
|  <p>Sterile goods packing rack for tabletop mounting, bilateral Components: 1 x Pair of support columns 120/200/950 mm 1 x Support frame 1800/750 mm 4 x Shelf racks 895/390/150 mm 12 x Separator grids 390 mm 4 x Shelf racks 895/290/150 mm 12 x Separator grids 290 mm 4 x Support elements 900 mm for wire baskets 20 x Wire baskets, size 4 2 x Roll racks with cutter 1500 mm</p> <p>like above but without roll rack / cutter</p> | <p>2040 x 810 x 950 mm</p> <p>2040 x 810 x 950 mm</p> | <p>PA 1800-03 TD</p> <p>PA 1800-05 TD</p> |

BECKER



Becker quality steel furniture and equipment have been in use in hospitals and medical centers for decades. Optimum use of available space is achieved through an extensive line of programmes and sizes.

Special designs and individual choice of colors as well as custom-built systems offer an enormous variety of options to the customer.

**Metallwarenfabrik
Walter H. Becker GmbH
Anzenkirchener Straße 4
D-84371 Triftern**

**Tel.: +49 (0) 85 62 / 96 05-0
Fax: +49 (0) 85 62 / 24 34
E-mail: becker.triftern@t-online.de
Internet: www.becker-triftern.de**

BECKER SYSTEMS for:

**wards
out-patient departments
operating rooms
treatment rooms
sterilization**