

Living up to Life

Leica
MICROSYSTEMS



Leica DM4000–6000 B

Brilliant, Easy Imaging at the Speed of Light!
Brilliant discoveries with the new generation
of DigitalMicroscopes for biological sciences



Brilliant discoveries ... this is why you entered science.

It's what you work for every day.

The new generation of Leica DigitalMicroscopes will help you make your next brilliant discovery.

Brilliant, Easy Imaging at the Speed of Light

The Leica DigitalMicroscope family

Leica Microsystems developed the Leica DigitalMicroscope family based on feedback from the research community. In particular, Leica responds to the fact that researchers want a microscope that requires less time-consuming adjustment. Leica DigitalMicroscopes address this need in a variety of ways. The ability to automate complex experiment sequences saves valuable time during research.

Proven, high-quality optics

For more than one hundred years Leica Microsystems has been at the forefront of optical technology, and Leica optics are renowned for their high quality. Leica's proven quality is one reason why our customers do not want to use any other brand. No microscope in this class can offer better image brilliance, depth of focus, and contrast.

Innovative design

At first glance: a clean, attractive design and logically-placed controls. Leica DigitalMicroscopes are manufactured using top quality materials to provide a microscope that supports research over the long term.

User-friendly through ergonomics

Ergonomics is a word often associated with ease of use. With Leica DigitalMicroscopes, ergonomic design means a user-friendly microscope system that the researcher can actually feel. Working closely with the Fraunhofer Institute*, Leica designed these microscopes to not only exceed the latest technical standards, but also to meet the highest standards of ergonomic design.

** The Fraunhofer Institute IAO (Stuttgart, Germany) investigates the ergonomic qualities of various products. Working together with their partners in industry, the Fraunhofer Institute develops industrial designs that meet the highest ergonomic standards.



Leica Design by Christophe Apothéoz

Ease of Use ... Benefits Your Work

Leica DigitalMicroscopes are known for their easy, fast methods of achieving excellent results. Intelligent, reliable automation and ease-of-use down to the smallest detail enable the researcher to concentrate completely on the experiment and not on complex microscope adjustments.

Convenient, intuitive control of the microscope

The large, logically arranged display of the Leica DM4000 B LED shows all microscope settings at a glance – a convenience unmatched in this microscope class. The Leica SmartTouch touchscreen, which is integrated within the microscope stand, controls the Leica DM5000 B through DM6000 B conveniently and intuitively.

Supports a variety of control methods

The new, external Leica STP6000 SmartTouch Panel offers a new level of operational freedom to the researcher. All automated microscope functions can be conveniently and intuitively set from anywhere within the workspace via the external control, which provides the same graphical user interface as Leica Application Suite (LAS) software. Also, the Leica SmartTouch Panel offers a

focus wheel for fine and coarse adjustment, controls for x, y stage adjustment, and eleven programmable function buttons. This allows easy and convenient control of all functions using one module. Alternatively, the user can control all three axes of the microscope (x and y: stage; z: focus) with the Leica SmartMove remote control and program four function buttons to control additional microscope functions.

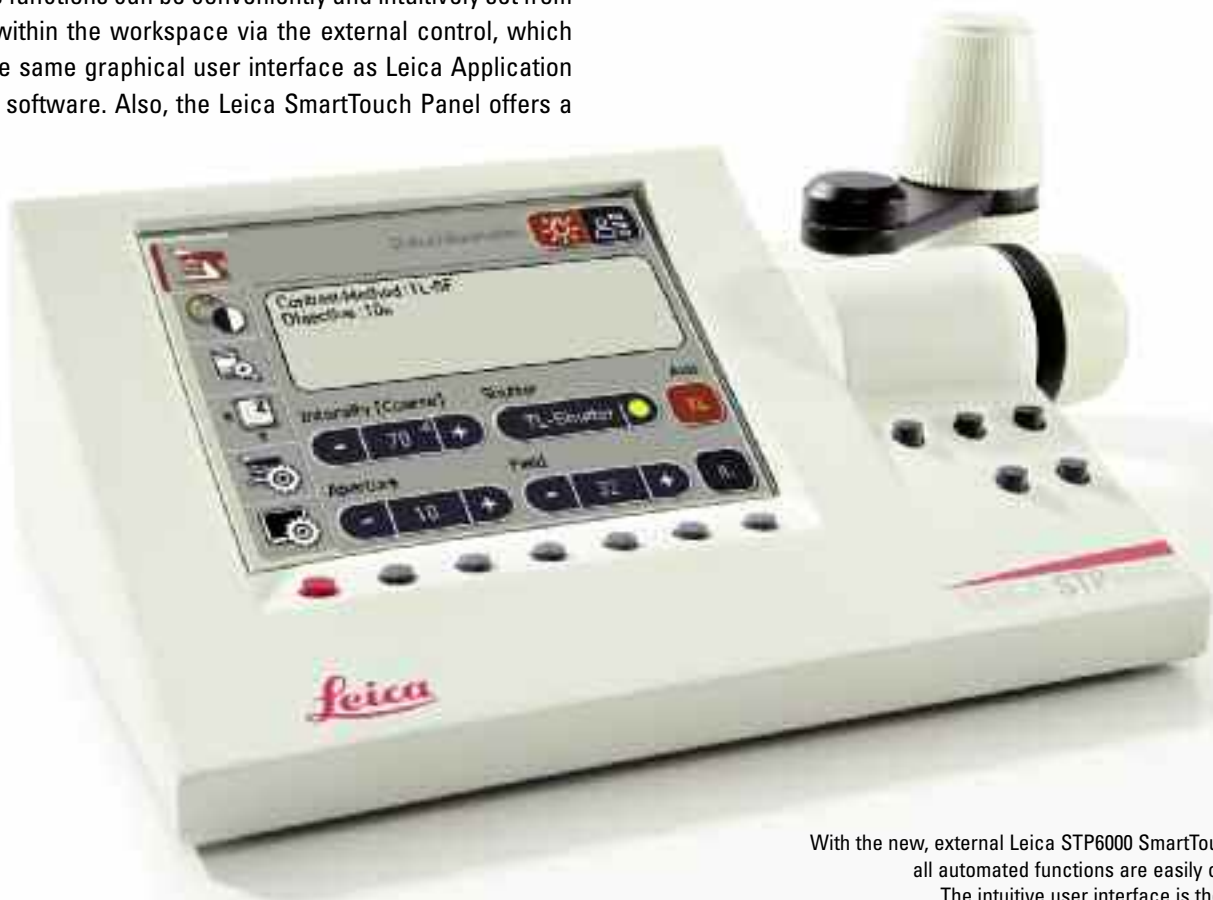

With the new, external Leica STP6000 SmartTouch Panel, all automated functions are easily controlled. The intuitive user interface is the same as that of Leica Application Suite (LAS) software.

Constant color temperature with LED illumination

With the new Leica DM4000 B LED, the transmitted light LED illumination provides constant color temperature at all light intensity levels.

One-of-a-kind: Leica's Constant Color Intensity Control* (CCIC)

The Leica transmitted light axis of DM5000-6000 B operates with an automated Constant Color Intensity Control, which maintains a constant color temperature. The white balance that is normally required for digital camera use is now a thing of the past.

Condensers provide a new level of automation

Leica's motorized condenser heads automatically swing in and out, depending on the objective in use. The automated condenser turret offers brightfield and darkfield positions and also four additional positions for ring lights and prisms for interference contrast.

Easily accessible, programmable function buttons

The user can easily assign microscope functions to the function buttons. The six buttons, located behind the focus knobs, are ideal for frequently used functions. The user can program these buttons to perform any desired function, and they are easily accessed without having to look away from the specimen. Additional programmable function buttons are located on the external Leica STP6000 SmartTouch Panel control or on the Leica SmartMove remote control.

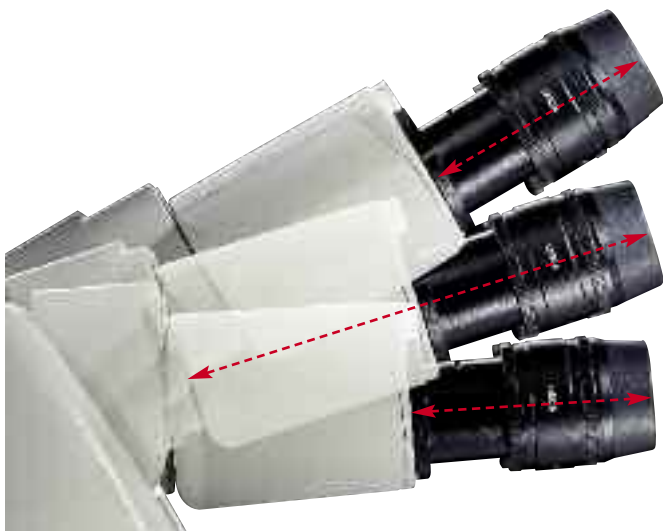

Leica's AET22 adaptable tube with its variable eyepiece extension can be specifically adjusted to the user's seated height.

• Intelligent automation means flexibility:

- Select the contrast and light manager, and automatically save the correct optical components and brightness and diaphragm settings for the objective and contrast in use – reproducible results are easy to achieve.
- All illumination settings can be individually modified for maximum flexibility.
- Assign the objective stage speed and section size of the z-focus (option).
- Intelligent automation and new codings for the objective turret make the microscope fast and reliable.

Leica DigitalMicroscopes adapt to the user in every way

Leica's AET22 adaptable, ergonomic tube adapts perfectly to the user's seated height and posture. The adaptable stage makes simultaneous focus and movement control easy and promotes a relaxed body position – even after hours of work at the microscope.

* Patented DE 101 32 360; patent applied for EP 1273953H1; Japan pat. pend. JP 2002/195868; US patent 7,027,238



Any desired microscope function can be assigned to the programmable function buttons.

Intelligent Automation Makes Work at the Mic

Transmitted light

Work at the microscope was never this efficient

Place the specimen on the microscope stage, focus, and it is ready to be viewed. The Leica DigitalMicroscope detects the selected objective in use; automatically adjusts the condenser head, aperture, and field diaphragm; and adjusts the light intensity.

No need to worry about phase contrast rings again

The Leica DigitalMicroscope knows the correct ring light for the selected objective. The aperture diaphragm is fully opened, automatically, for the perfect phase contrast.

One-of-a-kind: fully automated DIC

The Leica DM5000 B through DM6000 B microscopes feature fully automated differential interference contrast (DIC). The correct objective and condenser prisms – and polarizer and analyzer – automatically move into the beam path. One-of-a-kind: fine adjustments for the objective prisms are saved for every objective, and these settings can be reproduced at any time.

All contrast methods are automated – including darkfield and polarization

All other contrast methods, such as darkfield and polarization, are also automated. The microscope adjusts all of the required components for each contrast method.

Change contrast with the press of a button – never so easy

Leica's method of changing contrast techniques is unique. One press of the function button is all it takes to switch the microscope between brightfield, phase contrast, polarization, darkfield or fluorescence. Select interference contrast by pressing one button, which is located on the stand of the Leica DM5000 B through DM6000 B microscope.

Microscope Efficient

Fluorescence

High quality fluorescence

The fluorescence axis provides excellent, highly contrasted results. The Leica DM4000 B LED microscope can be outfit with a turret for up to five fluorescence filter cubes. An 8-cube turret is also available for the Leica DM5000 B through DM6000 B. Leica's unique Zero Pixel Shift filter cube technology ensures perfect image alignment of multiple fluorescence proteins, which makes software overlay compensation unnecessary.

A disk like no other

This all-round genius is hidden in the heart of the fluorescence axis. Leica Microsystems engineers have placed on one small disk the fluorescence intensity manager (FIM), the fast shutter that interrupts the fluorescence emitter in less than 0.1 seconds, the motorized Excitation Manager, and the fast Internal Filter Wheel (IFW).

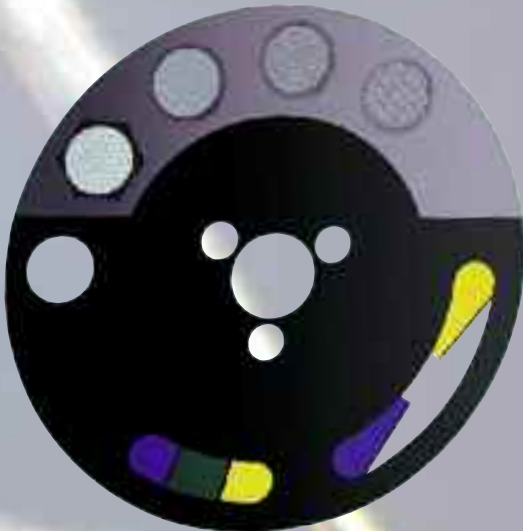

Always in the right light – with FIM* and fluo booster

Leica's FIM provides fast, accurate, and reproducible regulation of the excitation light to effectively protect the specimen from photo bleaching. Light intensity can be reduced in four fixed steps by a press of the button – absolutely reproducible. If more fluorescence light is needed, simply switch the fluo booster into the beam path. The booster lens immediately increases the fluorescence by 30%.

More options –

Excitation Manager** and internal filter wheel

The motorized Leica Excitation Manager can display multiple fluorescences. The intensity of different wavelengths can be adjusted, and the fine coding ensures absolutely reproducible results. In combination with Leica's fast internal filter wheel (IFW), this opens up new options in fluorescence microscopy.

Motorized shutter for immediate darkness

The motorized fluorescence shutter effectively protects the specimen. This is automated if required for a time-lapse application, but it can also be manually operated at any time. Leica's transmitted light axis is also outfit with a motorized shutter that can be operated separately.

* Patented US 7,379,238

** Patented CN 1162728; JP 3746195; US 6,747,280; EP 1 141 764

Integrated System Solutions for Specific Appli

An integrated imaging system gives the best results if all components seamlessly integrate together. Leica Microsystems offers a complete imaging system from one source: microscope, camera, and software – customized and perfectly matched to work together.

Adaptable software

Leica offers a modular software package that can be added to at any time to suit individual applications: Leica Application Suite (LAS). Future Leica microscope software and hardware components will continue to be controlled using this intuitive user interface.

Microscope, camera, and software – seamlessly integrated

Every Leica DigitalMicroscope system is configured with LAS software, which perfectly integrates with the microscope and camera controls. LAS software provides an intuitively-operated tool for simple documentation of experiment results. In addition, all microscope and camera parameters can be quickly and easily saved along with the images, and later retrieved. LAS software, the integrated Leica SmartTouch and the external Leica STP6000 SmartTouch Panel share the same intuitive, menu-guided controls.

Individually customizable and expandable at any time

The microscope's function buttons, contrast methods, and other settings are easily configured via PC. The LAS concept is modular, flexible, and easy to expand to suit specific needs or to meet the requirements for new applications or new projects.

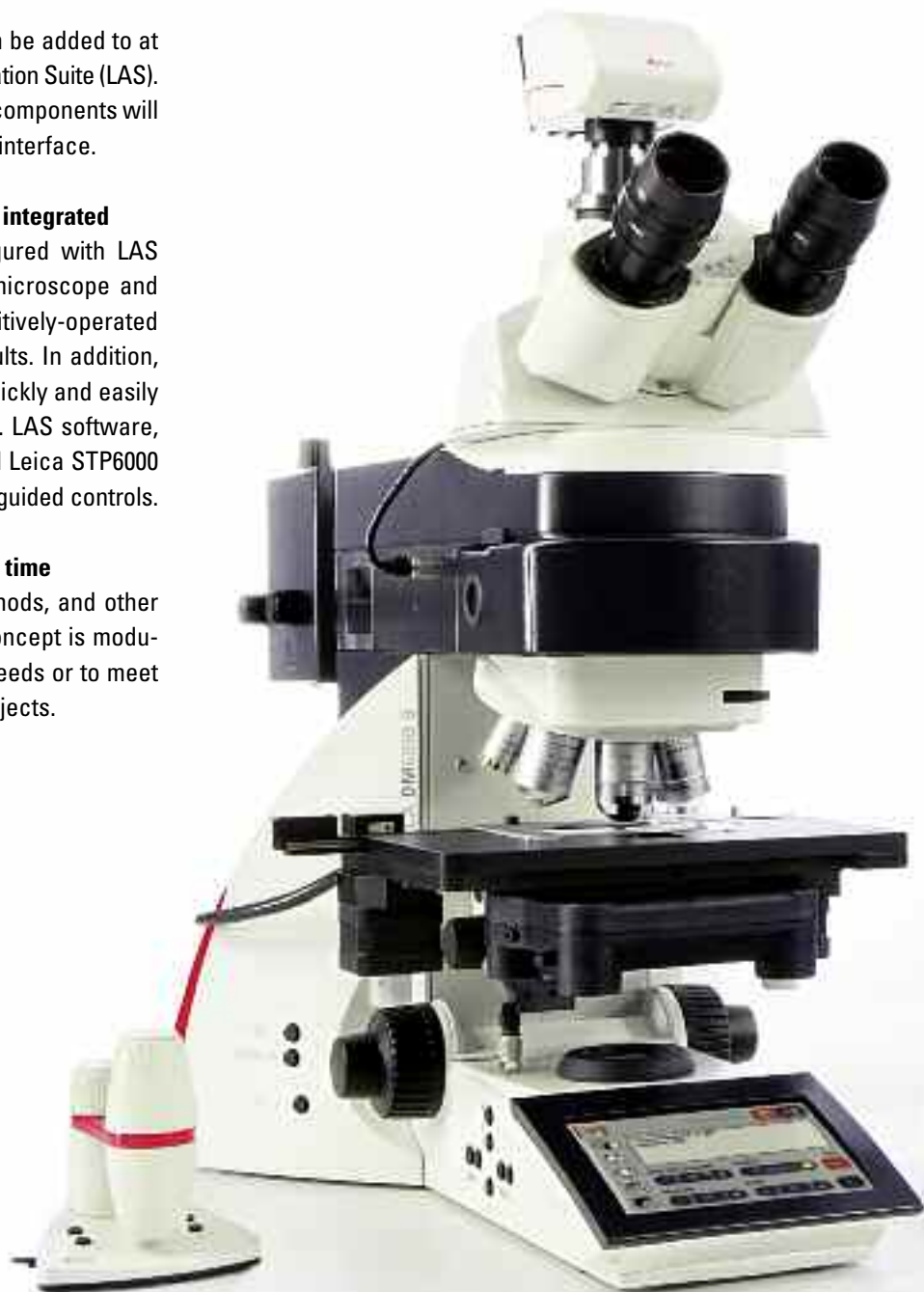

cations

Digital Cameras for every requirement

The new Leica DigitalMicroscopes provide the ideal imaging solution for every application. Images can be quickly and easily transferred to the computer via a standard FireWire interface. The range of imaging options extends from color or black and white scans for all medical and biological applications up to longer scans with several minutes of exposure time for fluorescence microscopy with low light intensity.

Outstanding system solutions

Leica has developed LAS AF6000 software as part of a perfectly harmonized microscope, camera, and software system specifically for sophisticated fluorescence applications. Ultra fast, multi-dimensional fluorescence scans; deconvolution; and 3D views are examples of LAS AF6000 applications. The user-friendly LAS AF6000 can be operated on both light microscope and confocal systems.

- **LAS software for fast and reliable results:**
 - Configure and control the camera and microscope at the same time.
 - Additional modules are available for future applications
- **LAS AF6000 for sophisticated fluorescence applications:**
 - Well-designed system solution for very fast, multidimensional fluorescence scans and processing

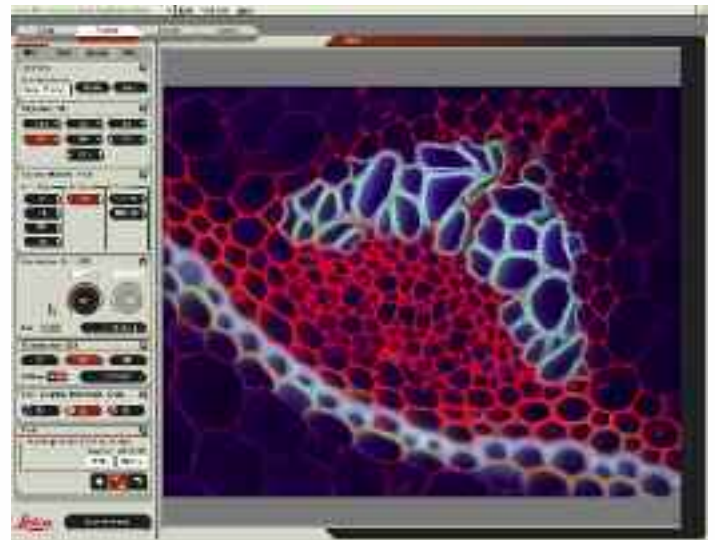

LAS (Leica Application Suite) software is easy to use and flexible enough to add to at any time



The New Generation of the DM Series in Over

New: Leica DM4000 B LED

The ideal microscope for the biological laboratory

- LED transmitted light illumination provides constant color temperature at all light intensity levels
- Intelligent automation for intuitive operation and reproducible results
- Modular design; can be customized for specific applications
- Fully automated transmitted light axis for common contrast methods: brightfield, darkfield, phase contrast, and polarization contrast
- Motorized fluorescence axis with 5-position filter cube turret
- Leica's unique fluorescence intensity manager (FIM) for fast, accurate, and reproducible adjustment of fluorescence lighting
- Manual z-drive and mechanical stage
- Fast, reliable control functions save time while working at the microscope
- Large, logical display of all settings at a glance
- Manual 6 or 7-position objective turret with absolute coding provides fast adjustment of optimal settings

Leica DM5000 B

The automated microscope for life science research

- The automated, intuitive Leica DM5000 B is easy to operate
- The settings, which can be saved and restored at any time, ensure reproducible results
- Automated transmitted light axis for all known transmitted light techniques, including Leica's unique, fully automated DIC
- Motorized fluorescence axis with 5 or 8-position filter cube turret
- Leica's unique fluorescence intensity manager (FIM) for fast, accurate, and reproducible adjustment of fluorescence lighting
- Motorized Excitation Manager and fast internal filter wheel (IFW) for multiple fluorescences
- Manual, absolute-coded, 7-position objective turret provides fast adjustment of optimal settings
- Convenient Leica SmartTouch touchscreen for controlling the automated modules
- Optional, external Leica STP6000 SmartTouch Panel for intuitive, convenient remote control of the microscope



Leica DM5500 B

The powerful, automated microscope system for life science research

- The Leica DM5500 B offers a motorized z-focus drive in addition to all the functions of the DM5000 B
- Automated parfocal compensation and saving of focus positions
- Ideal for time-lapse and z-stack experiments
- Automated transmitted light axis, including Leica's unique, fully automated DIC
- Motorized fluorescence axis with 5 or 8-position filter cube turret
- Leica's unique fluorescence intensity manager (FIM) for fast, accurate, and reproducible adjustment of fluorescence lighting
- Motorized Excitation Manager and fast internal filter wheel (IFW) for multiple fluorescences
- Manual, absolute coded 7x objective turret for even provides fast adjustment of optimal settings
- Convenient Leica SmartTouch touchscreen for controlling the automated modules
- Optional, external Leica STP6000 SmartTouch Panel control for intuitive, convenient remote control of the microscope



Leica DM6000 B

The research microscope that leaves nothing to be desired

- Customized system for all types of life science research
- Automated transmitted light axis, including Leica's unique, fully automated DIC
- Motorized fluorescence axis with 5 or 8-position filter cube turret
- Leica's unique fluorescence intensity manager (FIM) for fast, accurate, and reproducible adjustment of the fluorescence lighting
- Motorized Excitation Manager and fast Internal Filter Wheel (IFW) for multiple fluorescences
- Motorized focus drive and motorized stage with reproducible x, y, and z positions
- Motorized 7-position objective turret with improved coding
- One-of-a-kind memory function for simultaneous change of objective and contrast method
- Convenient Leica SmartTouch touchscreen for controlling the automated modules
- Optional, external Leica STP6000 SmartTouch Panel control for intuitive, convenient remote control of the microscope



Specifications

		Leica DM4000 B LED	Leica DM5000 B	Leica DM5500 B
Stand	Power supply	– integrated within stand	– within electronics box CTR5000	– within electronics box CTR5500
	Display	– information display	– Leica SmartTouch with information and controls	– Leica SmartTouch with information and controls
	Interfaces	– 1 x USB 2.0, 1 x I ² C	– 2 x USB 2.0, 2 x I ² C	– 2 x USB 2.0, 2 x I ² C
Operation	Focus	– mechanical – 2-ratio gearbox (coarse/fine)	– mechanical – 2-ratio gearbox (coarse/fine)	– motorized – 5 electronic ratios – includes parfocal function – switch between coarse and fine mode – memory locations for two z-positions
	Objective turret	– absolute coded	– absolute coded	– absolute coded
		– 6x M25 thread – 7x M25 thread (optional)	– 7x M25 thread	– 7x M25 thread
	Stage			– motorized (optional) – with stepper motor – switch between fast and precision mode – includes memory location for up to 5 stage positions
		– mechanical – ceramic-coated – y-drive with belt – removable stage drive with adjustable torque – 110° swivel – left-handed version optionally available	– mechanical – ceramic-coated – y-drive with belt – removable stage drive with adjustable torque – 110° swivel – left-handed version optionally available	– mechanical – ceramic-coated – y-drive with belt – removable stage drive with adjustable torque – 110° swivel – left-handed version optionally available
	Controls	– 6 programmable function buttons	– 6 programmable function buttons	– 6 programmable function buttons
			– SmartMove – controls for z (focus) movement and x,y (stage) movement – 4 programmable function buttons – Leica STP6000 – controls for z (coarse and fine focus) and x,y (stage) movement – 11 programmable function buttons – touchpanel with information and control panels	
Transmitted light axis	Illumination	– Constant color LED	– 12 V 100 W halogen lamp	– 12 V 100 W halogen lamp
	Automation	– automated lighting manager* – automated contrast manager** – Constant Color Intensity Control	– automated lighting manager* – automated contrast manager** – Constant Color Intensity Control	– automated lighting manager* – automated contrast manager** – Constant Color Intensity Control
	Contrast method	– BF, PH, DF, POL	– BF, PH, DF, POL – DIC (fully automated)	– BF, PH, DF, POL – DIC (fully automatic)
Fluorescence axis	Motorized filter cube turret	– 5x	– 5x – 8x	– 5x – 8x
	Illumination	– Leica EL6000 – Leica SFL100/4000	– Leica EL6000 – Leica SFL4000/7000	– Leica EL6000 – Leica SFL4000/7000
	Automation	– Fluorescence Intensity Manager (FIM) – automated contrast manager – round and square illuminated field diaphragms for ocular and camera observation (motorized)	– Fluorescence Intensity Manager (FIM) – automated contrast manager – round and square illuminated field diaphragms for ocular and camera observation (motorized) – optional: internal filter wheel and motorized Excitation Manager	– Fluorescence Intensity Manager (FIM) – automated contrast manager – round and square illuminated field diaphragms for ocular and camera observation (motorized) – optional: internal filter wheel and motorized Excitation Manager
Condensers	Automation	– condenser head, motorized – 7x condenser disk, motorized (optional) – polarizer, motorized (optional)	– condenser head, motorized – 7x condenser disk, motorized (optional) – polarizer, motorized (optional)	– condenser head, mot. – 7x condenser disk, mot. (optional) – polarizer, motorized (optional)

* adjustment of brightness, aperture and field stop

** automatic contrast process

Leica DM6000 B

– within electronics box CTR6000

– Leica SmartTouch
with information and controls

– 2 x USB 2.0, 2 x I²C

– motorized
– 5 electronic ratios
– includes parfocal function
– switch between coarse
and fine mode
– memory locations for two z-positions

– motorized
– includes dry and immersion mode

– 7x M25 thread

– motorized (optional)
– with stepper motor
– switch between fast and precision mode
– includes memory location for up to
5 stage positions

– mechanical
– ceramic-coated
– y-drive with belt
– removable stage drive
with adjustable torque
– 110° swivel
– left-handed version optionally available

– 6 programmable function buttons

– SmartMove
– controls for z (focus) movement
and x,y (stage) movement
– 4 programmable function buttons
– Leica STP6000
– controls for z (coarse and fine focus)
and x,y (stage) movement
– 11 programmable function buttons
– touchpanel with information
and control panels

– 12 V 100 W halogen lamp

– automated lighting manager*
– automated contrast manager**
– Constant Color Intensity Control

– BF, PH, DF, POL
– DIC (fully automated)

– 5x
– 8x

– Leica EL6000
– Leica SFL4000/7000

– Fluorescence Intensity Manager (FIM)
– automated contrast manager
– round and square illuminated field diaphragms
for ocular and camera observation (motorized)
– optional: internal filter wheel and motorized
Excitation Manager

– condenser head, motorized
– 7x condenser disk, motorized (optional)
– polarizer, motorized (optional)

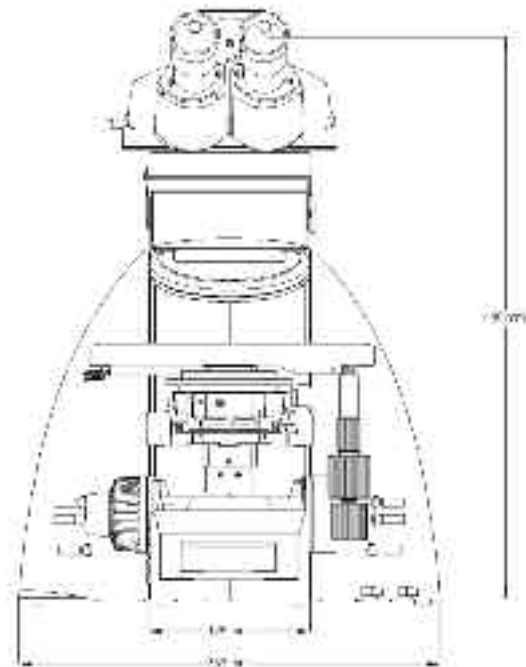
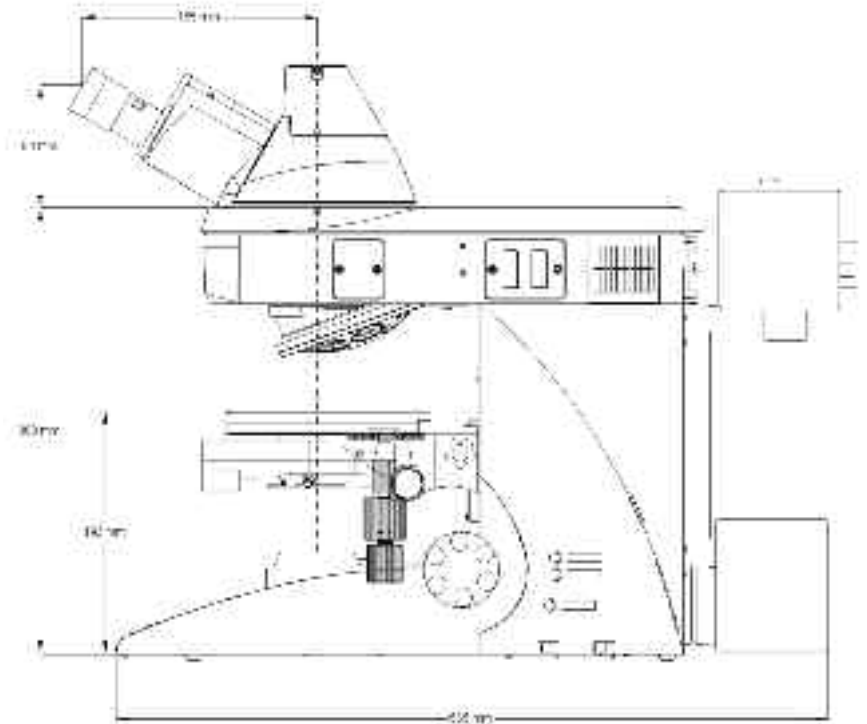

System overview

Leica DM4000 B LED/DM5000 B DM5500 B/DM6000 B

Tube program L

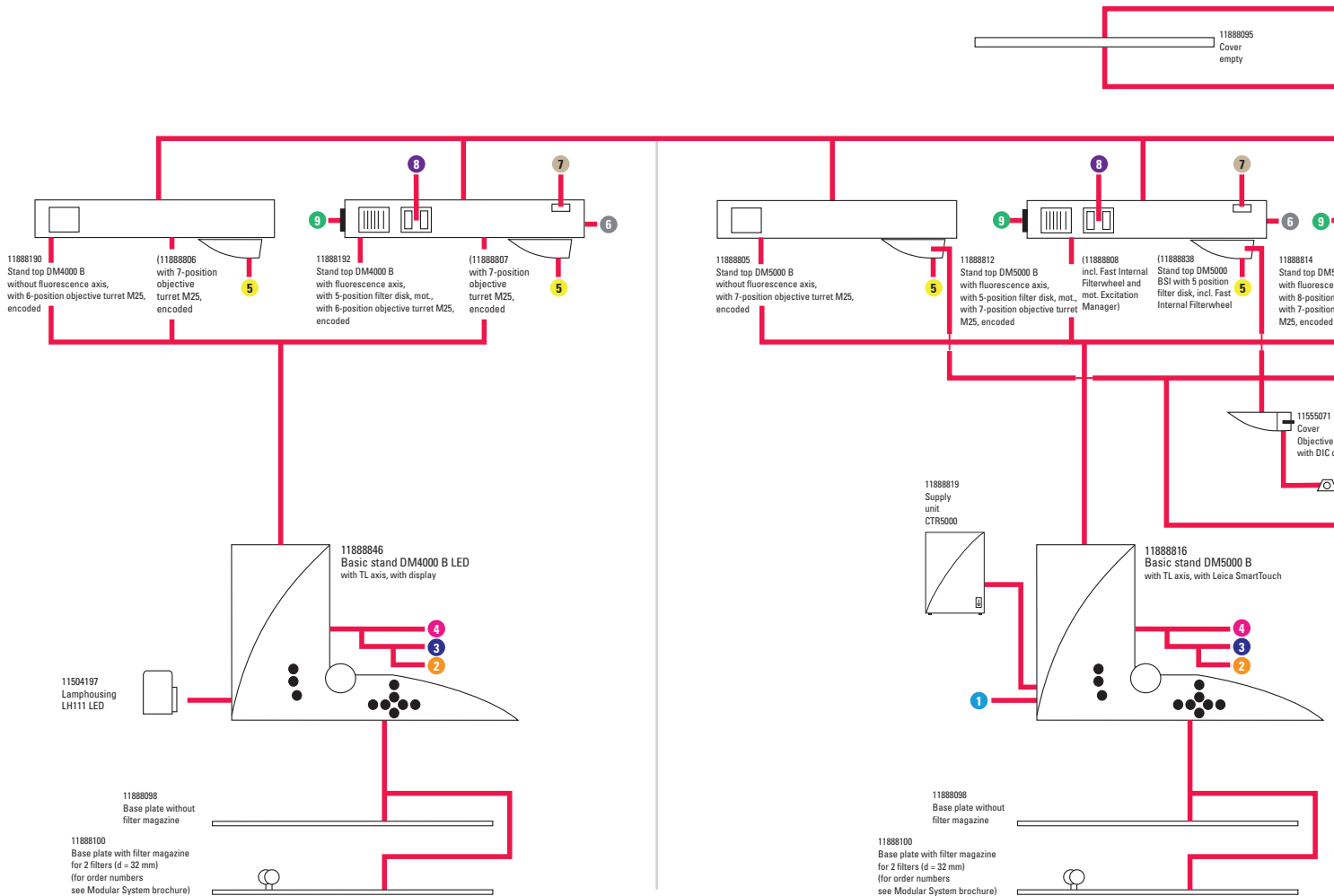
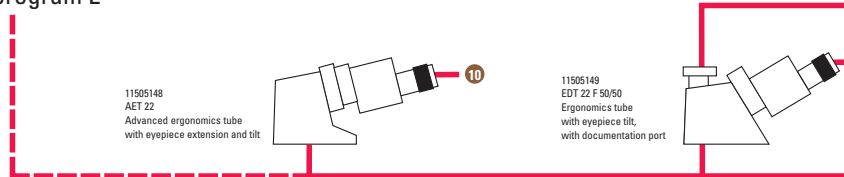

Leica DM4000 B LED

Leica DM5000 B

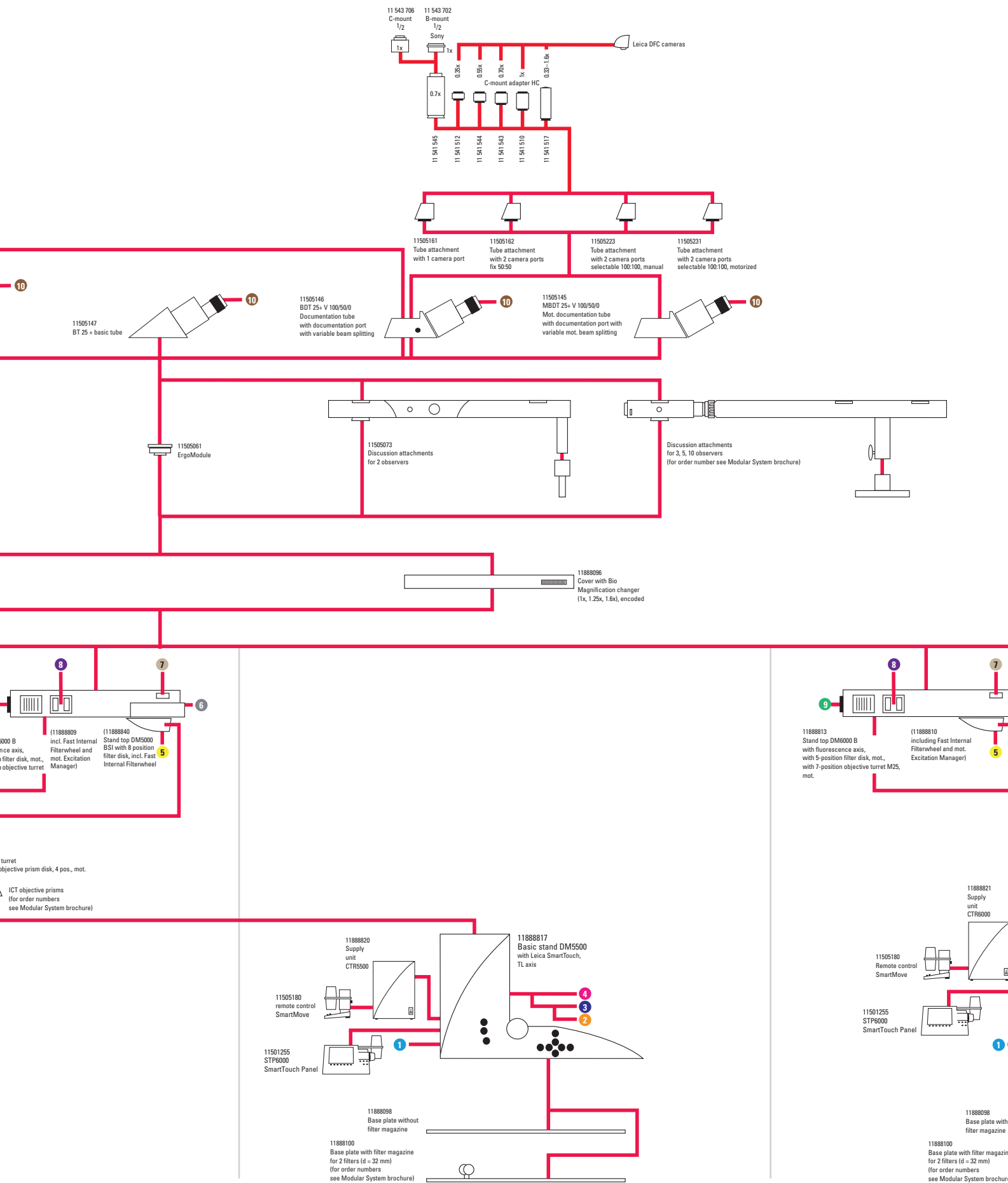

Leica DM5500 B

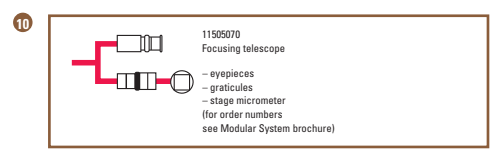
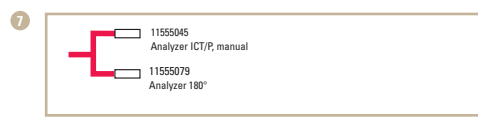
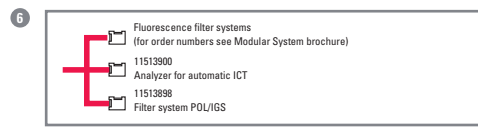
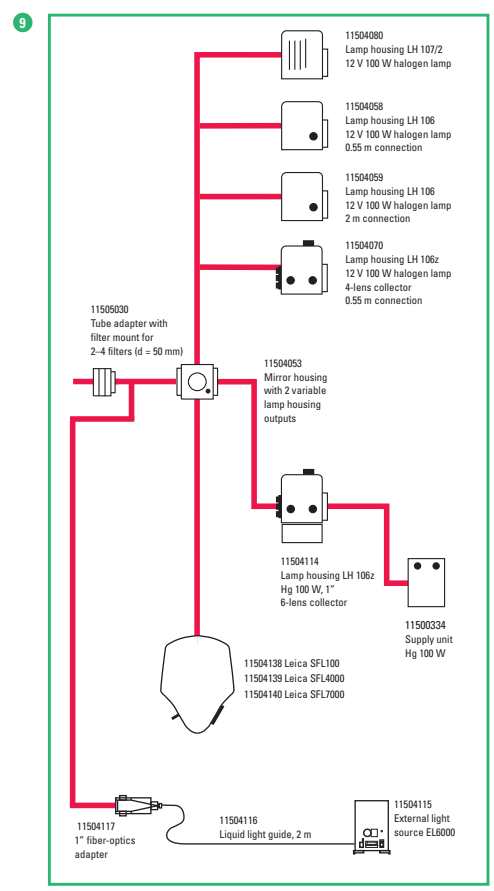
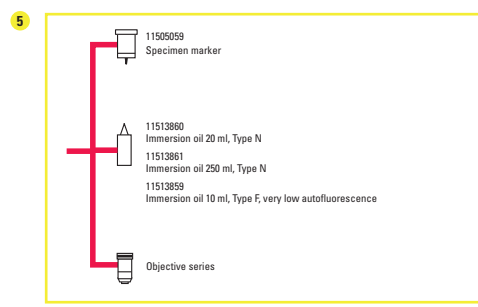
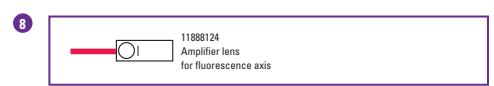
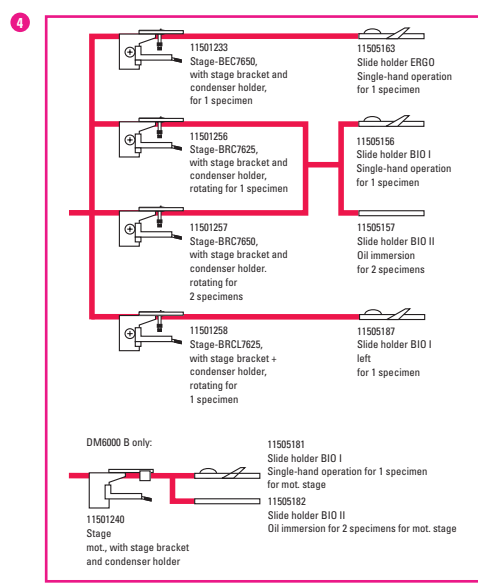
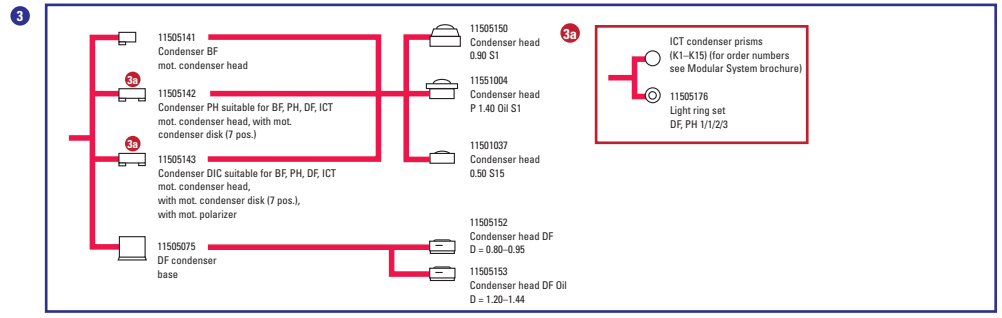
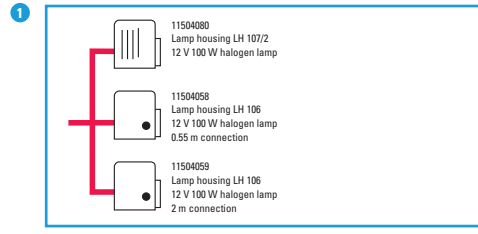
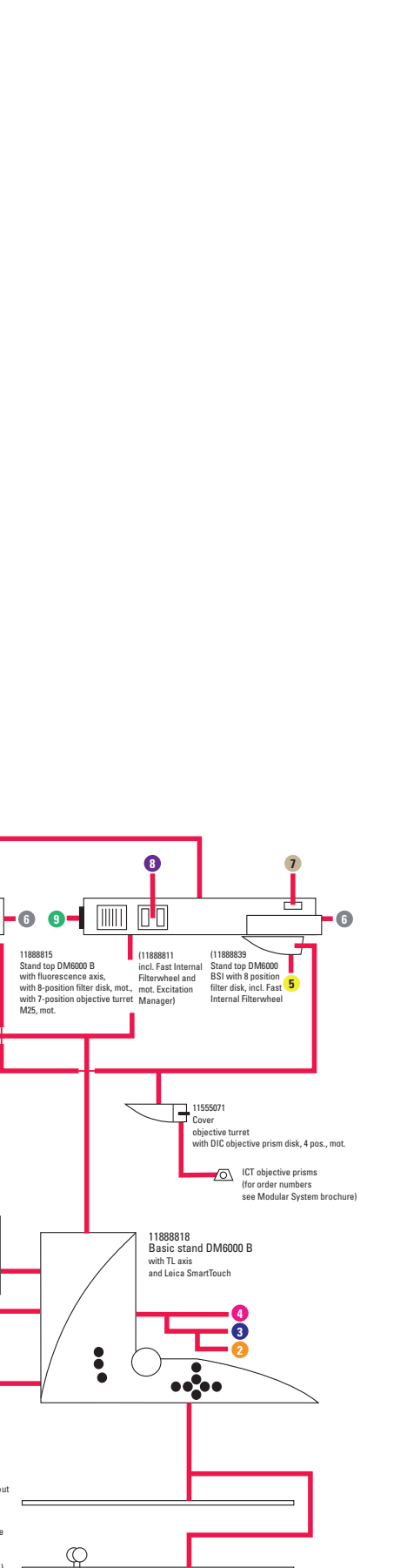



ICA DM6000

Leica

Status/Info-Buttons Do info

Contrast-Method : TL-BF
Objective : 10x

Intensity [Coarse] Shutter Axis
- 20 + TL-Shutter TL

Aperture Field IL
- 10 + - 32 + IL

The statement by Ernst Leitz in 1907, *"With the User, For the User,"* describes the fruitful collaboration with end users and driving force of innovation at Leica Microsystems. We have developed five brand values to live up to this tradition: Pioneering, High-end Quality, Team Spirit, Dedication to Science, and Continuous Improvement. For us, living up to these values means: **Living up to Life**.

Leica Microsystems operates globally in four divisions, where we rank with the market leaders.

Leica Microsystems – an international company with a strong network of worldwide customer services:

LIFE SCIENCE DIVISION

The Leica Microsystems Life Science Division supports the imaging needs of the scientific community with advanced innovation and technical expertise for the visualization, measurement, and analysis of microstructures. Our strong focus on understanding scientific applications puts Leica Microsystems' customers at the leading edge of science.

INDUSTRY DIVISION

The Leica Microsystems Industry Division's focus is to support customers' pursuit of the highest quality end result. Leica Microsystems provide the best and most innovative imaging systems to see, measure, and analyze the microstructures in routine and research industrial applications, materials science, quality control, forensic science investigation, and educational applications.

BIOSYSTEMS DIVISION

The Leica Microsystems Biosystems Division brings histopathology labs and researchers the highest-quality, most comprehensive product range. From patient to pathologist, the range includes the ideal product for each histology step and high-productivity workflow solutions for the entire lab. With complete histology systems featuring innovative automation and Novocastra™ reagents, Leica Microsystems creates better patient care through rapid turnaround, diagnostic confidence, and close customer collaboration.

MEDICAL DIVISION

The Leica Microsystems Medical Division's focus is to partner with and support surgeons and their care of patients with the highest-quality, most innovative surgical microscope technology today and into the future.

Active worldwide	Tel.	Fax
Australia · North Ryde	+61 2 8870 3500	2 9878 1055
Austria · Vienna	+43 1 486 80 50 0	1 486 80 50 30
Belgium · Diegem	+32 2 790 98 50	2 790 98 68
Canada · Concord/Ontario	+1 800 248 0123	847 405 0164
Denmark · Ballerup	+45 4454 0101	4454 0111
France · Nanterre Cedex	+33 811 000 664	1 56 05 23 23
Germany · Wetzlar	+49 64 41 29 40 00	64 41 29 41 55
Italy · Milan	+39 02 574 861	02 574 03392
Japan · Tokyo	+81 3 5421 2800	3 5421 2896
Korea · Seoul	+82 2 514 65 43	2 514 65 48
Netherlands · Rijswijk	+31 70 4132 100	70 4132 109
People's Rep. of China · Hong Kong · Shanghai	+852 2564 6699 +86 21 6387 6606	2564 4163 21 6387 6698
Portugal · Lisbon	+351 21 388 9112	21 385 4668
Singapore	+65 6779 7823	6773 0628
Spain · Barcelona	+34 93 494 95 30	93 494 95 32
Sweden · Kista	+46 8 625 45 45	8 625 45 10
Switzerland · Heerbrugg	+41 71 726 34 34	71 726 34 44
United Kingdom · Milton Keynes	+44 800 298 2344	1908 246312
USA · Buffalo Grove/Illinois	+1 800 248 0123	847 405 0164