



+ Custom design

The MADEIRA is fully personalisable and can be configured by integrating: door, drawer, and technical equipment (x-ray film viewer, multimedia screen, haemodialysis water purifier, wardrobe, bedside table, etc.).

+ Design and ergonomics

There is a wide choice of materials and colours, to adapt the panels to your needs. The smooth surfaces of the MADEIRA make it easy to clean and disinfect.



TECHNICAL FEATURES

Front view

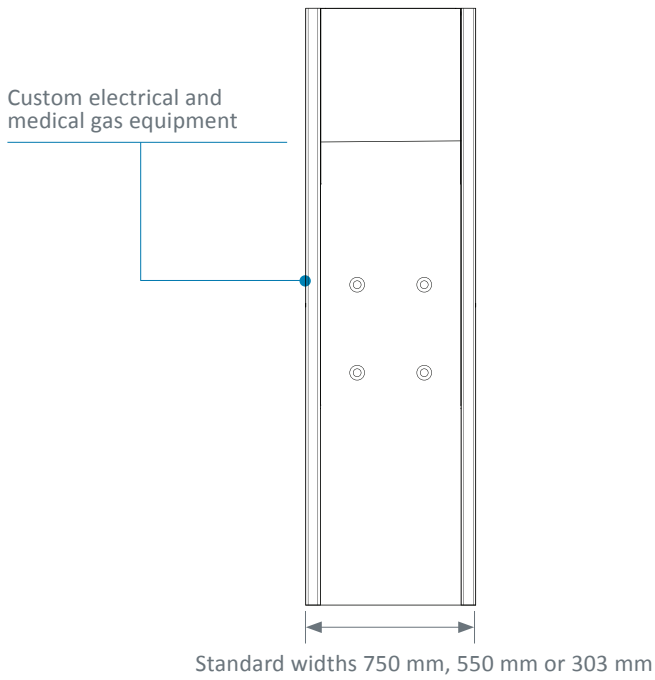

Side view

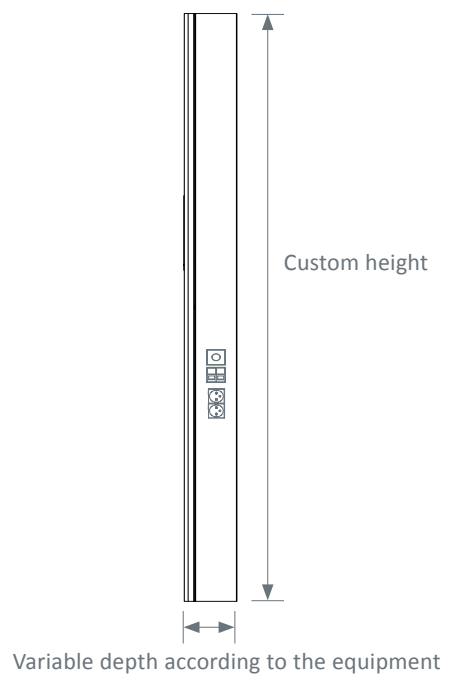

Colours

The MADEIRA architectural concept offers a wide range of materials and colours for the panels (wood or metal), personalisable according to your choice.

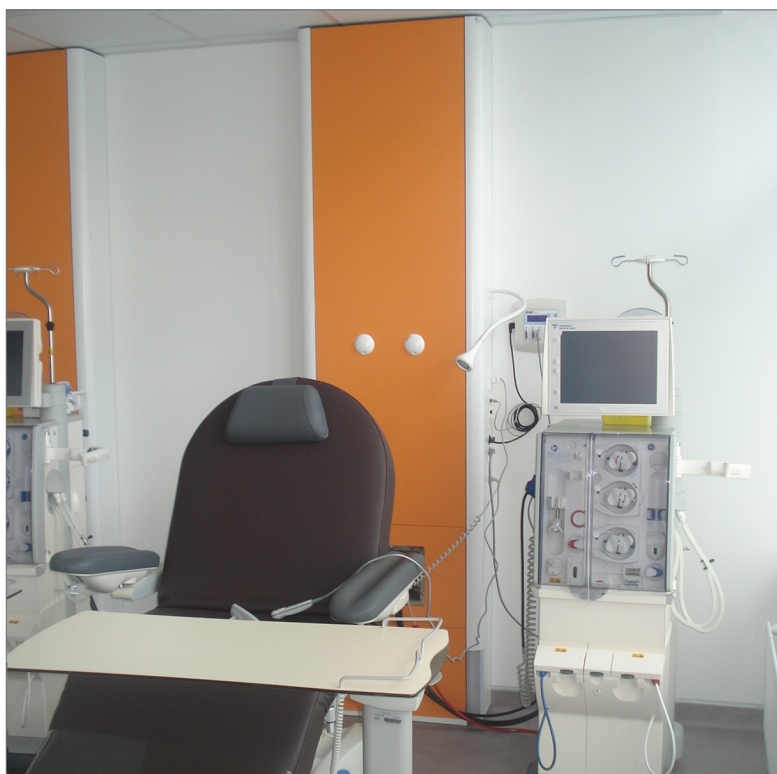

FUNCTIONALITY

This concept produces a complete medical device that includes all the essential functionality for patients and care teams.

Power supply

For all your construction or renovation projects, supplies from the ceiling, floor, hallway, or lavatory will give you reliable access to energies for all types of caring. This includes haemodialysis units. It can also be fed from behind.

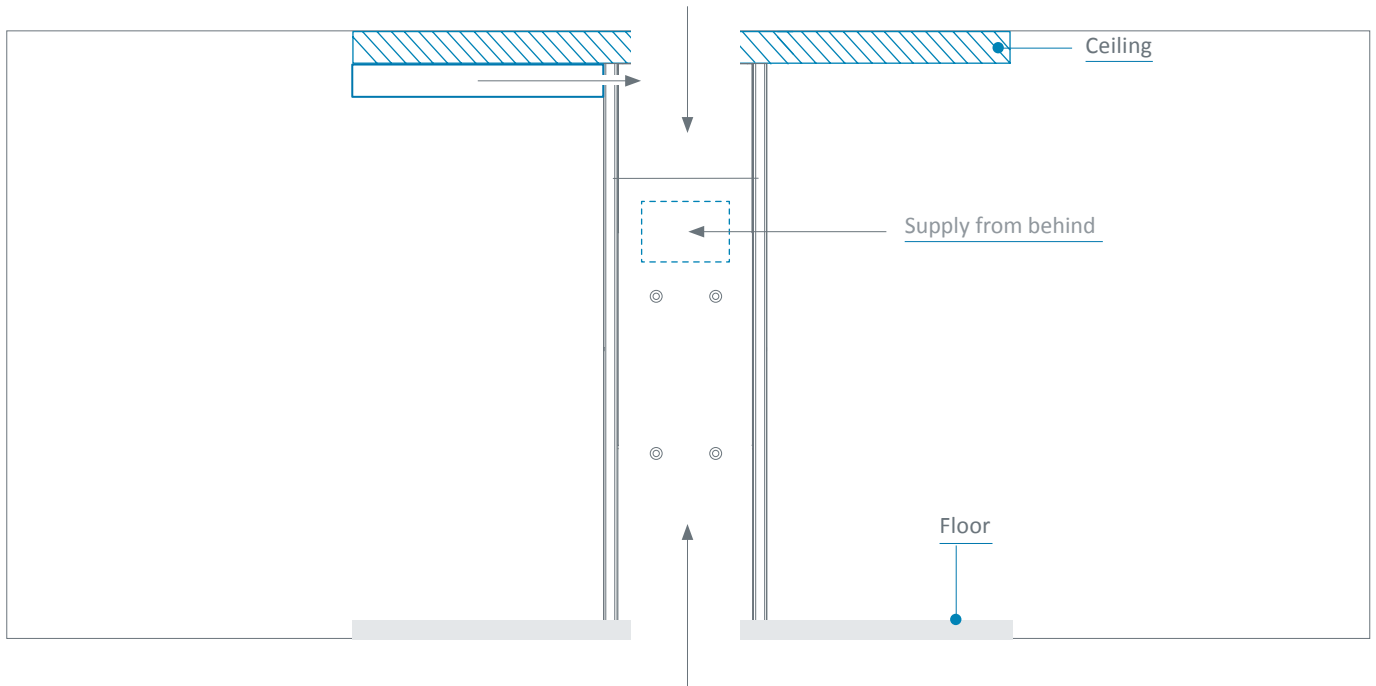

Electrical equipment integration

The waterjet cutting of the MADEIRA's cover enables exact and customized cutting. It can integrate all forms of outlets. Electrical devices are flush-mounted, for easy cleaning and disinfection of the product.



Medical gas casing

ABS / PC medical gas casings are available with flap for AFNOR gas outlets, and without flap for any other outlet standards.



EQUIPMENT & LIGHTING

Equipment

The MADEIRA concept can incorporate extra low/low voltage devices and medical gas on the front panel or the side. If necessary, the side profiles can be equipped with an accessory mounting rail (on the right and/or left-hand side), where biomedical accessories can be attached.

It can include your choice of technical devices, such as:

Haemodialysis water purifier



Multimedia screen



Lighting

Combined with a wall-mounted lighting unit from the TLV range (SERENISSIMA, PANAMA or GOODLIGHT), it provides a comfortable and efficient lighting solution to contribute to the well-being of patients and healthcare professionals.

MADEIRA can optionally be equipped with the following:

A FLEX-E LED reading spotlight on flexible stem



LED night light built into the bottom fitting.



A night light using one 6-W compact fluorescent tube, laterally in the lower part of the bed head unit, to the right and/or left.



LUMIA LED wall lighting unit



CONFIGURATIONS

Example MADEIRA configurations

With a bedside table and cupboard in the lower part.

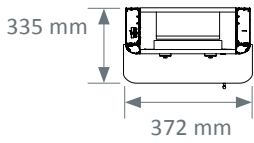
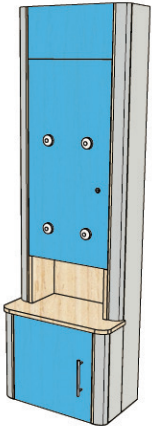

With a cupboard at the top and a wardrobe equipped with safe.

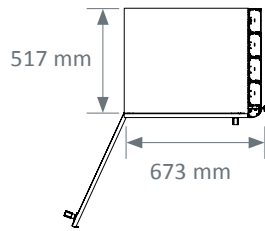
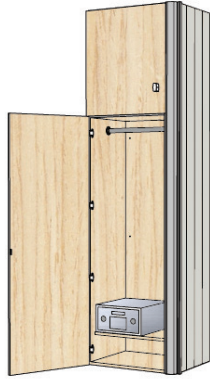

With a haemodialysis water purifier.

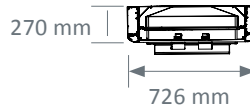

With a top and bottom cupboard.

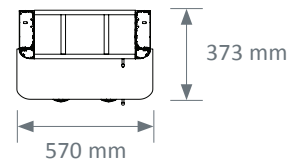
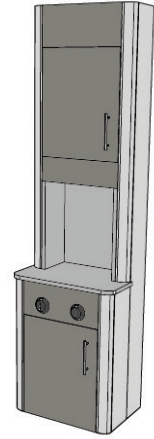

With upper niches and a bedside table in the lower part, where a refrigerator can be integrated.

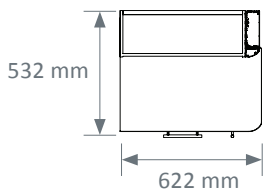

With wood panels covering the electrical distribution profiles.

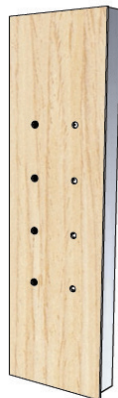

With steel front panel.



With wood panels between the electrical distribution profiles.



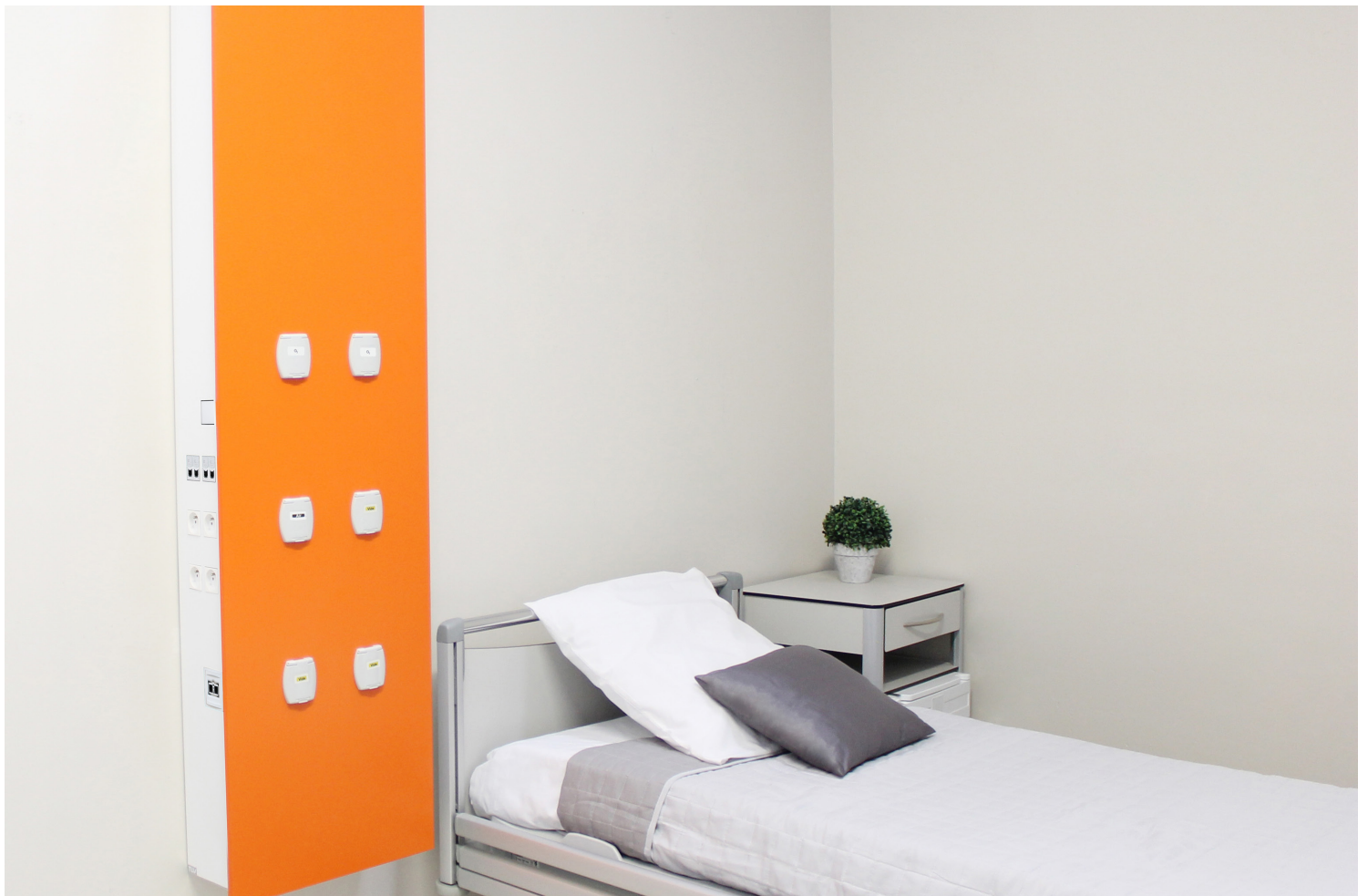





Norms & recommendations

- EN ISO 9001 and EN ISO 13485: Quality management systems
- CE Medical Devices Marking according to 93/42/EEC Directive
- EN ISO 11197: Medical supply units
- EN ISO 7396-1: Medical gas pipeline systems - Part 1
- European rules for caring centers lighting

Ceiling pendants, Suspended Beams & Columns, Bed head units / trunkings,
Sealed ceiling lightings, Medical gases monitoring & Biomedical Accessories



All specifications herein are provided for information purposes only and may be modified by TLV without notice.(B) - Update (JJ/MM/AA) - 12/04/2016