

Akcesoria



K2-663
Plomba zamknięcia z indykatorem,
plastikowa 100szt. (NIEBIESKA)



K2-662
Plomba zamknięcia z indykatorem,
plastikowa 100szt. (CZERWONA)



K2-664
Plomba zamknięcia,
plastikowa 100szt. (NIEBIESKA)



K2-660
Plomba zamknięcia,
plastikowa 100szt. (CZERWONA)



K2-661
Plomba zamknięcia z numerem,
plastikowa 100szt. (NIEBIESKA)



K2-665
Plomba zamknięcia z numerem,
plastikowa 100szt. (CZERWONA)

Jednorazowe plomby zamknięcia zostają zerwane podczas otwarcia zamka kontenera; ich zastosowanie pozwala na kontrolę sterylności pakietu.



K2-672
Etykiety papierowe 100szt.
z indykatorem
Do kontenerów dużych

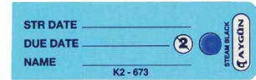

K2-673
Etykiety papierowe 100szt.
z indykatorem
Do kontenerów małych
i przeznaczenia specjalnego



- **K2-700**
- **K2-701**
- **K2-702**
- **K2-703**
- **K2-704**
- **K2-705**

Kolorowe tabliczki identyfikacyjne grawerowane według wytycznych max. 16 znaków

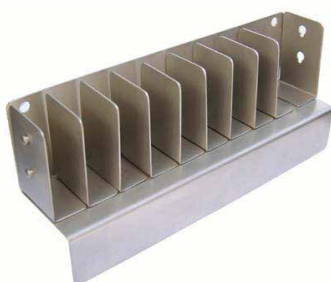

K2-690
Podajnik na etabliczki identyfikacyjne



K2-680
Podajnik na tabliczki identyfikacyjne

Maty silikonowe

Rozwiązania dla **sterylizacji i dezynfekcji**

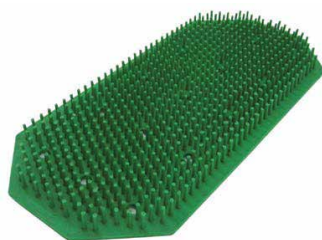
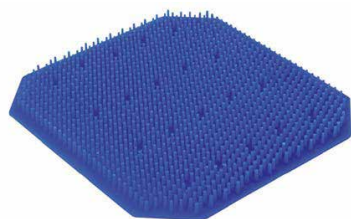

K2-520	275 x 125 mm
K2-529	260 x 180 mm
K2-521	250 x 235 mm
K2-527	230 x 220 mm
K2-523	300 x 300 mm
K2-524	380 x 230 mm
K2-525	440 x 230 mm
K2-528	470 x 230 mm
K2-526	520 x 230 mm

Maty silikonowe



K2-530	250 x 240 x 2,0 mm
K2-531	480 x 250 x 2,0 mm

Maty silikonowe

Umożliwiają stabilne przechowywanie narzędzi chirurgicznych i zapewniają lepsze suszenie

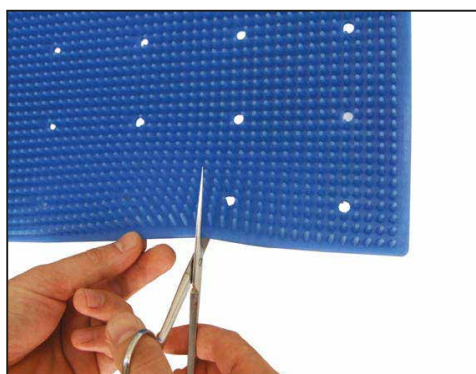

Silikonowe uchwyty mocujące

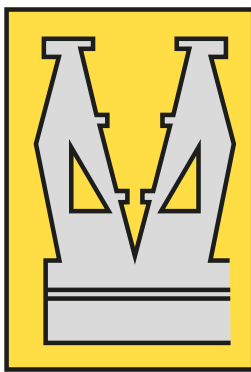
K12-100 L= 250 mm H= 41 mm
K12-101 L= 152 mm H= 41 mm
K12-102 L= 125 mm H= 41 mm
K12-145 L= 97 mm H= 41 mm

K12-103 L= 240 mm H= 41 mm
K12-104 L= 150 mm H= 41 mm
K12-105 L= 120 mm H= 41 mm
K12-146 L= 90 mm H= 41 mm

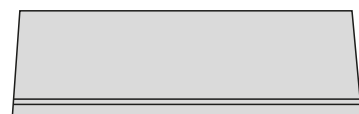
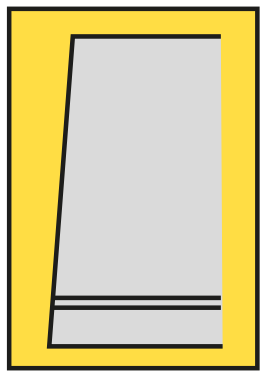
K12-106 L= 238 mm H= 41 mm
K12-107 L= 150 mm H= 41 mm
K12-108 L= 119 mm H= 41 mm
K12-147 L= 87 mm H= 41 mm

K12-109 L= 238 mm H= 41 mm
K12-110 L= 158 mm H= 41 mm
K12-111 L= 112 mm H= 41 mm
K12-148 L= 77 mm H= 41 mm

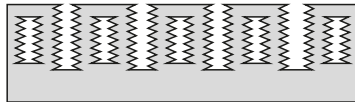
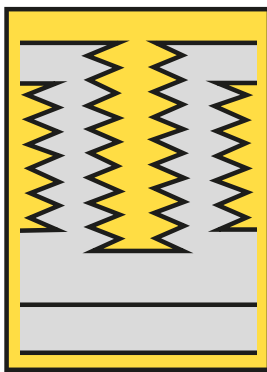
K12-112 L= 178 mm H= 20 mm
 Uchwyt na narzędzia od Ø 3 do 8 mm

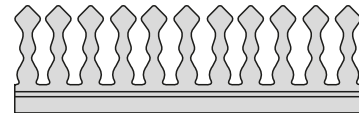
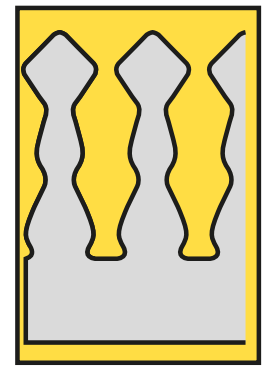
K12-113 L= 73 mm H= 20 mm
 Uchwyt na narzędzia Ø 5 mm

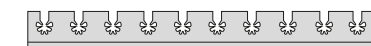
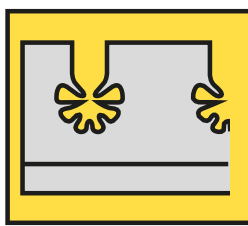
K12-114 L= 73 mm H= 20 mm
 Uchwyt na narzędzia Ø 3 mm

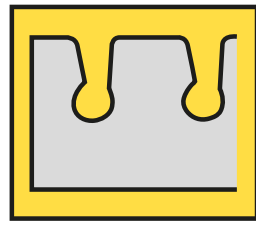
K12-115 L= 178 mm H= 30 mm
 Uchwyt na narzędzia od Ø 3 do 8 mm

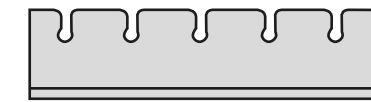
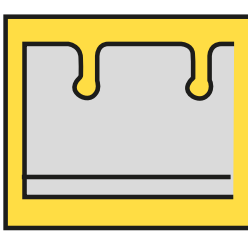

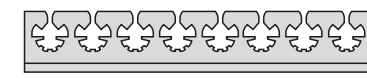
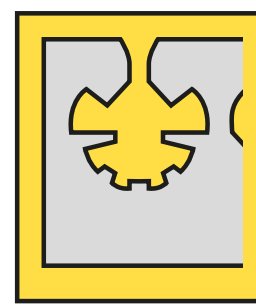

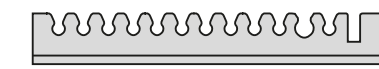
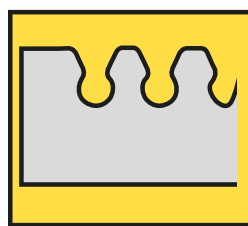
K12-116 L= 121 mm H= 18 mm

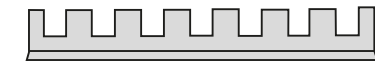
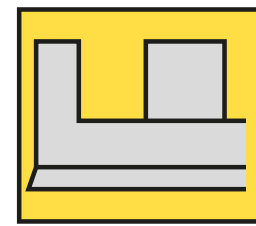

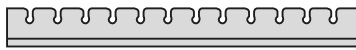

K12-117 L= 123 mm H= 18 mm

L- długość H- wysokość

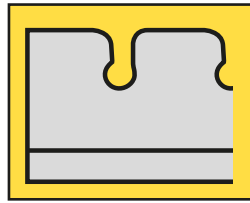

K12-124 L= 178 mm H= 20 mm



K12-125 L= 178 mm H= 20 mm

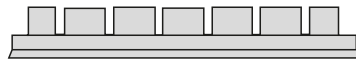
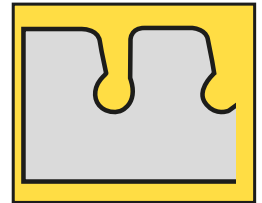

K12-123 L= 123 mm H= 18 mm

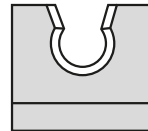
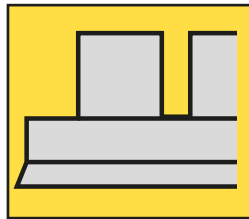

K12-127 L= 23.5 mm H= 21 mm
Ø 8 mm

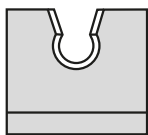
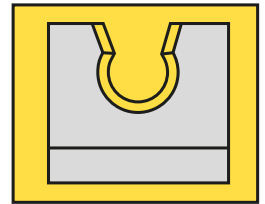

K12-129 L= 23.5 mm H= 21 mm
Ø 5 mm

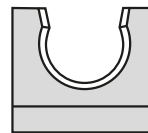
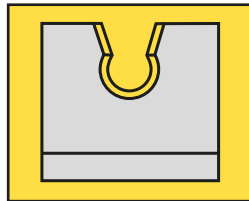

K12-128 L= 23.5 mm H= 21 mm
Ø 13 mm

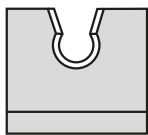
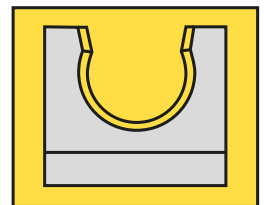

K12-126 L= 23.5 mm H= 21 mm
Ø 10.5 mm

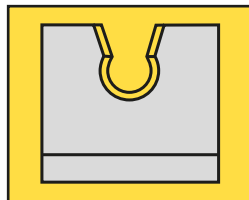

Silikonowe uchwyty mocujące

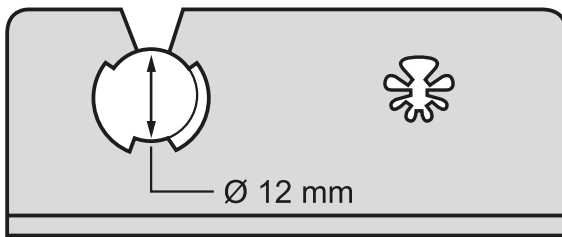

K12-141 L= 72 mm H= 30 mm
Uchwyt do endoskopu, podwójny
jeden \varnothing 15 mm - otwarty
drugi od \varnothing 3 do \varnothing 15 mm

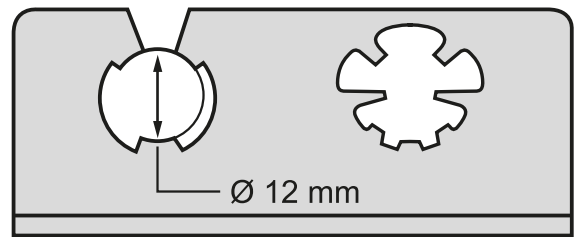

K12-130 L= 72 mm H= 30 mm
Uchwyt do endoskopu, podwójny
jeden \varnothing 15 mm - otwarty
drugi od \varnothing 3 do \varnothing 15 mm

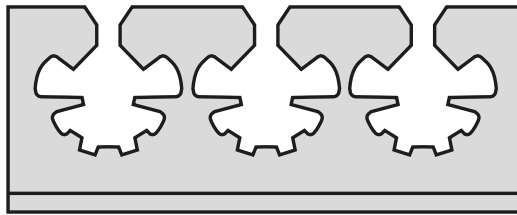

K12-131 L= 72 mm H= 30 mm
Uchwyt do narzędzi
od \varnothing 3 do \varnothing 15 mm

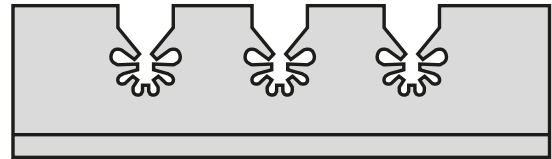

K12-132 L= 72 mm H= 30 mm
Uchwyt do narzędzi
od \varnothing 3 do \varnothing 8 mm

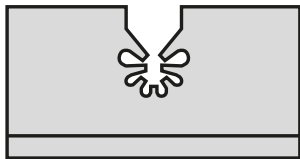

K12-133 L= 38 mm H= 20 mm
Uchwyt do endoskopu
od \varnothing 3 do \varnothing 8 mm - otwarty

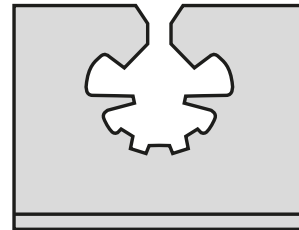

K12-134 L= 38 mm H= 30 mm
Uchwyt do endoskopu
 \varnothing 12 mm - otwarty

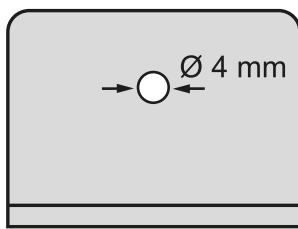

K12-135 L= 38 mm H= 29 mm
Uchwyt na endoskop \varnothing 4 mm - zamknięty

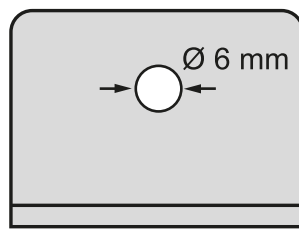

K12-136 L= 38 mm H= 29 mm
Uchwyt na endoskop \varnothing 6 mm - zamknięty

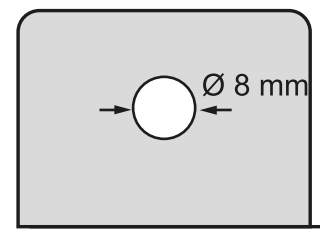

K12-137 L= 38 mm H= 29 mm
Uchwyt na endoskop \varnothing 8 mm - zamknięty

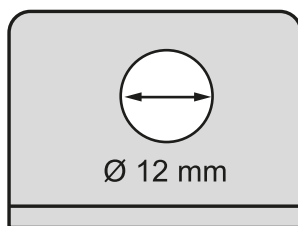

K12-138 L= 38 mm H= 29 mm
Uchwyt na endoskop \varnothing 12 mm - zamknięty

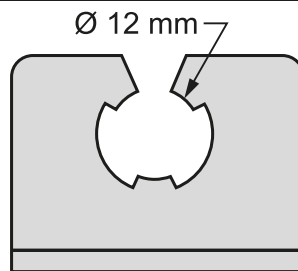

K12-139 L= 38 mm H= 29 mm
Uchwyt na endoskop \varnothing 12 mm - otwarty

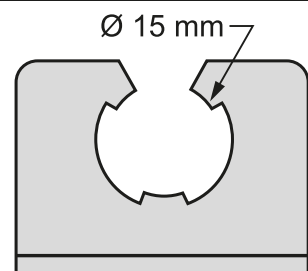

K12-140 L= 38 mm H= 29 mm
Uchwyt na endoskop \varnothing 15 mm - otwarty

L- długość H- wysokość

Filtry



K2-740

Filtr papierowy jednorazowy 100szt.
z indykatozem i znakiem AYGUN



K2-741

Filtr papierowy jednorazowy 100szt.
z indykatozem; bez oznakowania



K2-742

Filtr teflonowy
żywność > 1200 cykli



K3-612

Filtr papierowy jednorazowy 100szt.
z indykatozem i znakiem AYGUN



K3-615

Filtr papierowy jednorazowy 100szt.
z indykatozem; bez oznakowania



K2-743

Filtr teflonowy
żywność > 1200 cykli



K2-760

Filtr papierowy jednorazowy 100szt.
z indykatozem i znakiem AYGUN



K2-761

Filtr papierowy jednorazowy 100szt.
z indykatozem; bez oznakowania



K2-744

Filtr teflonowy
żywność > 1200 cykli



Uchwyty do filtrów



K2-720

Uchwyt filtra, do rozmiarów: 1/1, 3/4, 1/2, XL
do jednorazowych filtrów papierowych

K2-721

do filtrów teflonowych



K2-730

Podajnik filtrów

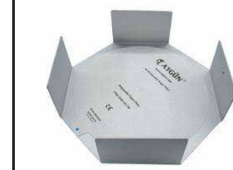

K2-1715

Uchwyt filtra, do modelu DENTAL



K2-1708

Podajnik filtrów



K2-1716

Uchwyt filtra, do modelu MINI



K2-1709

Podajnik filtrów



USZCZELKI SILIKONOWE DO POKRYW



	Model	Rozmiar
K3-950	Mini	300 x 140 mm
K3-951	Dental	310 x 190 mm
K3-952	Flat	285 x 280 mm
K3-953	1/2	285 x 280 mm
K3-954	3/4	465 x 280 mm
K3-955	1/1	580 x 280 mm
K3-956	XL	590 x 370 mm



K3-1000

Klej silikonowy

Do montażu używać kleju silikonowego K3-1000

Oslony rączek

- K2-710** CZERWONY
- K2-711** ŻÓŁTY
- K2-712** ZIELONY
- K2-713** NIEBIESKI
- K2-714** SZARY
- K2-715** CZARNY

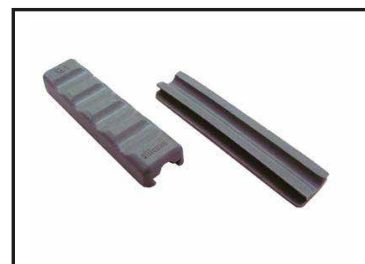
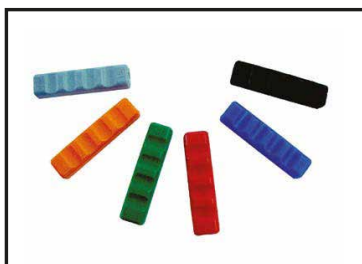

Silikonowe osłony rączek dostępne są w sześciu kolorach; możliwe do zdemontowania przez użytkownika.

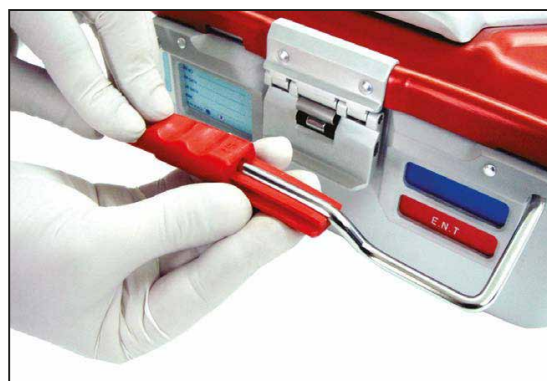

Akcesoria

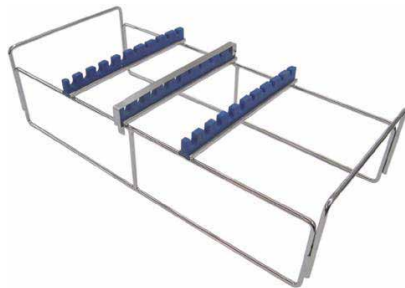

K3-1090

Stojak do endoskopów
Mieści 10 narzędzi endoskopowych
Pasuje do kontenerów 1/1 o głębokości 20 cm

Kosz siatkowy 1/1 50 mm
Kontener 1/1 200 mm
Mata silikonowa 520 x 230 mm

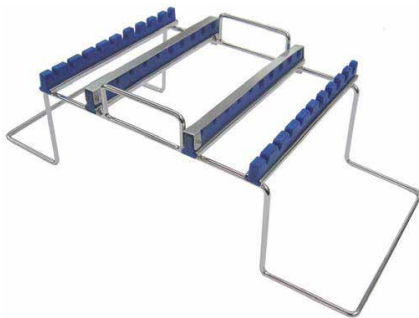
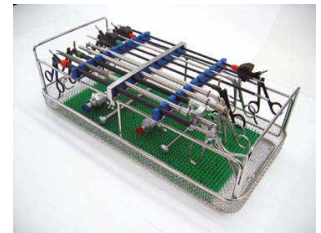

K3-1092

Stojak do artroskopów
Mieści 20 narzędzi artroskopowych
Pasuje do kontenerów 1/1 o głębokości 20 cm

Kosz siatkowy 1/1 50 mm
Kontener 1/1 200 mm
Mata silikonowa 440 x 230 mm

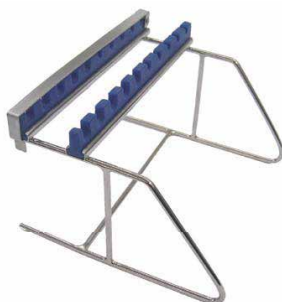
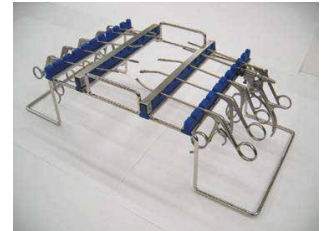

K3-1094

Stojak do narzędzi - kerrison
Mieści 10 narzędzi
Pasuje do kontenerów o głębokości 20 cm

Kosz siatkowy 1/2 50 mm
Kosz siatkowy 1/1 50 mm
Kontener 1/2 200 mm
Kontener 1/1 200 mm

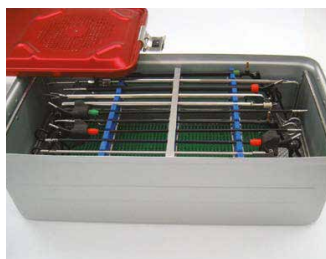
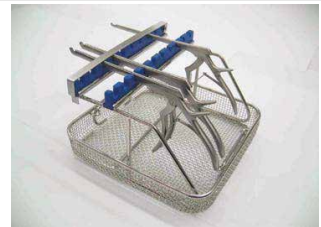
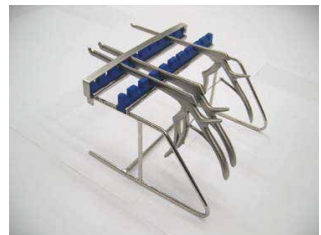

Akcesoria



K2-716
Uchwyt do tabliczek identyfikacyjnych
50 x 35 x 13 mm



K2-717
Znacznik
40 x 35 x 9 mm
Ilość znaków określona
przy składaniu zamówienia



K2-691
Stojak do przechowywania znaczników
i uchwytów do tabliczek
390 x 85 x 153 mm



- K2-560** CZERWONY
- K2-561** NIEBIESKI
- K2-562** ZIELONY
- K2-563** ŻÓŁTY
- K2-564** SZARY
- K2-565** CZARNY



- K2-570**
- K2-571**
- K2-572**
- K2-573**
- K2-574**
- K2-575**

Kolorowe tabliczki identyfikacyjne
grawerowane według wytycznych

Kolor szary zalecany do sterylizacji plazmowej.
Pozostałe kolory mogą blaknąć w wyniku działania nadtlenu wodoru.



K2-569
Tabliczka informacyjna
ze spinaczem





K2-588
Klamra mocująca



K2-651
Trzpień mocujący do narzędzi



K2-650
Trzpień mocujący do podziałki

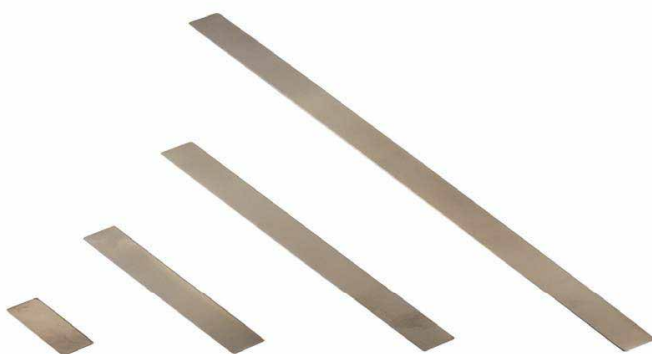

K2-645
PODZIAŁKA
50 X 20 mm

K2-646
PODZIAŁKA
130 X 20 mm

K2-647
PODZIAŁKA
225 X 20 mm

K2-648
PODZIAŁKA
460 X 20 mm



K2-580
KLAMRA MOCUJĄCA
Ø 7 - 12 mm



K2-581
KLAMRA MOCUJĄCA
Ø 12 - 16 mm



K2-582
KLAMRA MOCUJĄCA
Ø 16 - 26 mm



K2-583
KLAMRA MOCUJĄCA
Ø 26 - 36 mm



K2-584
KLAMRA MOCUJĄCA
Ø 36 - 45 mm

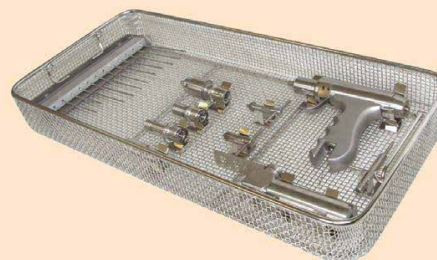
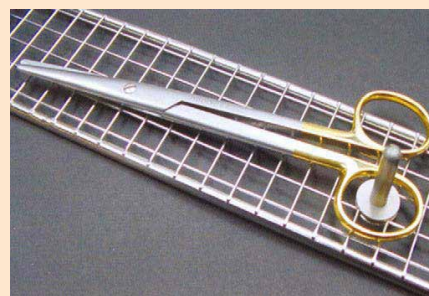
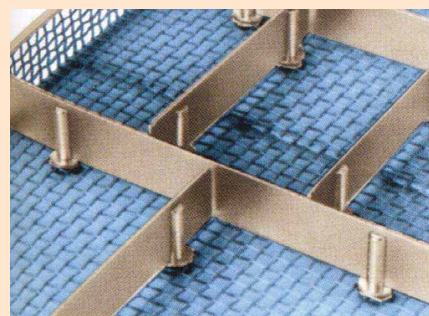

Akcesoria



M8-508
Stojak na 24 instrumenty Ø 2.35 mm



M8-509
Stojak na 15 instrumentów



M8-511
Stojak na 12 instrumentów



M8-490
Uchwyt do 6 mikro głowic



M8-510
Olej w sprayu



Akcesoria



K2-600 40 X 5 X 15 mm
PODZIAŁKA (pasuje do **K2-601** i **K2-602**)



K2-601 23 cm
K2-602 47 cm
Prowadnica, przykręcana



K2-604 23 cm
K2-605 47 cm
Ogranicznik, przykręcany



K2-607
Uchwyt spiralny



K2-609
Uchwyt spiralny



Akcesoria

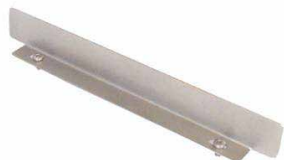

K2-615	11 mm
K2-616	17 mm
K2-617	23 mm
K2-618	47 mm

Ogranicznik



K2-620
Uchwyt spiralny



K2-622
Uchwyt spiralny



K2-625
Uchwyt spiralny



Rozwiązania dla **sterylizacji i dezynfekcji**



INFORMER MED sp. z o.o.

ul. Winogrody 118, 61-626 Poznań, POLAND

tel.: +48 61 66 43 810, fax: +48 61 66 43 819

e-mail: biuro@informermed.eu

www.informermed.eu