

BM



Nadelhalter, Naht-Instrumente,  
Unterbindungsnadeln und Hohlsonden  
Needle Holders, Suture Instruments,  
Ligature Needles, Guiding Probes

## Nadelhalter – Needle Holders

Mikro-Nadelhalter mit Flachgriff

Micro Needle Holders with Flat Handles

BM

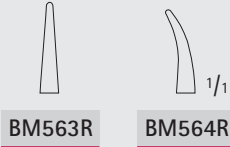

BM563R

BM564R

1/2

CASTROVIEJO

BM563R-BM564R

mit Sperre  
with catch

145 mm, 5 3/4"



FD076R

FD079R

1/2

FD076R-FD079R

ohne Sperre  
without catch

160 mm, 6 1/4"

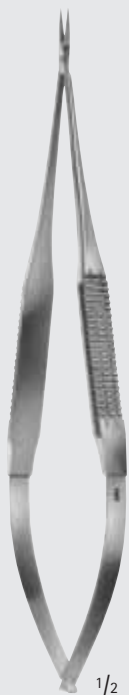

FD080R

FD081R

1/2

FD080R-FD081R

ohne Sperre  
without catch

185 mm, 7 1/4"



FD045R

ohne Sperre  
without catch

FD046R

mit Sperre  
with catch

1/2

JACOBSON

FD045R-FD046R

185 mm, 7 1/4"

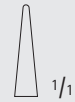

1/2

FD048R

mit Sperre  
with catch

200 mm, 8"



## Nadelhalter – Needle Holders

### Mikro-Nadelhalter mit Rundgriffen

### Micro Needle Holders with Round Handles

BM

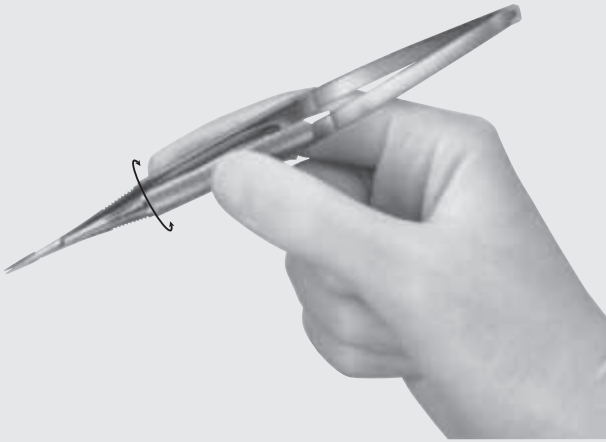

#### ... mit Rundgriffen

- Rundgriffe erlauben Drehbewegungen zwischen den Fingern.
- Optimale Balance, individuell je nach Instrument, durch volle oder gehöhlte Griffpartien.

#### ... with round handles

- Round handles allow turning manipulations between the fingers.
- Optimum balance individually for each instrument due to solid or hollowed-out handles.

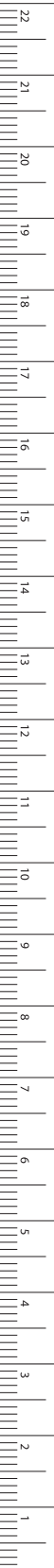

MM/MILLIMETERS



BARRAQUER

**BM560R-BM562R**

ohne Sperre  
without catch

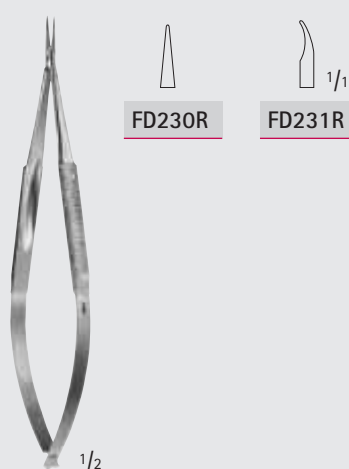

BARRAQUER

**FD230R-FD231R**

ohne Sperre  
without catch  
120 mm, 4 3/4"

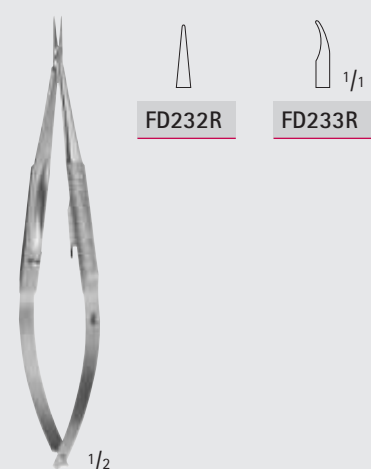

BARRAQUER

**FD232R-FD233R**

mit Sperre  
with catch  
120 mm, 4 3/4"

## Nadelhalter – Needle Holders

### Mikro-Nadelhalter mit Rundgriffen

### Micro Needle Holders with Round Handles

BM

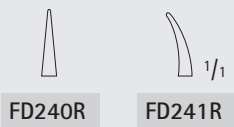
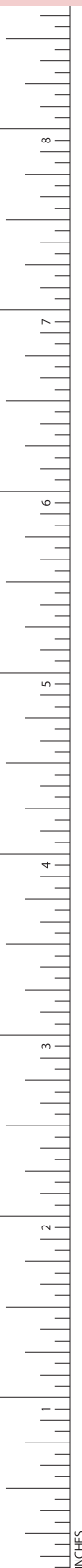

REILL

**FD240R-FD241R**

ohne Sperre  
without catch  
150 mm, 6"

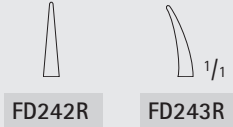

**FD242R-FD243R**

mit Sperre  
with catch  
150 mm, 6"



**FD244R-FD245R**

ohne Sperre  
without catch  
185 mm, 7 1/4"



**FD246R-FD247R**

mit Sperre  
with catch  
185 mm, 7 1/4"

## Nadelhalter – Needle Holders

Mikro-Nadelhalter mit leichtem Kunststoffgriffprofil  
Micro Needle Holders with Lightweight Plastic Handles



### Das MÜLLER Mikro-Instrumentarium

Ein hochwertiges Set für die periphere Mikrochirurgie. Zahlreiche praxisbewährte Details führen zu mehr Effektivität und Sicherheit.

#### ■ Unverkrampte Haltung = mehr Feingefühl

Das leichte Kunststoffprofil vergrößert die Griffoberfläche, gewährleistet dadurch eine unverkrampte Handhaltung und verleiht mehr Feingefühl.

#### ■ Leichteres Drehen = erweiterter Arbeitsbereich

Der runde Griffquerschnitt ermöglicht leichtes, gleichmäßiges Drehen des Instrumentes. Verwendungs- bzw. Arbeitsbereich wird dadurch erweitert.

#### ■ Sicherer Halt

Das griffige Noppenprofil gewährleistet einen durchweg sicheren Halt bei sämtlichen Bewegungsabläufen.

#### ■ Optimales Handling

Eine Entwicklung nach ergonomischen Gesichtspunkten, verbunden mit dem geringen Gewicht der neuen Kunststoffgriffe schaffen die Voraussetzung zu ermüdungsfreiem Arbeiten und optimalem Handling.

### The MÜLLER Micro instrument system

A top quality set for peripheral microsurgery. Numerous details tried and tested in practice mean increased efficiency and safety.

#### ■ Natural holding position = increased sensitivity

The light plastic profile increases the grip surface, thus guaranteeing a natural hand position without cramping and providing enhanced sensitivity.

#### ■ Easier rotation = extended working area

The round grip cross section permits easy and uniform rotation of the instrument. This extends the application and working areas.

#### ■ Safe grip

The easy grip studded profile guarantees a secure hold for all movements.

#### ■ Optimum handling

Development in accordance with ergonomic criteria and the low weight of the new plastic grips provide fatiguefree working and optimum handling.



MÜLLER

FM021R

145 mm, 5 3/4"



MÜLLER

FM061R

180 mm, 7"

# Nadelhalter – Needle Holders

## DUROGRIP® Mikro-Nadelhalter

### DUROGRIP® Micro Needle Holders

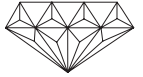

BM

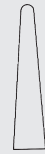
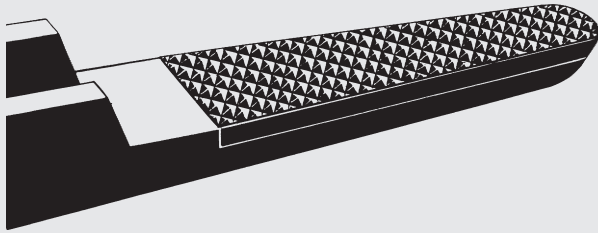

glatt  
smooth



0,2



0,4



0,5

AESCULAP-Nadelhalter sind durch die Struktur der Hartmetall-Maulteile auf das jeweilige, indikationsbezogene Nahtmaterial abgestimmt. Eine glatte Maulfläche sowie 3 verschiedene Haftprofile garantieren den sicheren „Griff“ der jeweiligen Nadel.

AESCULAP needle holders have jaws with carbide inserts and according to the use required the resp. structure can be chosen. A smooth jaw surface as well as 3 different serrations guarantee a sure „grip“ of the resp. needle.

Wir empfehlen Hartmetall-Maulteile mit glatter Fläche für Nahtmaterial mit Teilung 0,2 mm für Nahtmaterial  
0,4 mm  
0,5 mm

9/0 – 11/0  
6/0 – 10/0  
4/0 – 6/0  
bis 3/0

We recommend carbide inserts with smooth jaw surface for suture material with 0.2 mm pitch of serration for suture material  
0.4 mm  
0.5 mm

9/0 – 11/0  
6/0 – 10/0  
4/0 – 6/0  
up to 3/0



### DUROGRIP®-Nadelhalter mit Hartmetall-Plättchen

#### Kennzeichnung:

Vergoldete Ringe, Branchenenden und Sperren

DUROGRIP® Needle Holders with carbide inserts

Identification:

gold-plated rings, handle ends and ratchets



1/1  
mit glattem Maul  
with smooth jaw

1/2

CASTROVIEJO

BM001R

145 mm, 5 3/4"



1/1  
0,2

1/2

CASTROVIEJO

BM002R

145 mm, 5 3/4"



1/1  
0,4

1/2

BM003R

170 mm, 6 3/4"



**Nadelhalter – Needle Holders**  
**DUROGRIP Mikro-Nadelhalter**  
**DUROGRIP Micro Needle Holders**

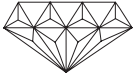

**BM**

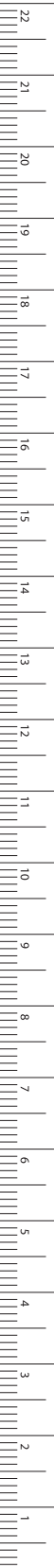

MILLIMETERS



**CASTROVIEJO**

**BM004R**

180 mm, 7"



**CASTROVIEJO**

**BM005R**

215 mm, 8 1/2"



**FM388R**

mit Sperre  
with catch  
180 mm, 7"



**FM390R**

mit Sperre  
with catch  
200 mm, 8"

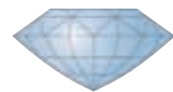

## Nadelhalter – Needle Holders

DIADUST Mikro-Nadelhalter mit Rundgriff

DIADUST Micro Needle Holders with Round Handle

DIADUST



Die Diamantstaubbeschichtung sorgt für eine noch härtere und verschleißfestere Maulinnenfläche. Darüber hinaus garantiert die Struktur der DIADUST-Beschichtung ein zuverlässiges Fassen von feinen Nadeln und Nahtmaterialien sowie von Weichgewebe.

The diamond dust coating ensures an even harder and more wear resistant surface on the inside of the jaws. Moreover, the structure of the DIADUST coating guarantees a reliable grip for fine needles and sutures, as well as for tissue.

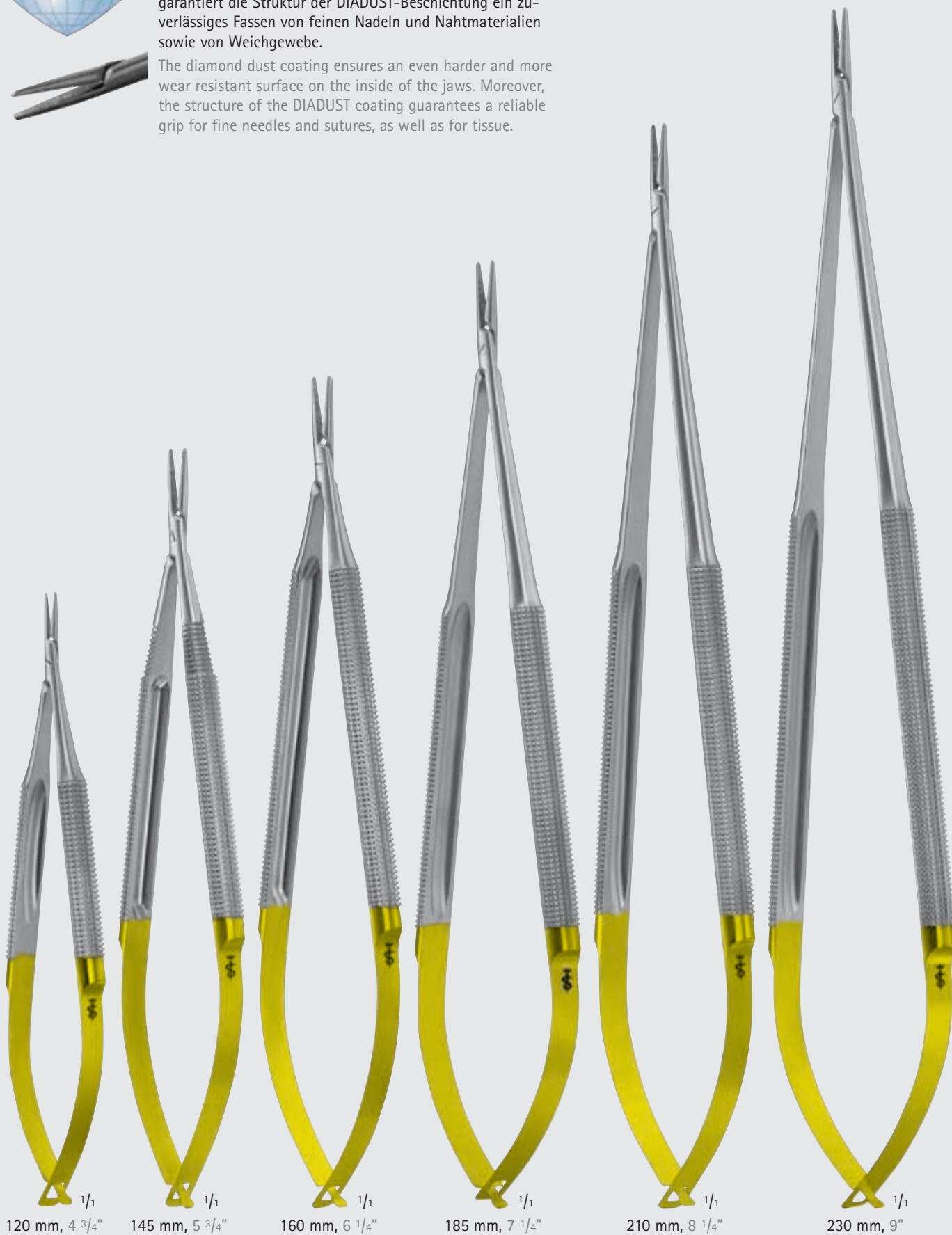

120 mm, 4 3/4" 1/1

145 mm, 5 3/4" 1/1

160 mm, 6 1/4" 1/1

185 mm, 7 1/4" 1/1

210 mm, 8 1/4" 1/1

230 mm, 9" 1/1





DIADUST



## Nadelhalter – Needle Holders

DIADUST Mikro-Nadelhalter mit Rundgriff  
DIADUST Micro Needle Holders with Round Handle

BM

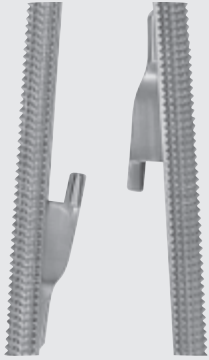

mit Sperre  
with ratchet



Nahtmaterialgröße  
Suture size

Länge (mm) Length (in.)	7/0 und kleiner 7/0 and smaller	5/0 und kleiner 5/0 and smaller	4/0 und kleiner 4/0 and smaller	4/0 und kleiner 4/0 and smaller
120 mm 4 3/4"	<a href="#">FM520R</a>			
145 mm 5 3/4"		<a href="#">FM522R</a>		
160 mm 6 1/4"	<a href="#">FM521R</a>	<a href="#">FM523R</a>		
185 mm 7 1/4"	<a href="#">FM563R</a>	<a href="#">FM564R</a>	<a href="#">FM218R</a>	
210 mm 8 1/4"	<a href="#">FM565R</a>	<a href="#">FM566R</a>	<a href="#">FM228R</a>	<a href="#">FM221R</a>
230 mm 9"	<a href="#">FM567R</a>	<a href="#">FM568R</a>	<a href="#">FM230R</a>	<a href="#">FM223R</a>

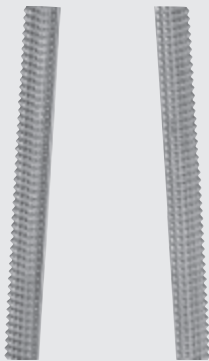

ohne Sperre  
without  
ratchet



Nahtmaterialgröße  
Suture size

Länge (mm) Length (in.)	7/0 und kleiner 7/0 and smaller	5/0 und kleiner 5/0 and smaller
120 mm 4 3/4"	<a href="#">FM524R</a>	
145 mm 5 3/4"		<a href="#">FM528R</a>
160 mm 6 1/4"	<a href="#">FM525R</a>	<a href="#">FM529R</a>
185 mm 7 1/4"	<a href="#">FM526R</a>	<a href="#">FM530R</a>
210 mm 8 1/4"	<a href="#">FM527R</a>	<a href="#">FM531R</a>
230 mm 9"	<a href="#">FM532R</a>	<a href="#">FM533R</a>



MILLIMETERS

## Nadelhalter – Needle Holders

DIADUST Mikro-Nadelhalter mit Rundgriff

DIADUST Micro Needle Holders with Round Handle

DIADUST



Die Diamantstaubbeschichtung sorgt für eine noch härtere und verschleißfestere Maulinnenfläche. Darüber hinaus garantiert die Struktur der DIADUST-Beschichtung ein zuverlässiges Fassen von feinen Nadeln und Nahtmaterialien sowie von Weichgewebe.

The diamond dust coating ensures an even harder and more wear resistant surface on the inside of the jaws. Moreover, the structure of the DIADUST coating guarantees a reliable grip for fine needles and sutures, as well as for tissue.



190 mm, 7 1/2"

230 mm, 9"

250 mm, 10"

BM





DIADUST



## Nadelhalter – Needle Holders DIADUST Mikro-Nadelhalter mit Rundgriff DIADUST Micro Needle Holders with Round Handle

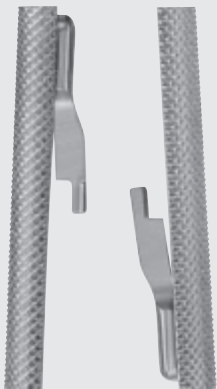

mit Sperre,  
kräftige  
Ausführung  
with ratchet,  
heavy style



Nahtmaterialgröße  
Suture size

Länge (mm)  
Length (in.)

190 mm  
7 1/2"

FM538R

230 mm  
9"

FM539R

250 mm  
10"

FM534R

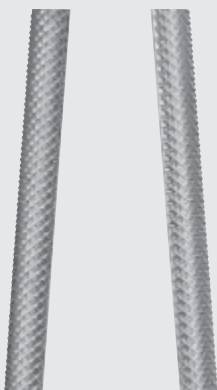

ohne Sperre,  
kräftige  
Ausführung  
without  
ratchet,  
heavy style



Nahtmaterialgröße  
Suture size

Länge (mm)  
Length (in.)

190 mm  
7 1/2"

FM535R

230 mm  
9"

FM536R

250 mm  
10"

FM537R

BM

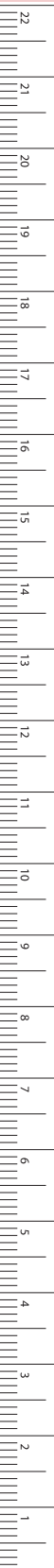

MILLIMETERS

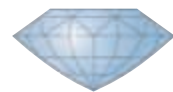

## Nadelhalter – Needle Holders

DIADUST Mikro-Nadelhalter mit Flachgriff

DIADUST Micro Needle Holders with Flat Handles

DIADUST



Die Diamantstaubbeschichtung sorgt für eine noch härtere und verschleißfestere Maulinnenfläche. Darüber hinaus garantiert die Struktur der DIADUST-Beschichtung ein zuverlässiges Fassen von feinen Nadeln und Nahtmaterialien sowie von Weichgewebe.

The diamond dust coating ensures an even harder and more wear resistant surface on the inside of the jaws. Moreover, the structure of the DIADUST coating guarantees a reliable grip for fine needles and sutures, as well as for tissue.



145 mm, 5 <sup>3</sup>/<sub>4</sub>"

170 mm, 6 <sup>3</sup>/<sub>4</sub>"

185 mm, 7 <sup>1</sup>/<sub>4</sub>"

210 mm, 8 <sup>1</sup>/<sub>4</sub>"

230 mm, 9"



DIADUST



## Nadelhalter – Needle Holders

DIADUST Mikro-Nadelhalter mit Flachgriff  
DIADUST Micro Needle Holders with Flat Handles

BM

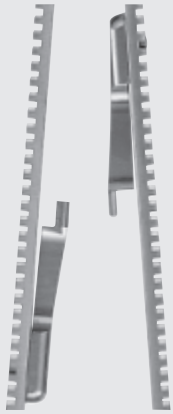

mit Sperre  
with ratchet



Nahtmaterialgröße  
Suture size

Länge (mm) Length (in.)	7/0 und kleiner 7/0 and smaller	5/0 und kleiner 5/0 and smaller
145 mm 5 3/4"		<u>FM541R</u>
170 mm 6 3/4"	<u>FM540R</u>	
185 mm 7 1/4"		<u>FM542R</u>
210 mm 8 1/4"		<u>FM543R</u>
230 mm 9"		<u>FM544R</u>

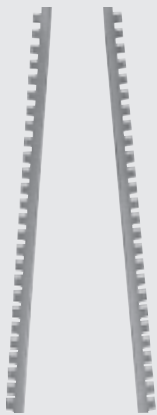

ohne Sperre  
without  
ratchet



Nahtmaterialgröße  
Suture size

Länge (mm) Length (in.)	7/0 und kleiner 7/0 and smaller	5/0 und kleiner 5/0 and smaller
145 mm 5 3/4"		<u>FM546R</u>
170 mm 6 3/4"	<u>FM545R</u>	
185 mm 7 1/4"		<u>FM547R</u>
210 mm 8 1/4"		<u>FM548R</u>
230 mm 9"		<u>FM549R</u>

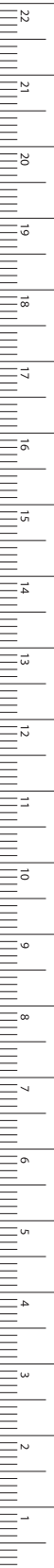

MILLIMETERS

DIADUST

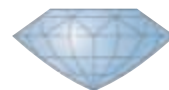

## Nadelhalter – Needle Holders

DIADUST Mikro-Nadelhalter mit Flachgriff

DIADUST Micro Needle Holder with Flat Knurled Handle

DIADUST



Die Diamantstaubbeschichtung sorgt für eine noch härtere und verschleißfestere Maulinnenfläche. Darüber hinaus garantiert die Struktur der DIADUST-Beschichtung ein zuverlässiges Fassen von feinen Nadeln und Nahtmaterialien sowie von Weichgewebe.

The diamond dust coating ensures an even harder and more wear resistant surface on the inside of the jaws. Moreover, the structure of the DIADUST coating guarantees a reliable grip for fine needles and sutures, as well as for tissue.



185 mm, 7 1/4"

210 mm, 8 1/4"

230 mm, 9"

BM





DIADUST



## Nadelhalter – Needle Holders DIADUST Mikro-Nadelhalter mit Flachgriff DIADUST Micro Needle Holders with Flat Knurled Handle

BM



mit Sperre  
with ratchet



Nahtmaterialgröße  
Suture size

Länge (mm)  
Length (in.)

185 mm  
7 1/4"

FM550R

210 mm  
8 1/4"

FM551R

230 mm  
9"

FM552R



ohne Sperre  
without  
ratchet



Nahtmaterialgröße  
Suture size

Länge (mm)  
Length (in.)

185 mm  
7 1/4"

FM553R

210 mm  
8 1/4"

FM554R

230 mm  
9"

FM555R

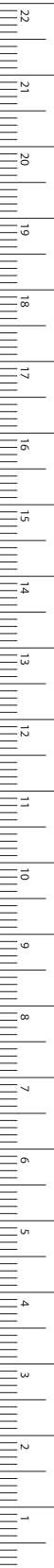

MILLIMETERS

DIADUST



## Nadelhalter – Needle Holders

DIADUST Mikro-Nadelhalter

DIADUST Micro Needle Holders

DIADUST



Die Diamantstaubbeschichtung sorgt für eine noch härtere und verschleißfestere Maulinnenfläche. Darüber hinaus garantiert die Struktur der DIADUST-Beschichtung ein zuverlässiges Fassen von feinen Nadeln und Nahtmaterialien sowie von Weichgewebe.

The diamond dust coating ensures an even harder and more wear resistant surface on the inside of the jaws. Moreover, the structure of the DIADUST coating guarantees a reliable grip for fine needles and sutures, as well as for tissue.



GLASSER

FM560R

Nahtmaterialgröße: 5/0 und kleiner  
Suture size: 5/0 and smaller  
125 mm, 5"



GLASSER

FM561R

Nahtmaterialgröße: 5/0 und kleiner  
Suture size: 5/0 and smaller  
180 mm, 7"

BM







DIADUST



# Nadelhalter – Needle Holders

DIADUST Mikro-Nadelhalter  
DIADUST Micro Needle Holders

BM

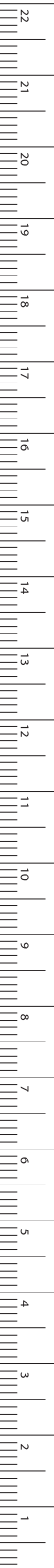

MILLIMETERS



FD258R

FD259R

1/2

FD258R-FD259R

180 mm, 7"



1/1

1/2

FM236R

mit Sperre  
Nahtmaterialgröße: 5/0 und kleiner  
with ratchet  
Suture size: 5/0 and smaller  
210 mm, 8 1/4"



1/1

1/2

FM276R

ohne Sperre  
Nahtmaterialgröße: 5/0 und kleiner  
without ratchet  
Suture size: 5/0 and smaller  
210 mm, 8 1/4"

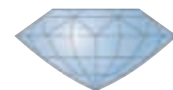

## Nadelhalter – Needle Holders

DIADUST Mikro-Nadelhalter

DIADUST Micro Needle Holders

DIADUST



Die Diamantstaubbeschichtung sorgt für eine noch härtere und verschleißfestere Maulinnenfläche. Darüber hinaus garantiert die Struktur der DIADUST-Beschichtung ein zuverlässiges Fassen von feinen Nadeln und Nahtmaterialien sowie von Weichgewebe.

The diamond dust coating ensures an even harder and more wear resistant surface on the inside of the jaws. Moreover, the structure of the DIADUST coating guarantees a reliable grip for fine needles and sutures, as well as for tissue.



BM301R	BM325R	BM302R	BM327R	BM328R
140 mm	160 mm	180 mm	220 mm	250 mm
5 1/2"	6 1/4"	7"	8 3/4"	10"



RYDER

**BM301R-BM328R**

Nahtmaterialgröße: 5/0 und kleiner

Suture Size: 5/0 and smaller



Nadelhalter – Needle Holders  
Nadelhalter  
Needle Holders

BM

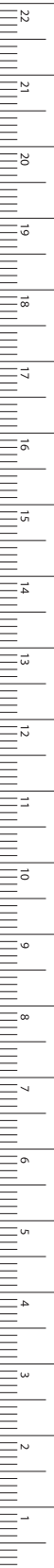

CONVERSE

**BM200R**

130 mm, 5 1/8"



WEBSTER

**BM202R**

125 mm, 5"



HALSEY

**BM201R-BM205R**

130 mm, 5 1/8"



DERF

**BM204R**

125 mm, 5"



DOYEN

**BM210R**

125 mm, 5"



BAUMGARTNER

**BM215R**

145 mm, 5 3/4"

MILLIMETERS

## Nadelhalter – Needle Holders

Nadelhalter  
Needle Holders

BM



CRILE-WOOD

**BM218R**

150 mm, 6"

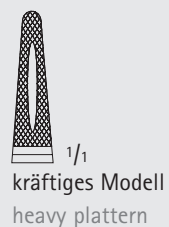
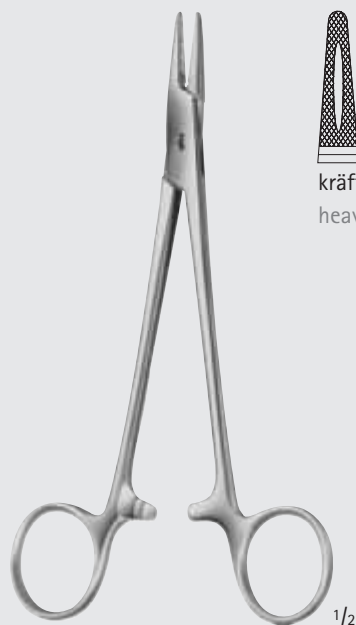

CRILE-WOOD

**BM220R**

160 mm, 6 1/4"

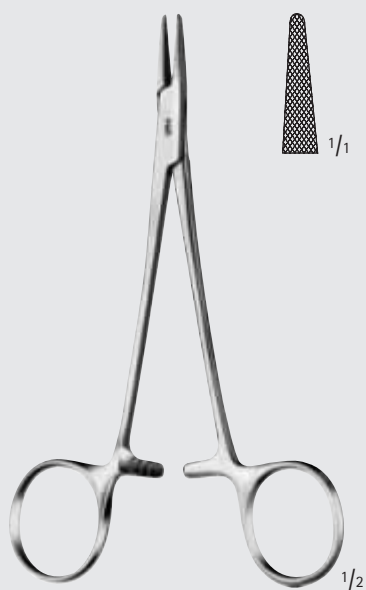

CRILE-MURRAY

**BM219R**

150 mm, 6"



KILNER

**BM211R**

135 mm, 6"



## Nadelhalter – Needle Holders

### Nadelhalter Needle Holders

BM



$\frac{1}{1}$   
feines Maul  
delicate jaw

LAWRANCE

**BM221R**

150 mm, 6"



$\frac{1}{1}$   
 $\frac{1}{1}$

für Frontal-, Gaumennaht  
etc. geeignet  
designed for frontal and  
palate suture

ADSON

**BM224R**

180 mm, 7"

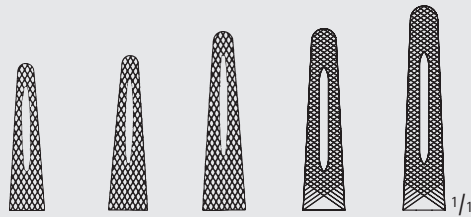

BM235R	BM236R	BM237R	BM238R	BM240R
150 mm	185 mm	200 mm	235 mm	265 mm
6"	7 1/4"	8"	9 1/4"	10 1/2"

MAYO-HEGAR

**BM235R-BM240R**

mittelfeine Modelle  
medium fine patterns

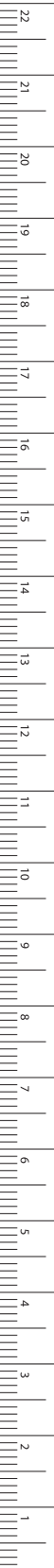

MILLIMETERS

# Nadelhalter – Needle Holders

Nadelhalter  
Needle Holders

BM

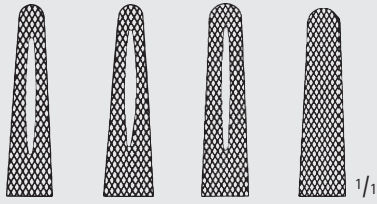

BM245R	BM247R	BM249R	BM255R
150 mm	175 mm	205 mm	205 mm
6"	7"	8"	8"

HEGAR

**BM245R–BM255R**

kräftige Modelle  
heavy patterns

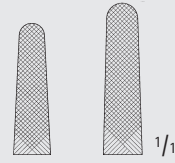

BM241R	BM242R
165 mm	190 mm
6 1/2"	7 1/2"

MAYO-HEGAR

**BM241R–BM242R**

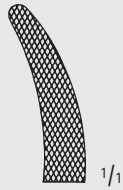

HEANEY

**BM259R**

200 mm, 8"



JAMESON

**BM270R**

230 mm, 9"





Nadelhalter – Needle Holders  
Nadelhalter  
Needle Holders

BM



1/1

1/2

WANGENSTEEN

BM272R

275 mm, 10 3/4"



1/1

1/2

MASSON

BM275R

265 mm, 10 1/2"

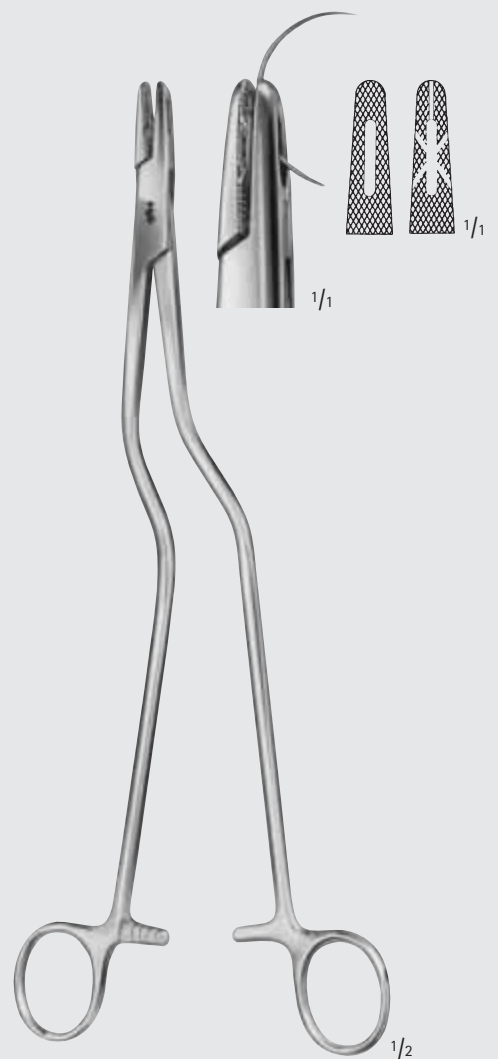

1/1

1/2

MASSON-LUETHY

BM280R

255 mm, 10"



MILLIMETERS

## Nadelhalter – Needle Holders

Nadelhalter mit Schere

Needle Holders with Scissors

BM

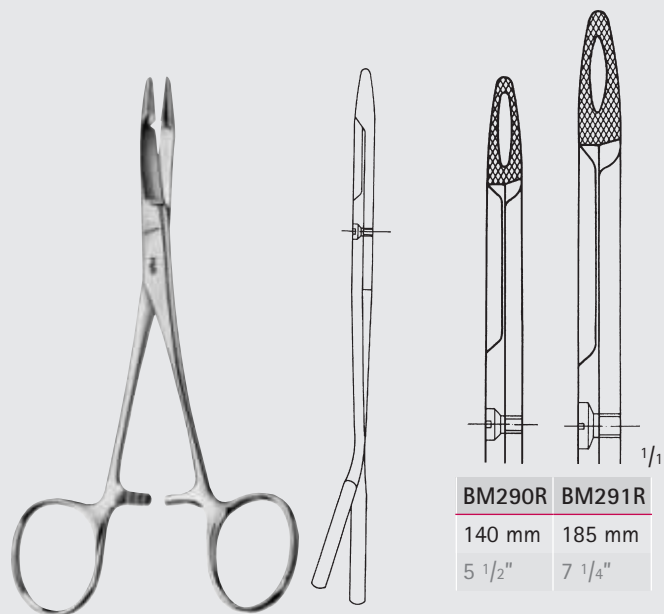

BM290R	BM291R
140 mm	185 mm
5 1/2"	7 1/4"

HEGAR-OLSEN

**BM290R-BM291R**

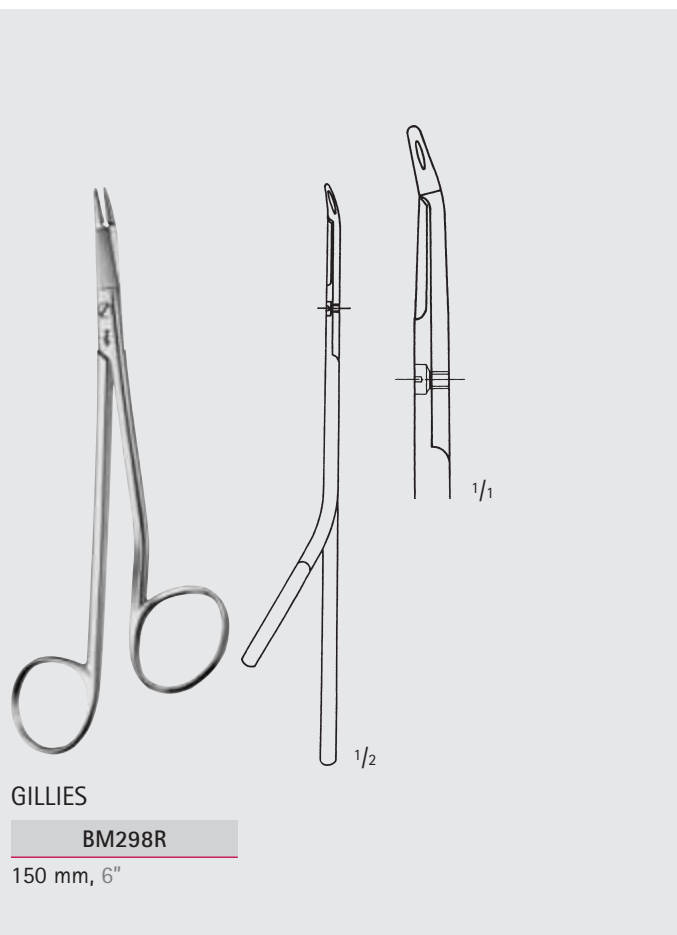

GILLIES

**BM298R**

150 mm, 6"



GILLIES

**BM299R**

160 mm, 6 1/4"







## Nadelhalter – Needle Holders

### Nadelhalter Needle Holders

**BM**

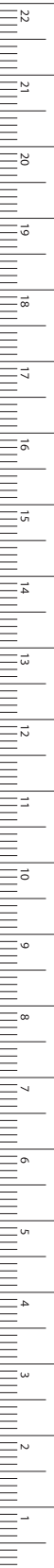

MILLIMETERS



CRILE

**BM503R**

150 mm, 6"



TÖNNIS

**BM510R**

elastisches Modell für Dura- oder Darmnaht  
elastic pattern for dura- or intestinal suture  
180 mm, 7"

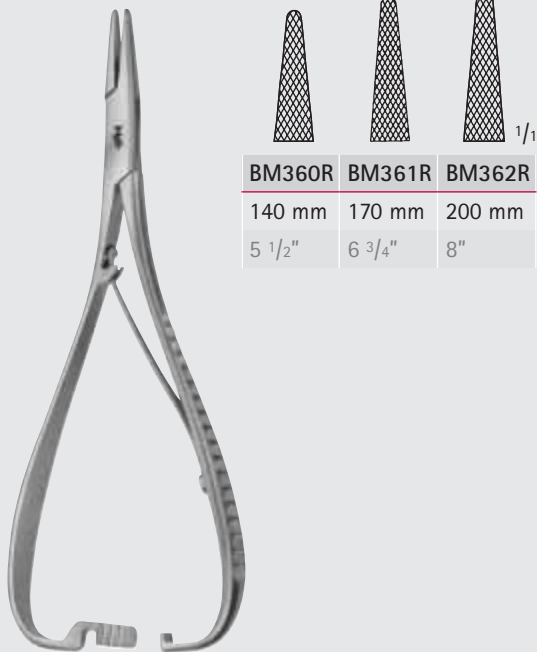

MATHIEU

**BM360R-BM362R**

BM360R	BM361R	BM362R
140 mm	170 mm	200 mm
5 1/2"	6 3/4"	8"



MATHIEU-STILLE

**BM406R-BM407R**

sehr kräftige Modelle  
very heavy patterns

## Nadelhalter – Needle Holders

DUROGRIP® Nadelhalter

DUROGRIP® Needle Holders

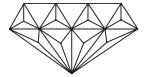

BM

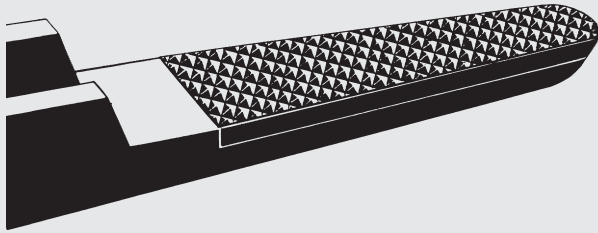

glatt  
smooth



0,2



0,4



0,5

AESULAP-Nadelhalter sind durch die Struktur der Hartmetall-Maulteile auf das jeweilige, indikationsbezogene Nahtmaterial abgestimmt. Eine glatte Maulfläche sowie 3 verschiedene Haftprofile garantieren den sicheren „Griff“ der jeweiligen Nadel.

AESULAP needle holders have jaws with carbide inserts and according to the use required the resp. structure can be chosen. A smooth jaw surface as well as 3 different serrations guarantee a sure „grip“ of the resp. needle.

Wir empfehlen Hartmetall-Maulteile mit glatter Fläche für Nahtmaterial mit Teilung 0,2 mm für Nahtmaterial 0,4 mm 0,5 mm

9/0 – 11/0  
6/0 – 10/0  
4/0 – 6/0  
bis 3/0

We recommend carbide inserts with smooth jaw surface for suture material with 0.2 mm pitch of serration for suture material 0.4 mm 0.5 mm

9/0 – 11/0  
6/0 – 10/0  
4/0 – 6/0  
up to 3/0



**DUROGRIP®-Nadelhalter mit Hartmetall-Plättchen**  
**Kenzeichnung:**

**Vergoldete Ringe, Branchenenden und Sperren**

DUROGRIP® Needle Holders with carbide inserts

Identification:

gold-plated rings, handle ends and ratchets



**Nadelhalter – Needle Holders**  
**DUROGRIP® Nadelhalter**  
**DUROGRIP® Needle Holders**

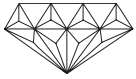

**BM**

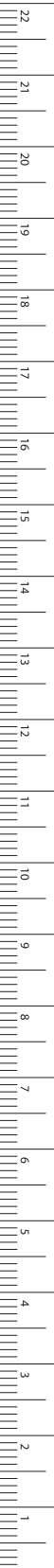

MILLIMETERS

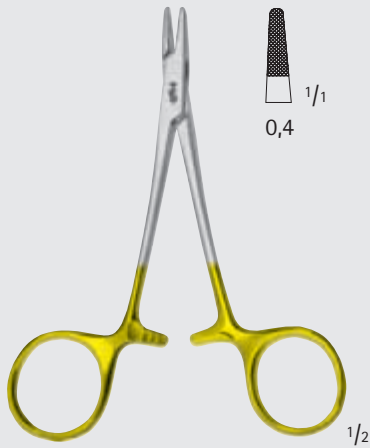

DERF

**BM008R**

115 mm, 4 1/2"



HALSEY

**BM010R**

120 mm, 4 3/4"

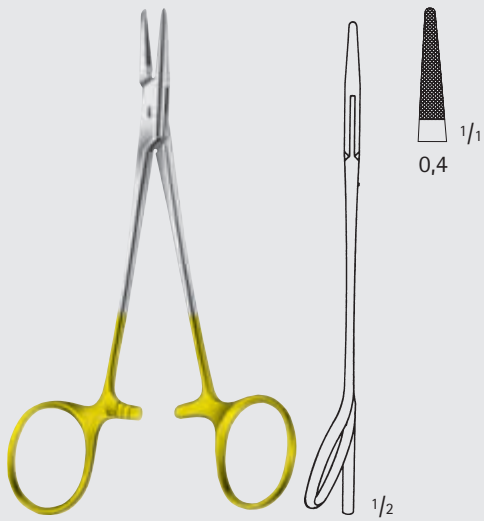

MASING

**BM009R**

ein Ring abgewinkelt  
 one ring angled  
 130 mm, 5 1/8"

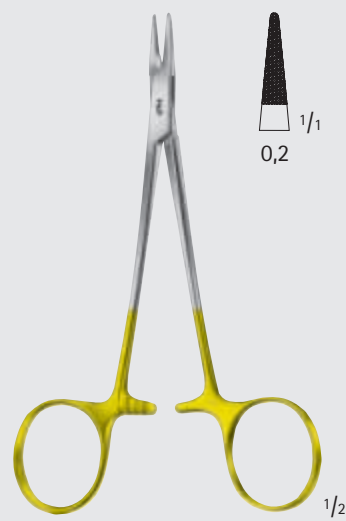

CONVERSE

**BM011R**

130 mm, 5 1/8"

# Nadelhalter – Needle Holders

DUROGRIP® Nadelhalter

DUROGRIP® Needle Holders

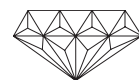

BM

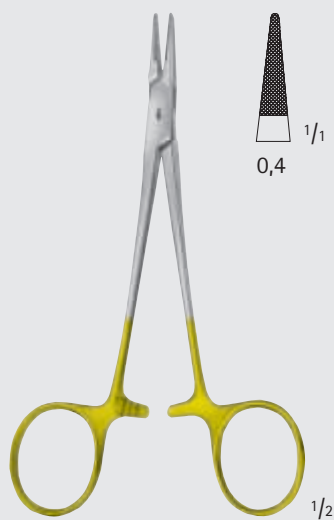

HALSEY

**BM012R**

130 mm, 5 1/8"



**BM014R**

mit glattem Maul

with smooth jaws

**BM024R**

WEBSTER

**BM014R-BM024R**

125 mm, 5"

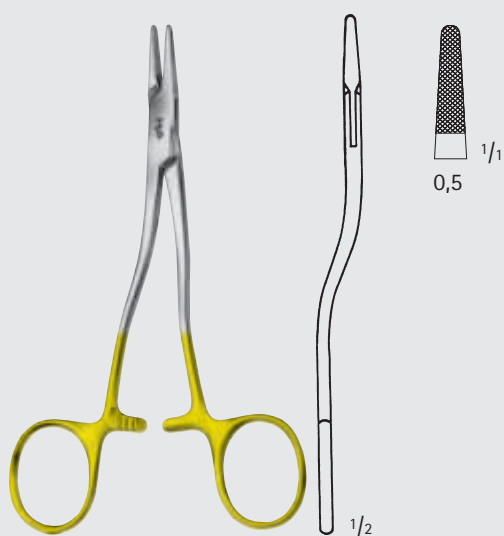

KILNER

**BM018R**

135 mm, 5 1/4"



BAUMGARTNER

**BM015R**

145 mm, 5 3/4"



**Nadelhalter – Needle Holders**  
**DUROGRIP® Nadelhalter**  
**DUROGRIP® Needle Holders**

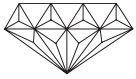

**BM**

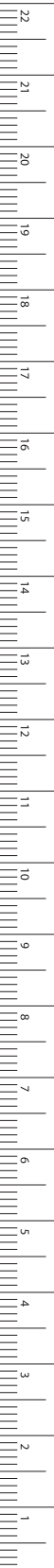

**BABY-CRILE-WOOD**  
**BM013R**  
 150 mm, 6"

BM016R	BM017R	BM019R	BM030R	BM021R
145 mm	185 mm	200 mm	270 mm	305 mm
5 3/4"	7 1/4"	8"	10 3/8"	12 1/2"

**CRILE-WOOD**  
**BM016R-BM030R**

BM020R	BM023R
175 mm	260 mm
7"	10 1/4"

**SAROT**  
**BM020R-BM023R**

**HEGAR-MAYO-SEELEY**  
**BM022R**  
 200 mm, 8"

## Nadelhalter – Needle Holders

DUROGRIP® Nadelhalter

DUROGRIP® Needle Holders

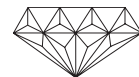

BM



HEGAR-MAYO

**BM065R-BM070R**

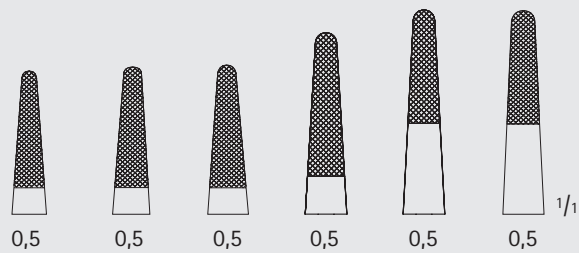

BM065R	BM066R	BM067R	BM068R	BM070R	BM069R
150 mm	185 mm	205 mm	235 mm	265 mm	300 mm
6"	7 1/4"	8"	9 1/4"	10 1/2"	12"

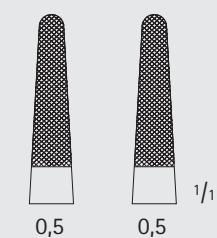

BM077R	BM078R
205 mm	245 mm
8"	9 3/4"

HEGAR

**BM077R-BM078R**

kräftige Modelle  
heavy patterns

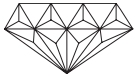

**Nadelhalter – Needle Holders**  
**DUROGRIP® Nadelhalter mit Schere**  
**DUROGRIP® Needle Holders with Scissors**

**BM**

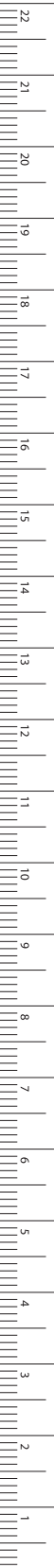

MILLIMETERS



**BM127R**

125 mm, 5"

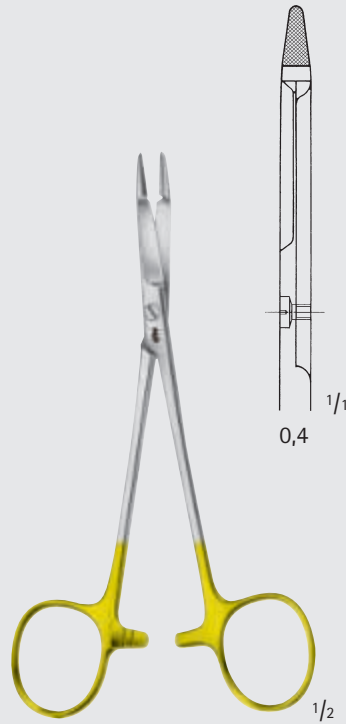

**HEGAR-OLSEN MODIF. LANGE**

**BM128R**

145 mm, 5 3/4"

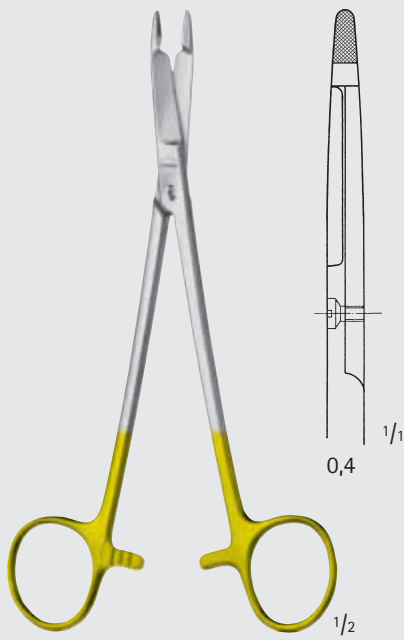

**HEGAR-OLSEN**

**BM124R**

1 Blatt fein gezahnt

1 blade fine serrated

165 mm, 6 1/2"

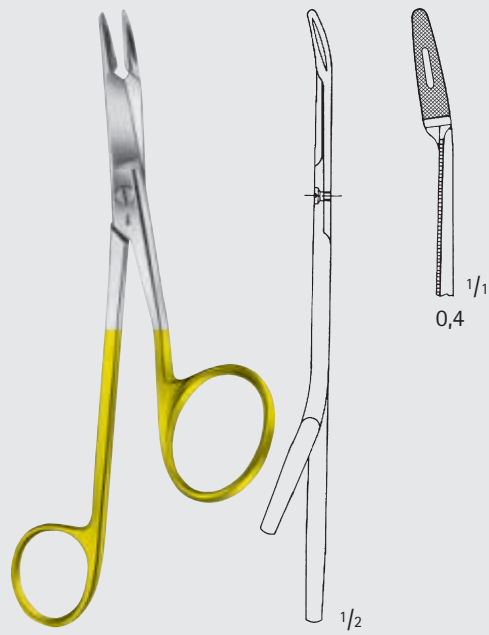

**GILLIES**

**BM129R**

160 mm, 6 1/4"

## Nadelhalter – Needle Holders

DUROGRIP® Nadelhalter, Drahtspannzangen, Ligaturzangen

DUROGRIP® Needle Holders, Wire Twisters, Ligature Forceps

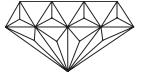

BM



BM110R

150 mm, 6"



BM111R

150 mm, 6"



BAUMGARTNER

BM112R

200 mm, 8"



BM113R

175 mm, 7"



BERRY

MD456R

185 mm, 7 1/4"



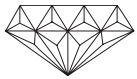

»grazil«

## Nadelhalter – Needle Holders

DUROGRIP® Nadelhalter  
DUROGRIP® Needle Holders

BM

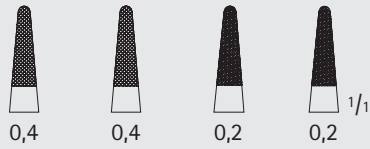

BM033R	BM034R	BM063R	BM064R
165 mm	210 mm	165 mm	210 mm
6 1/2"	8 1/4"	6 1/2"	8 1/4"

DE BAKEY

BM033R-BM064R

sehr fein  
very delicate

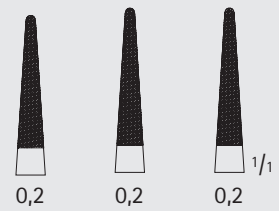

BM025R	BM026R	BM027R
180 mm	200 mm	230 mm
7"	8"	9"

BM025R-BM027R

sehr fein  
very delicate

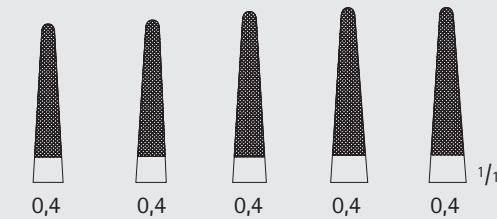

BM032R	BM035R	BM036R	BM037R	BM038R
150 mm	180 mm	230 mm	250 mm	305 mm
6"	7"	9"	10"	12"

DE BAKEY

BM032R-BM038R

1/2



MILLIMETERS

## Nadelhalter – Needle Holders

DUROGRIP® Nadelhalter

DUROGRIP® Needle Holders

»grazil«

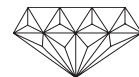

BM



DE BAKEY

**BM040R**

schlankes Modell  
slender pattern

305 mm, 12"

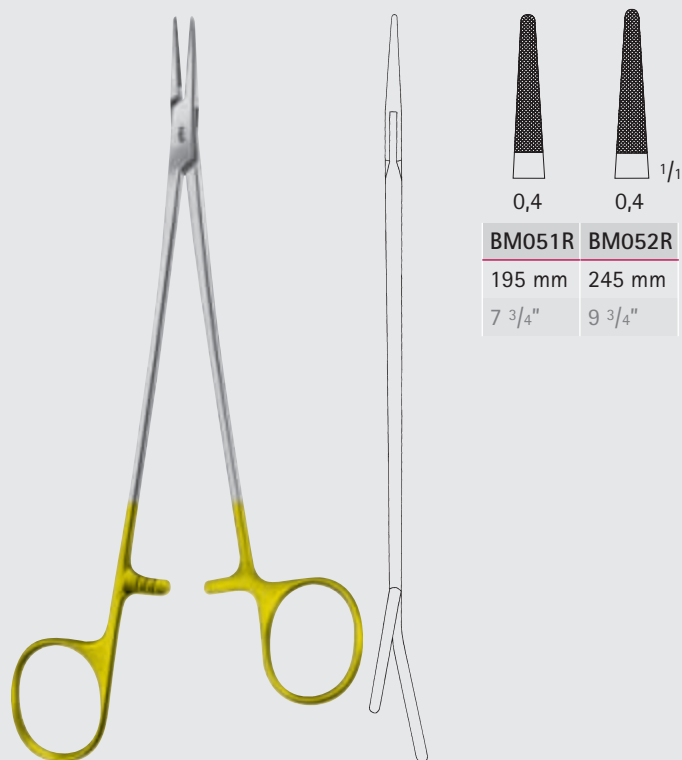

DE BAKEY

**BM051R-BM052R**

Ringe griffgünstig abgesetzt  
und gebogen  
one extended handle and curved  
rings ensure optimum grip



## Nadelhalter – Needle Holders

### DUROGRIP® Nadelhalter

### DUROGRIP® Needle Holders

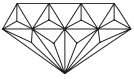

BM100R	BM101R	BM102R
200 mm	240 mm	300 mm
8"	9 1/2"	12"

0,5 0,5 0,5 1/1

**WERTHEIM**  
BM100R-BM102R

BM095R	BM096R
210 mm	230 mm
8 1/4"	9"

0,5 0,5 1/1

**STRATTE**  
BM095R-BM096R

BM081R	BM084R
200 mm	260 mm
8"	10 1/4"

0,5 0,5 1/1

**HEANEY**  
BM081R-BM084R

0,5 1/1

**BM082R**  
S-förmig gebogen  
S-shaped  
215 mm, 8 1/2"

**BM**

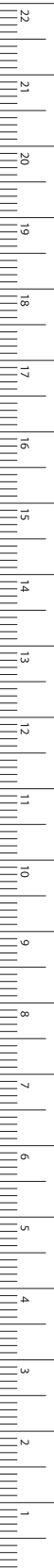

MILLIMETERS

## Nadelhalter – Needle Holders

DUROGRIP® Nadelhalter

DUROGRIP® Needle Holders

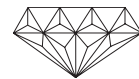

BM





**Nadelhalter – Needle Holders**  
DUROGRIP® Nadelhalter  
DUROGRIP® Needle Holders

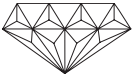

**BM**

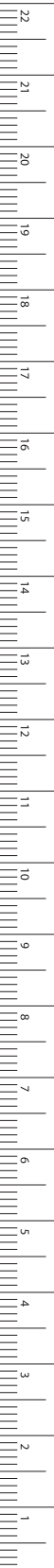

MILLIMETERS



**NAUNTUN-MORGAN**

**BM088R**

260 mm, 10 1/2"



**MÜLLER**

**BM089R**

für tiefe Rektumchirurgie  
for deep rectum surgery  
360 mm, 14"

## Nadelhalter – Needle Holders

DUROGRIP® Nadelhalter

DUROGRIP® Needle Holders

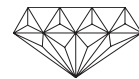

BM



MASSON

BM090R

265 mm, 10 1/2"



FINOCHIETTO

BM092R

265 mm, 10 1/2"



## Nadelhalter – Needle Holders

### DUROGRIP® Nadelhalter

### DUROGRIP® Needle Holders

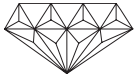

Diese Spezialmodelle mit extra schmalen Mäulern eignen sich für atraumatische Nadeln und für feine Gefäßnadeln.

These special patterns with extremely fine jaws are suitable for holding non-traumatic needles and fine vein needles.

**BM**

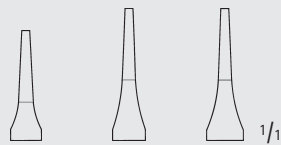

BM074R	BM075R	BM076R
150 mm	180 mm	230 mm
6"	7"	9"

**RYDER**

**BM074R-BM076R**

mit glattem Maul  
with smooth jaws



1/2

**BM184R**

200 mm, 8"

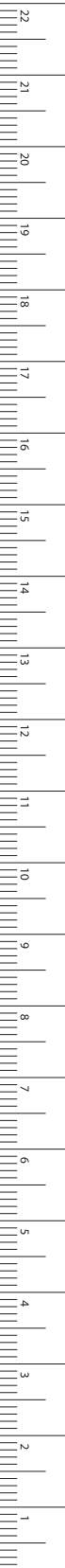

MILLIMETERS

## Nadelhalter – Needle Holders

DUROGRIP® Nadelhalter

DUROGRIP® Needle Holders

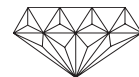

Diese Spezialmodelle mit extra schmalen Mäulern eignen sich für atraumatische Nadeln und für feine Gefäßnadeln.

These special patterns with extremely fine jaws are suitable for holding non-traumatic needles and fine vein needles.

»grazil«

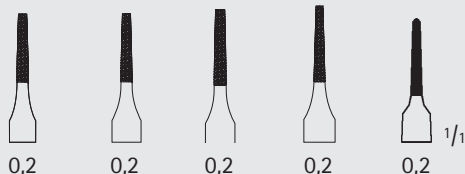

BM054R	BM055R	BM056R	BM057R	BM058R
135 mm	155 mm	175 mm	210 mm	230 mm
5 1/4"	6"	7"	8 1/4"	9"

RYDER

**BM054R-BM058R**

sehr fein

very delicate

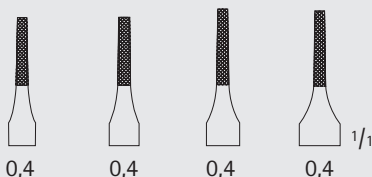

BM044R	BM045R	BM046R	BM047R
135 mm	175 mm	195 mm	265 mm
5 1/4"	7"	7 3/4"	10 1/2"

RYDER

**BM044R-BM047R**



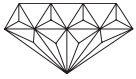

## Nadelhalter – Needle Holders

DUROGRIP® Nadelhalter, ergonomische Griff-Form  
DUROGRIP® Nadelhalter, Ergonomic Handle

Diese Instrumente bieten dem Chirurgen ein Maximum an ergonomischem Komfort. Das optimierte Design der Instrumente ermöglicht ein ermüdungsfreies Arbeiten insbesondere bei schwierigen Naht- und Anastomostechiken.

These instruments provide the surgeon with a maximum of ergonomic comfort. The optimized design of the Instruments offers a fatigue-free working especially with regard to difficult suture and anastomosis techniques.

BM

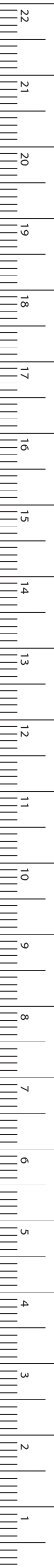

MILLIMETERS

HELLBERG-KUPKA  
**BM320R**  
mit Anreicherungssperre  
with locking ratchet  
210 mm, 8 1/4"

REIN-KUPKA  
**BM310R**  
ohne Sperre  
without ratchet  
190 mm, 7 1/2"

REIN-KUPKA  
**BM311R**  
mit Sperre  
with ratchet  
190 mm, 7 1/2"

## Nadelhalter – Needle Holders

DUROGRIP® Nadelhalter

DUROGRIP® Needle Holders

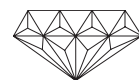

BM



1/2

TÖNNIS

**BM186R**

elastisches Modell

elastic pattern

180 mm, 7"



1/2

TÖNNIS MODIF.

**BM183R**

elastisches Modell

elastic pattern

180 mm, 7"

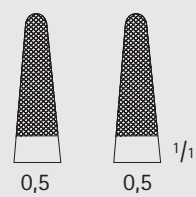

BM191R	BM193R
180 mm	200 mm
7"	8"

LANGENBECK

**BM191R-BM193R**



1/2

»grazil«

LANGENBECK

**BM196R**

200 mm, 8"



**Nadelhalter – Needle Holders**  
**DUROGRIP® Nadelhalter**  
**DUROGRIP® Needle Holders**

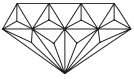

**BM**

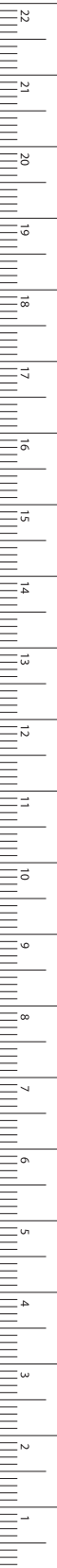

MILLIMETERS



ZWEIFEL

**BM170R**

200 mm, 8"



ZWEIFEL

**BM172R**

200 mm, 8"

kräftiges Modell  
für Sternumnaht  
heavy pattern  
for sternum suture



AESCALAP

**BM178R**

200 mm, 8"

## Nadelhalter – Needle Holders

DUROGRIP® Nadelhalter

DUROGRIP® Needle Holders

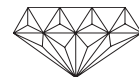

BM



»grazil«



LICHTENBERG

BM132R

elastisches Modell  
elastic pattern

195 mm, 7 3/4"



BM165R

mit langem Hals  
with long neck  
205 mm, 8"



HÖSEL

BM168R

mit langem Hals  
with long neck  
260 mm, 10"



**Nadelhalter – Needle Holders**  
**DUROGRIP® Nadelhalter**  
**DUROGRIP® Needle Holders**

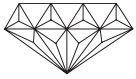

»grazil«

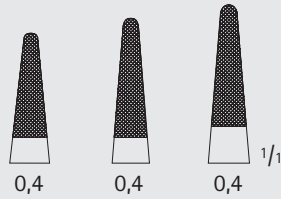

BM148R	BM150R	BM153R
140 mm	170 mm	200 mm
5 1/2"	6 3/4"	8"

MATHIEU

**BM148R–BM153R**

feine Modelle  
 delicate patterns

**BM**

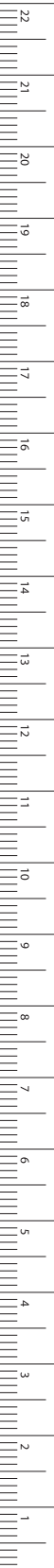

MILLIMETERS

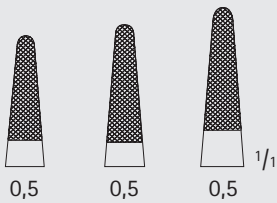

BM149R	BM151R	BM154R
140 mm	170 mm	200 mm
5 1/2"	6 3/4"	8"

MATHIEU

**BM149R–BM154R**

Standard-Modelle  
 Standard patterns

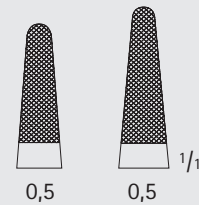

BM156R	BM158R
200 mm	245 mm
8"	9 3/4"

MATHIEU

**BM156R–BM158R**

kräftige Modelle  
 heavy patterns



## Nadelhalter – Needle Holders

Bumerang-Nadelhalter

Boomerang Needle Holders

BM



BM627R



BM628R



BM629R

BM627R-BM629R

Ersatz-Nadeln

Spare needles



1/2

YOUNG-HRYNTSCHAK

BM620R

Bumerang-Nadelhalter  
mit 1 Nadel BM627R  
Boomerang Needle Holder  
with 1 needle BM627R  
240 mm, 9 1/2"



1/2

MILLIN

EF168R

Fadenhaltezange  
Ligature holding forceps  
285 mm, 9 3/4"